

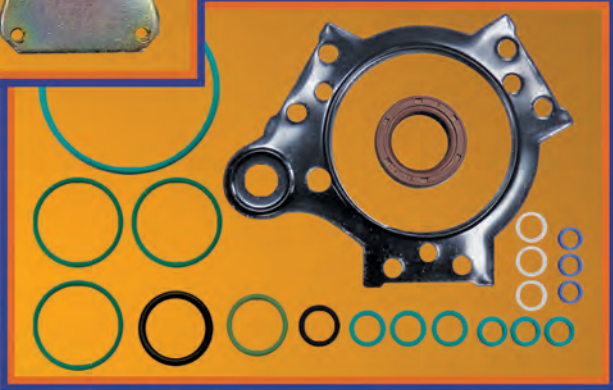

OMS srl

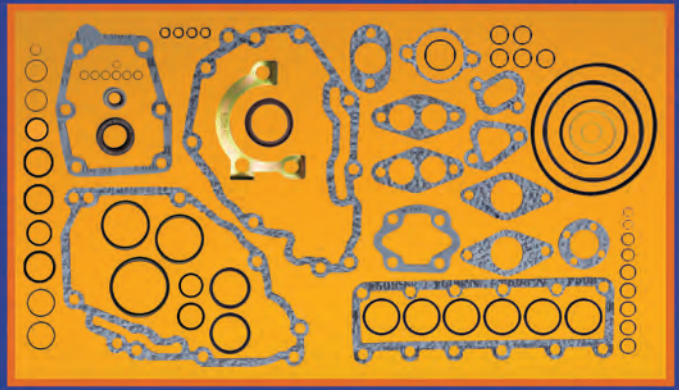

COMMON RAIL & DIESEL INJECTION
SPARE PARTS

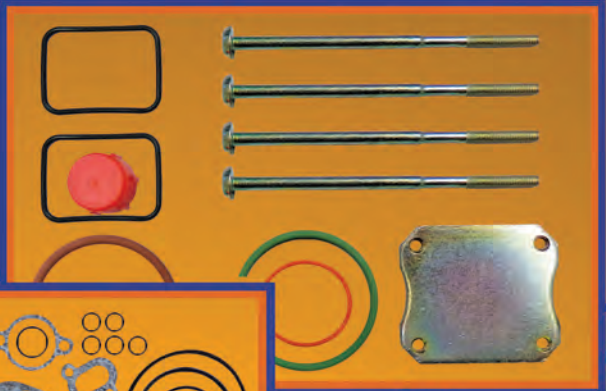

CATALOGO KIT KIT CATALOGUE

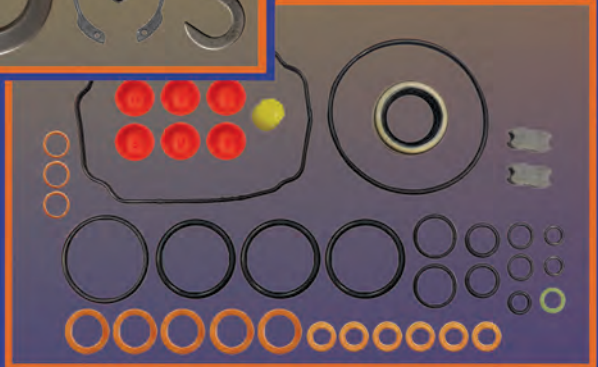
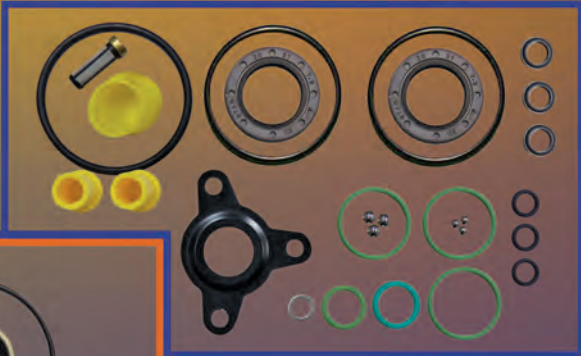
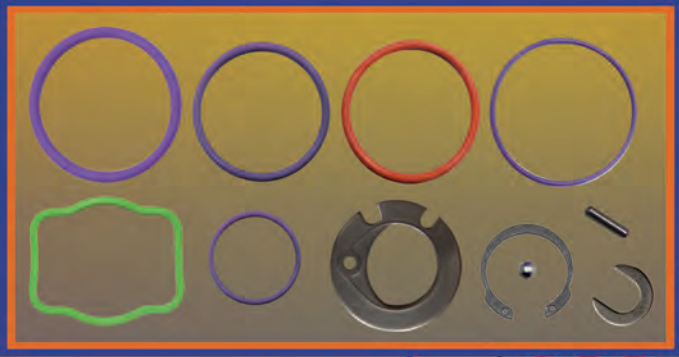

VERSIONE
14.1 2014

OMS srl

COMMON RAIL & DIESEL INJECTION
SPARE PARTS

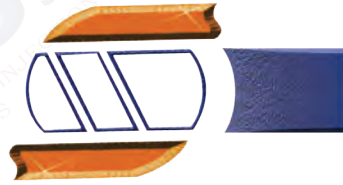

OMS srl è la continuazione della ditta individuale Scalvini nata nel 1977 forte dell'esperienza maturata nella storica OMAP Spa.

I primi anni si afferma a livello mondiale con iniziale gamma di ricambi per pompe iniezione motori diesel.

Oggi OMS srl è presente in 60 paesi del mondo con un notevole impulso all'espansione data dalle nuove gamme di ricambi di common rail iniziate nel 2008.

L'intero ciclo produttivo viene svolto completamente in Italia da uno staff altamente qualificato con particolare attenzione a qualità, garanzia del prodotto e assistenza tecnica.

I clienti di riferimento sono i più eterogenei; dal mercato ricambi indipendente (aftermarket) al ricambio originale (OES) fino al primo impianto (OEM).



OMS srl is a continuation of individual OMS Scalvini born in 1977, based on a good experience in OMAP Spa and deep knowledge of diesel spare parts for fuel injection.

In the first OMS was well know in domestic market, now is present in 60 Countries of the world with diesel spare parts and from 2008 with complete range of common rail spare parts.

OMS products are distinguished by their total interchangeability in terms of assembly and performance, using original products and offering total reliability guaranteed by stringent testing.

The entire industrial process is carried out in house, each step in the process being overseen by highly trained staff.

The customers are in the most heterogenous from independent aftermarket to the original equipment suppliers (OES) to original equipment manufacturer (OEM).



CONDIZIONI DI VENDITA

PREZZI

I prezzi si intendono per merce resa franco nostri magazzini.
L'imballaggio viene addebitato al costo.

PAGAMENTI

I pagamenti verranno concordati al momento dell'ordine.
I pagamenti devono essere effettuati nei termini stabiliti.
Non si accettano sconti non concordati preventivamente.
Eventuali contestazioni non danno diritto alla sospensione dei pagamenti.
Sui pagamenti non effettuati alla scadenza, decorreranno gli interessi di mora.

SPEDIZIONI

La merce viaggia sempre a rischio e pericolo del committente anche se venduta franco destino.
Non indicando all'ordine il mezzo di spedizione, questa verrà da noi effettuata nel modo ritenuto più idoneo, senza alcuna responsabilità da parte nostra.
Trascorsi otto giorni dall'arrivo della merce al destinatario, questa si intende pienamente accettata.
Gli eventuali difetti della merce, contestati solo per iscritto nel termine suddetto e riconosciuto dalla venditrice, obbligano la stessa alla sola sostituzione alle medesime condizioni del contratto, con l'esclusione di ogni e qualsiasi risarcimento, rimborso, spesa, trasporto, annullamento e riduzione di contratto.

CONTROVERSIA

Per ogni eventuale controversia il foro competente è quello di Brescia.



TERMS OF SALE

PRICES

Our prices are F.O.B our warehouse.
The cost of packing is care of the customer.

TERMS OF PAYMENT

The payments will be agreed at time of order.
The terms of payment must be respected.
Discounts are not accepted if not previously agreed on with us.
Any possible disputed can not suspend the payments.
Arrears with payment will be charged for delayed payment.

SHIPMENT

Goods are carried at the consigno's and means of shipping will be chosen by us if not specified in advance by the customers.
Firm do not accept any return of goods late than 8 days within receipt of the same and order will be replaced.
Lower price discount and cancelled order are not accepted.

CONTROVERSY

For any dispute the competent law-court will be Brescia.

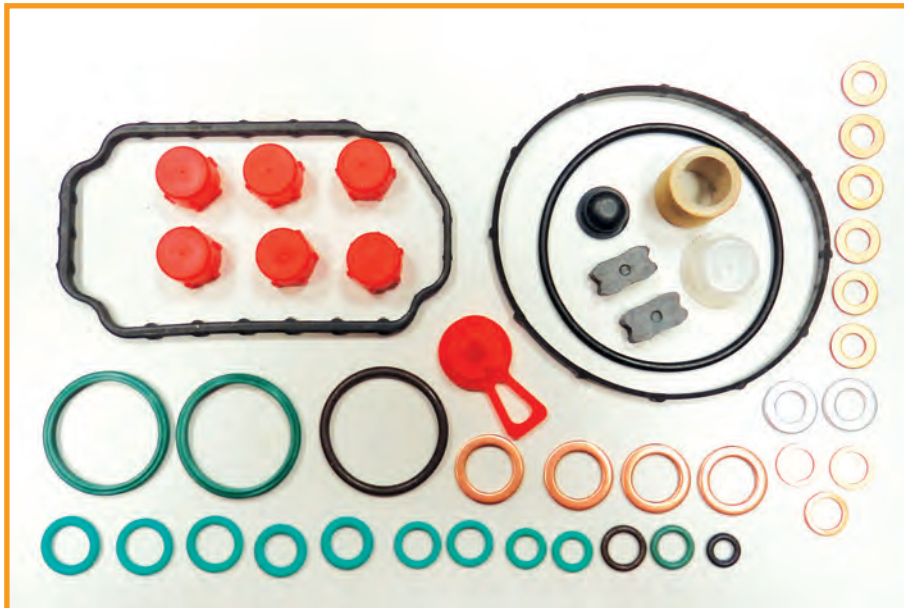

CODICE OMS 10-15-001

COD. Bh 1 467 010 059

COD. Lucas 7135-170

COD.

COD.

TIPO-TYPE EP VE VA

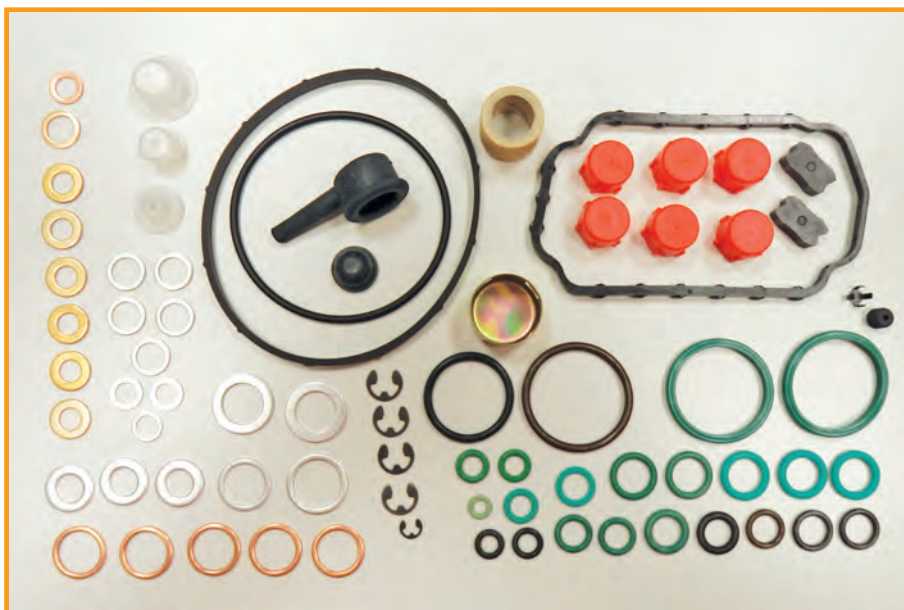

CODICE OMS 10-15-002

COD. Bh 1 467 010 467

COD. Lucas 7135-467

COD.

COD.

TIPO-TYPE EP VE/F...LDA

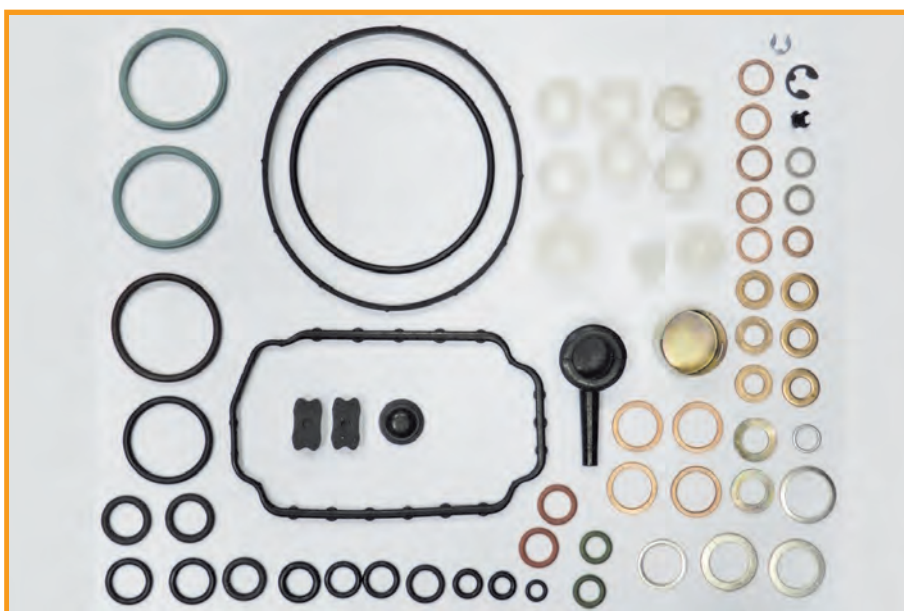

CODICE OMS 10-15-002/1

COD. Bh 1 467 010 467

COD.

COD.

COD.

TIPO-TYPE



CODICE OMS 10-15-003

COD. Bh 1 467 010 050

COD.

COD.

COD.

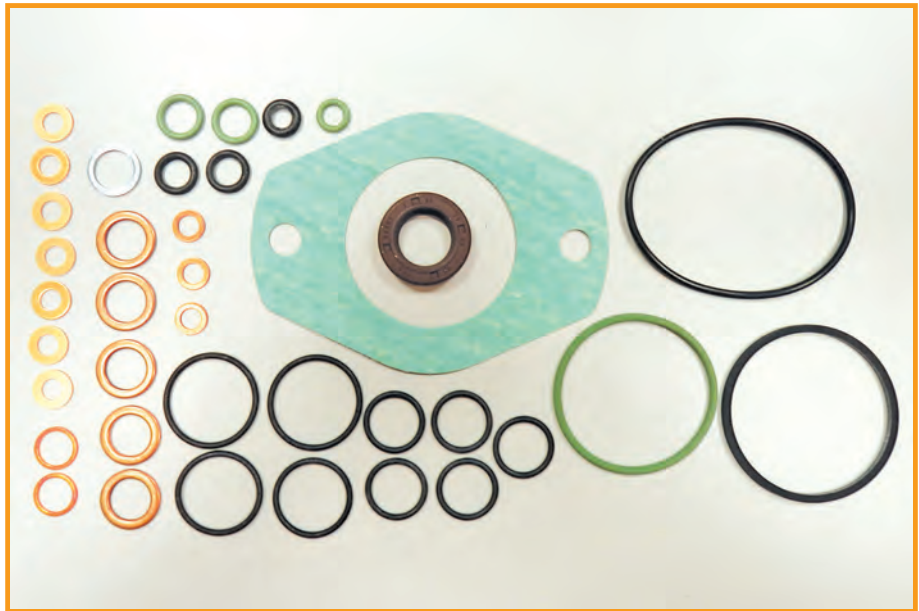

TIPO-TYPE EP- VA

CODICE OMS 10-15-004

COD. Bh 1 467 010 036

COD. Lucas 7135-169

COD.

COD.



TIPO-TYPE EP-VA..C..

CODICE OMS 10-15-004/1

COD. Bh 1 467 010 036/1

COD.

COD.

COD.



TIPO-TYPE EP-VA..C..



CODICE OMS 10-15-005

COD. Bh 1 467 010 520

COD. Lucas 7135-392

COD.

COD.

Paraolio 20x31x7,3

TIPO-TYPE VE

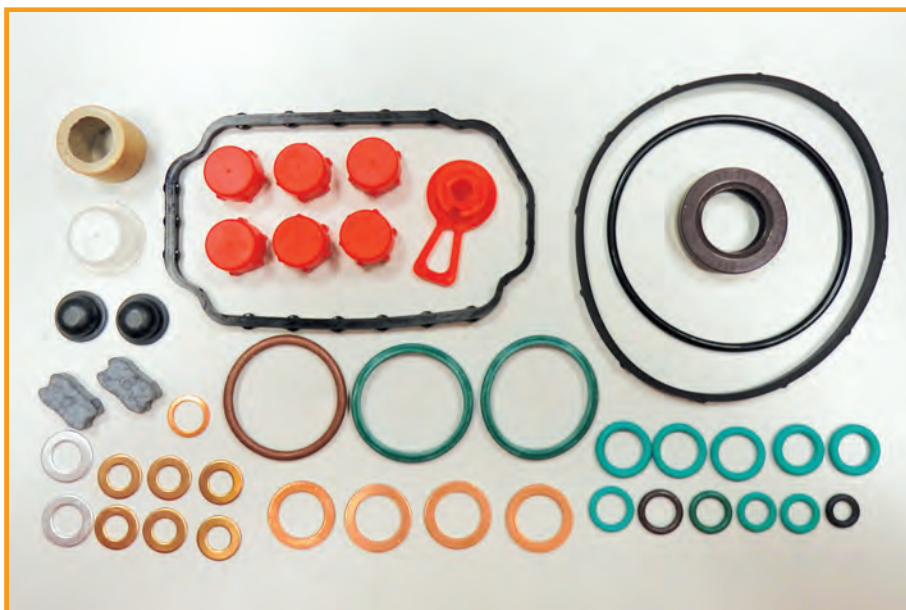

CODICE OMS 10-15-006

COD. Bh 1 467 010 517

COD. Lucas 7135-391

COD.

COD.

Paraolio 17x28x7,3

TIPO-TYPE VE

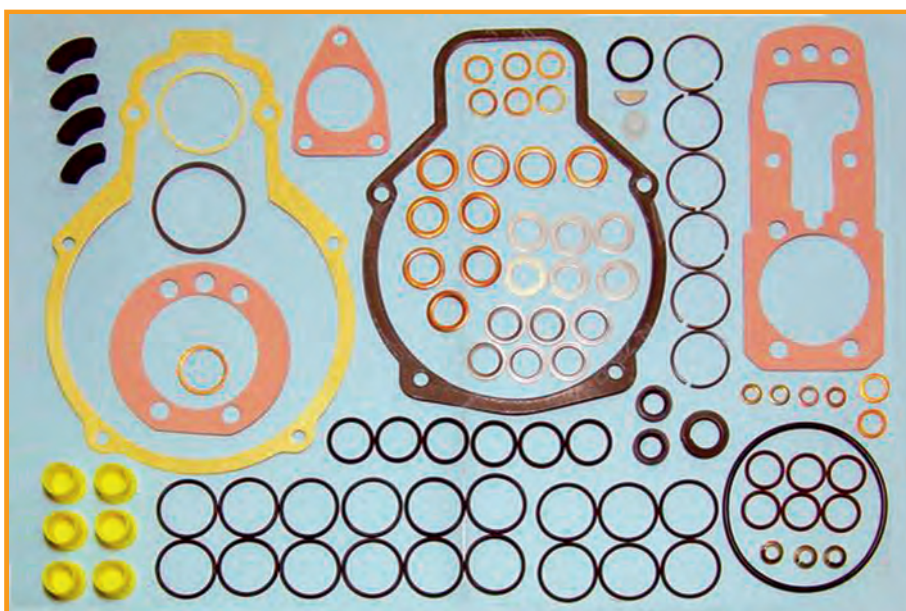

CODICE OMS 10-15-008

COD. Bh 9 413 369 999

COD.

COD.

COD.

TIPO-TYPE F/MATER P76



CODICE OMS 10-15-008/1

COD. Bh 9 413 369 999

COD.

COD.

COD.

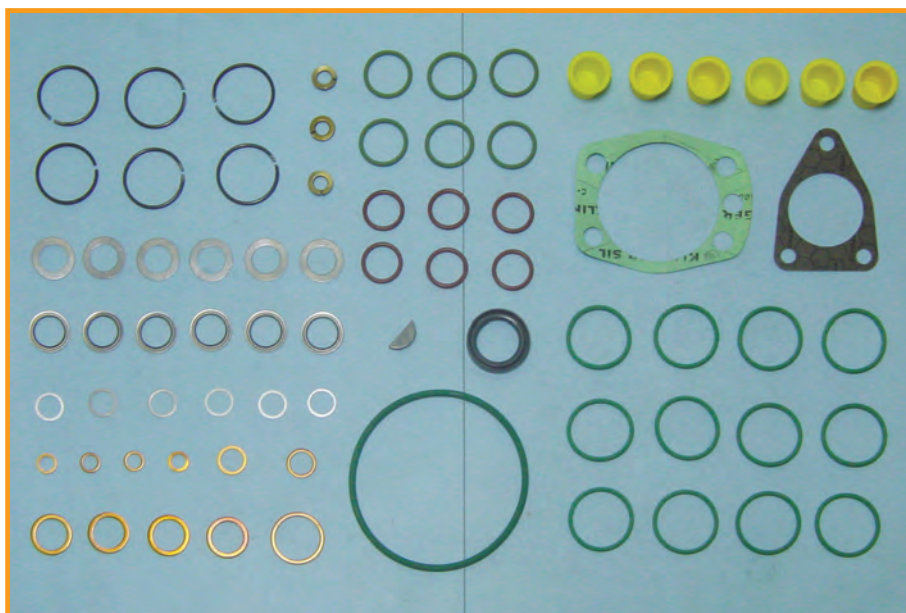

TIPO-TYPE

CODICE OMS 10-15-010

COD. Bh 1 417 010 012

COD. Mercedes 250D

COD.

COD.

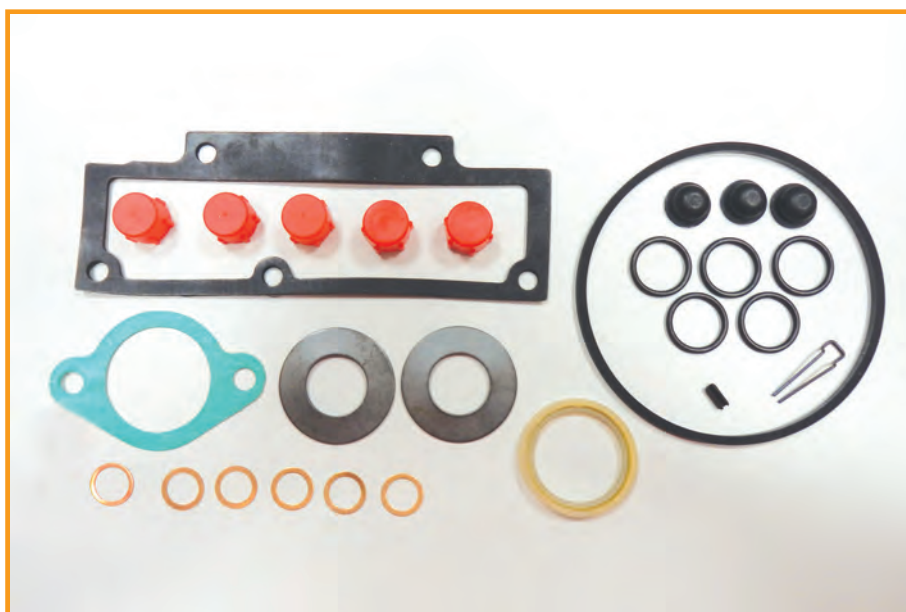

TIPO-TYPE

CODICE OMS 10-15-011

COD. Bh 1 417 010 013

COD. Mercedes 6 cil.

COD.

COD.

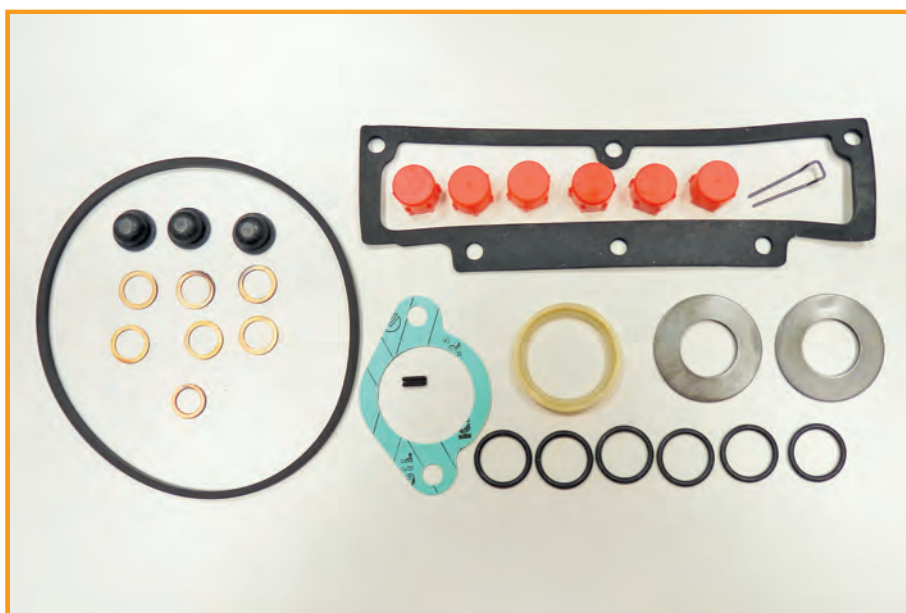

TIPO-TYPE

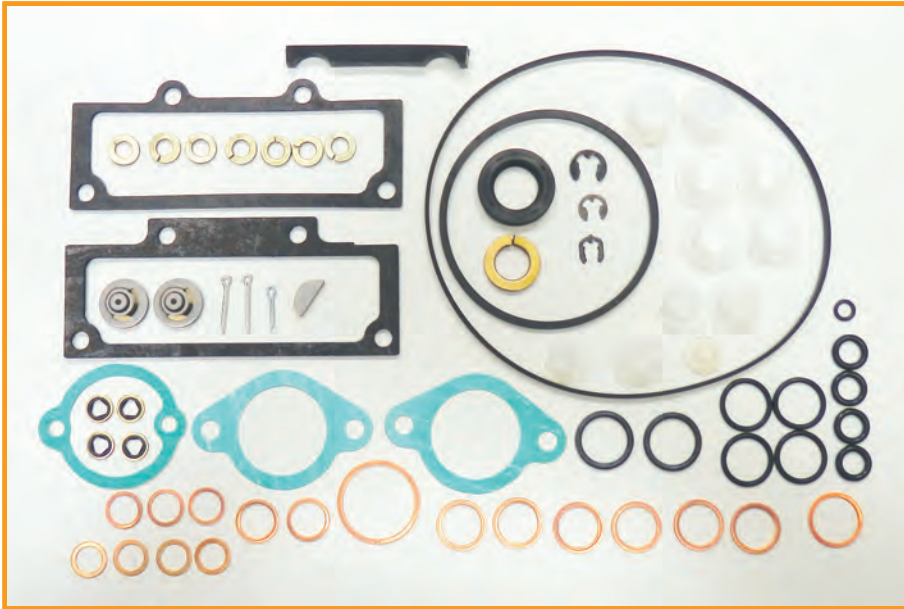

CODICE OMS 10-15-012

COD. Bh 1 417 010 001

COD. Mercedes 200-220D

COD.

COD.

TIPO-TYPE PE(S) 4M..+MN,FP

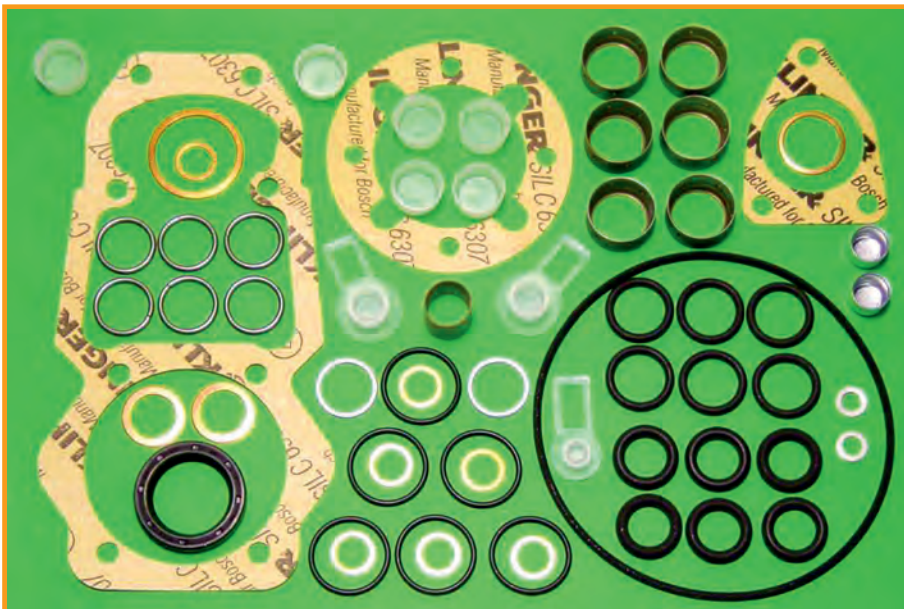

CODICE OMS 10-15-013

COD. Bh 1 467 010 004

COD. Lucas 7135-373

COD.

COD.

TIPO-TYPE PE(S) 6W..Std.+RS/RQV

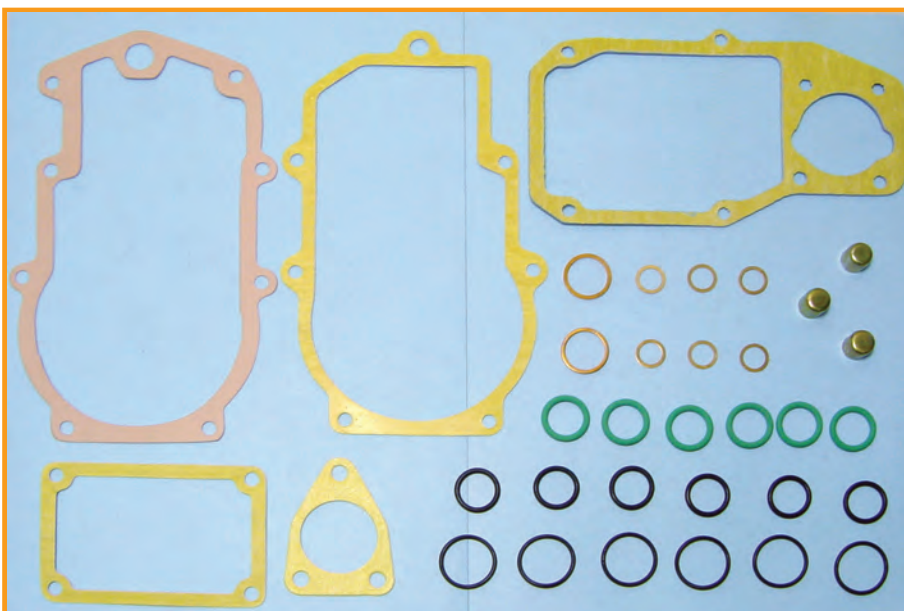

CODICE OMS 10-15-013/1

COD. Bh 1 467 010 004/1

COD.

COD.

COD.

TIPO-TYPE

CODICE OMS 10-15-014

COD. Bh 2 417 010 001/A

COD. Lucas 7135-165

COD.

COD.

Con guarnizioni Lobo

 2 Anelli tenuta $\varnothing 25 \times \varnothing 35 \times 7$ $\varnothing 17 \times \varnothing 28 \times 7$

TIPO-TYPE PE in Viton

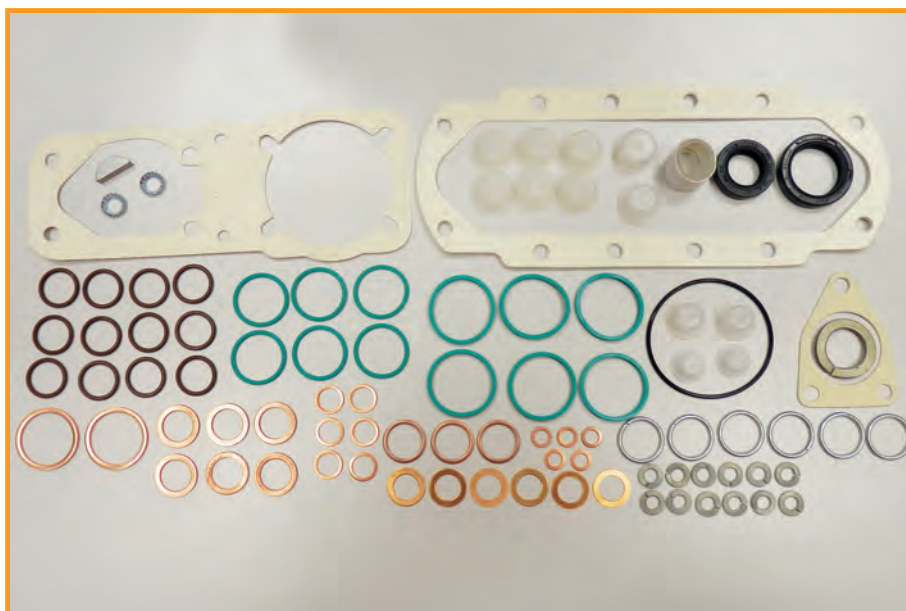
CODICE OMS 10-15-014/1

COD. Bh 2 417 010 001/B

COD. Lucas 7135-165

COD. Tipo economico

COD.

Con guarnizioni Lobo

 2 Anelli tenuta $\varnothing 25 \times \varnothing 35 \times 7$ $\varnothing 17 \times \varnothing 28 \times 7$

TIPO-TYPE PE in NBR

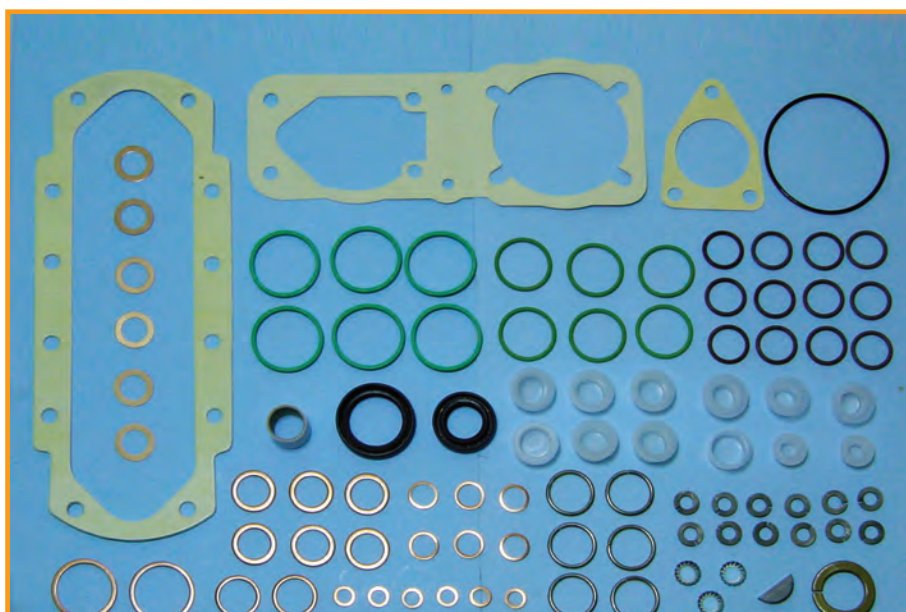
CODICE OMS 10-15-014/2

COD. Bh 2 417 010 001/C

COD.

COD.

COD.

TIPO-TYPE PE/S)..6P..

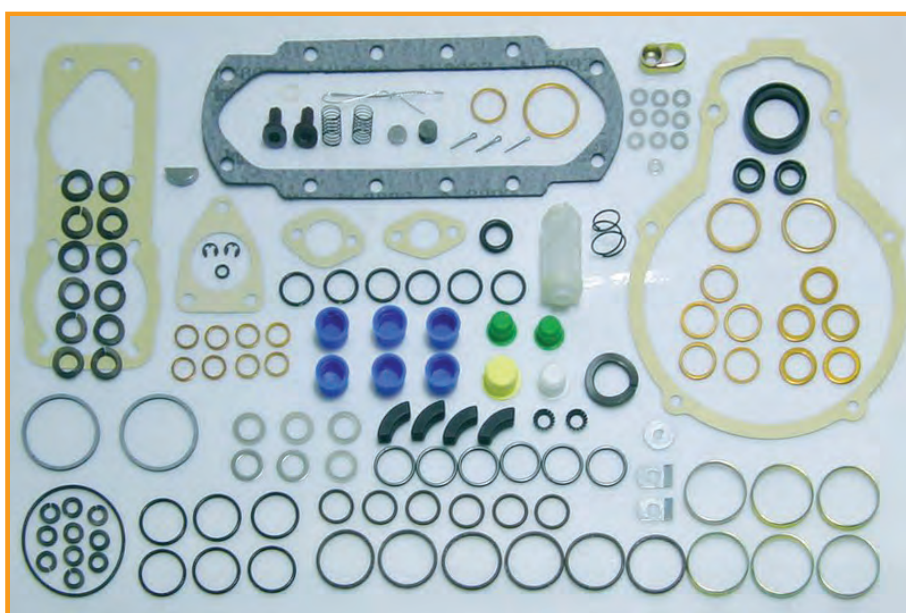

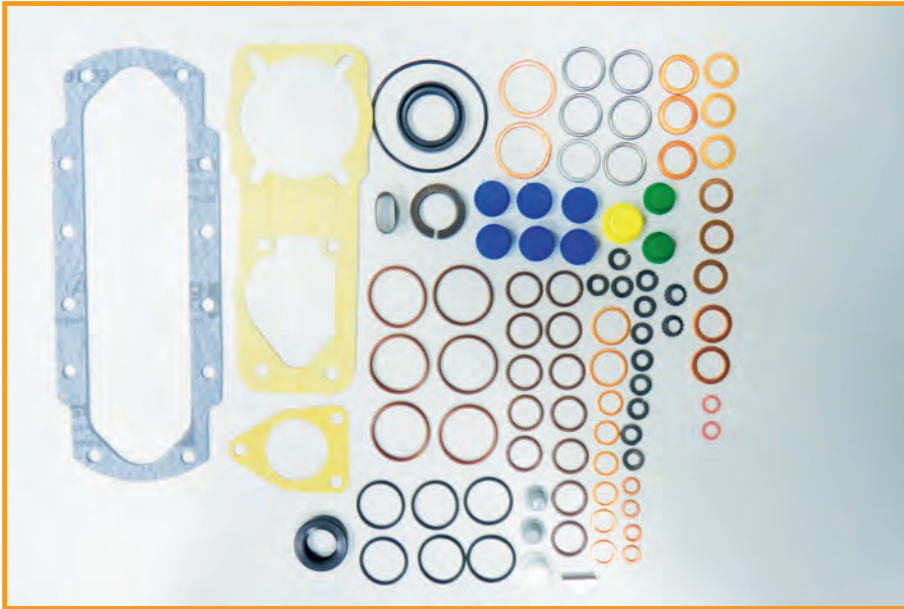

CODICE OMS 10-15-014/3

COD. Bh 2 417 010 001/G

COD.

COD.

COD.

TIPO-TYPE PE(S)..6P..

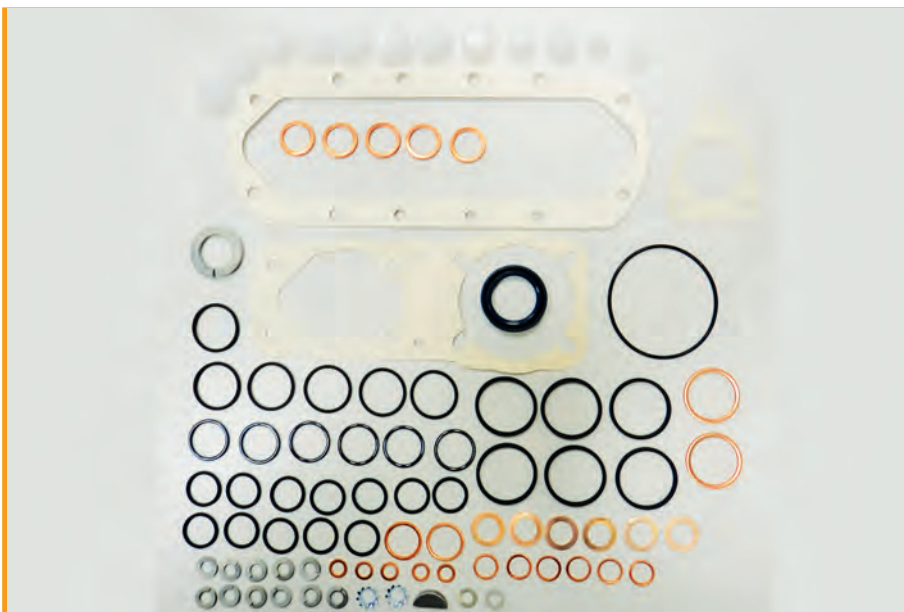

CODICE OMS 10-15-014/4

COD. Bh 2 417 010 001/H

COD.

COD.

COD.

10-15-014/5 A PAG. 93

TIPO-TYPE



CODICE OMS 10-15-015

COD. Bh 2 417 010 010

COD. Lucas 7135-379

COD.

COD.

TIPO-TYPE PE (S) 6P



CODICE OMS 10-15-016

COD. Bh 2 417 010 003

COD. Lucas 7135-375

COD.

COD.

10-15-016/1 PAG. 84

TIPO-TYPE PE (S) 8P

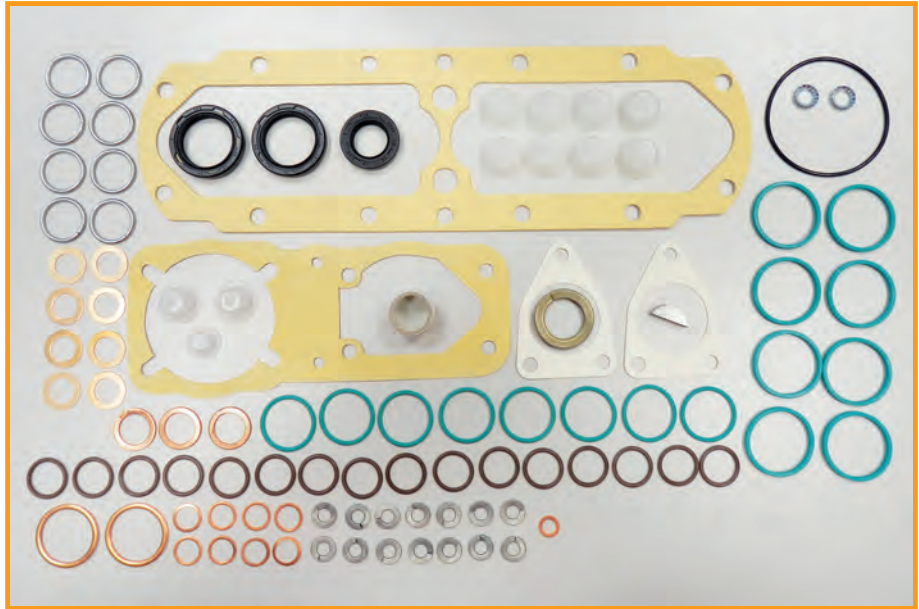

CODICE OMS 10-15-017

COD. Bh 1 417 010 002

COD. Lucas 7135-163

COD.

COD.

TIPO-TYPE PE 4P

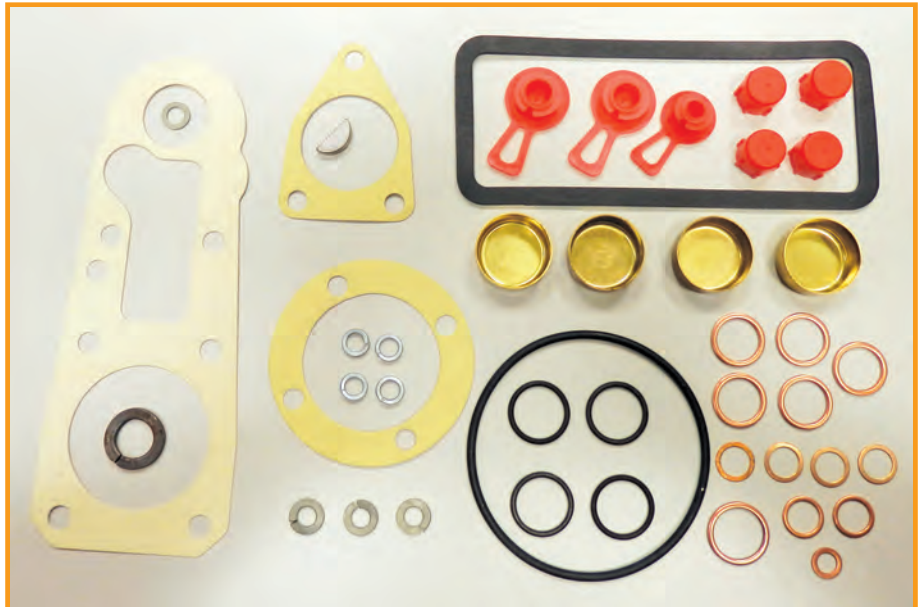

CODICE OMS 10-15-018

COD. Bh 1 417 010 003

COD. Lucas 7135-164

COD.

COD.

TIPO-TYPE PE 6P

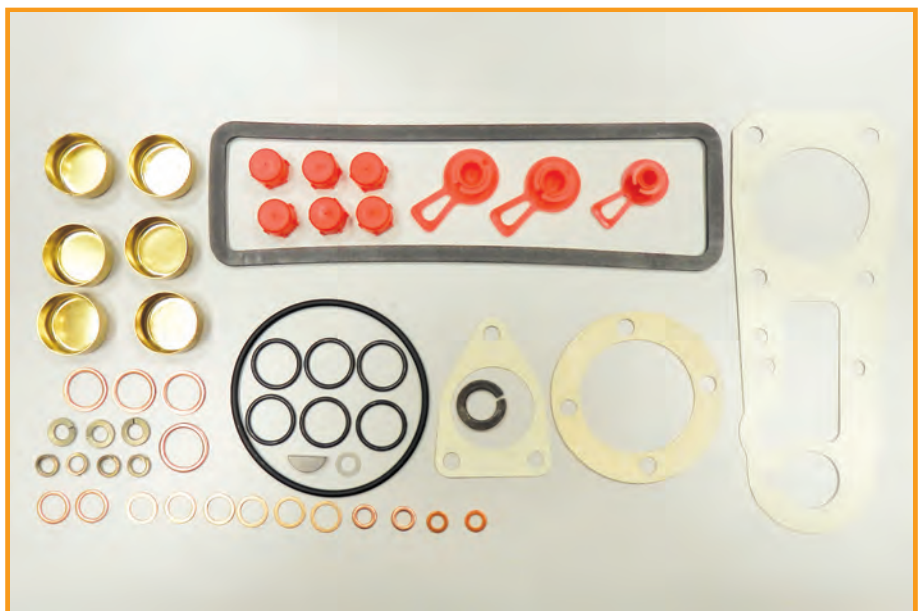

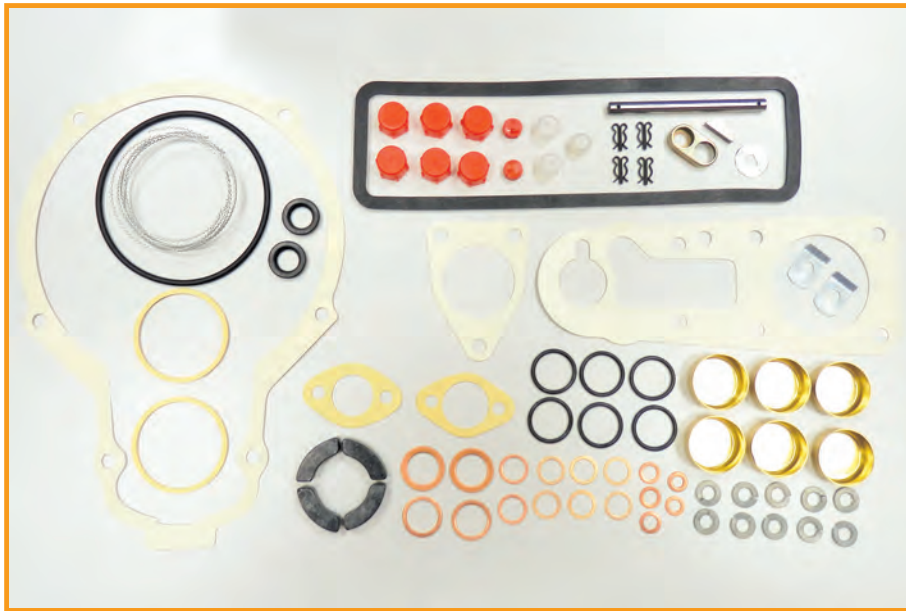

CODICE OMS 10-15-018/1

COD. Bh 1 417 010 003

COD. Lucas 7135-164

COD.

COD.

TIPO-TYPE PE 6P



CODICE OMS 10-15-019

COD. Bh 1 417 010 010

COD. Lucas 7135-371

COD.

COD.

TIPO-TYPE PE 6P



CODICE OMS 10-15-020

COD. Bh 2 417 010 005

COD.

COD.

COD.

TIPO-TYPE PE 8P



CODICE OMS 10-15-021

COD. Bh 2 417 010 008

COD. Lucas 7135-377

COD.

COD.

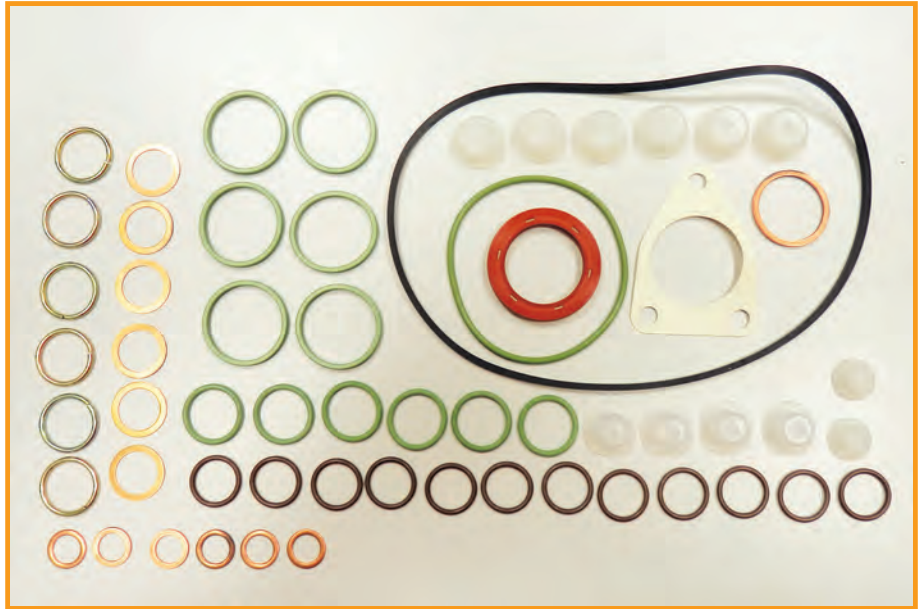

TIPO-TYPE PE 6P

CODICE OMS 10-15-022

COD. Bh 9 401 087 522

COD.

COD.

COD.



TIPO-TYPE PE 6P

CODICE OMS 10-15-022/1

COD. Bh 9 401 087 522

COD.

COD.

COD.



TIPO-TYPE PE 6P



CODICE OMS 10-15-023

COD. Bh 2 417 010 011

COD. Lucas 7135-380

COD.

COD.

TIPO-TYPE PE 6P

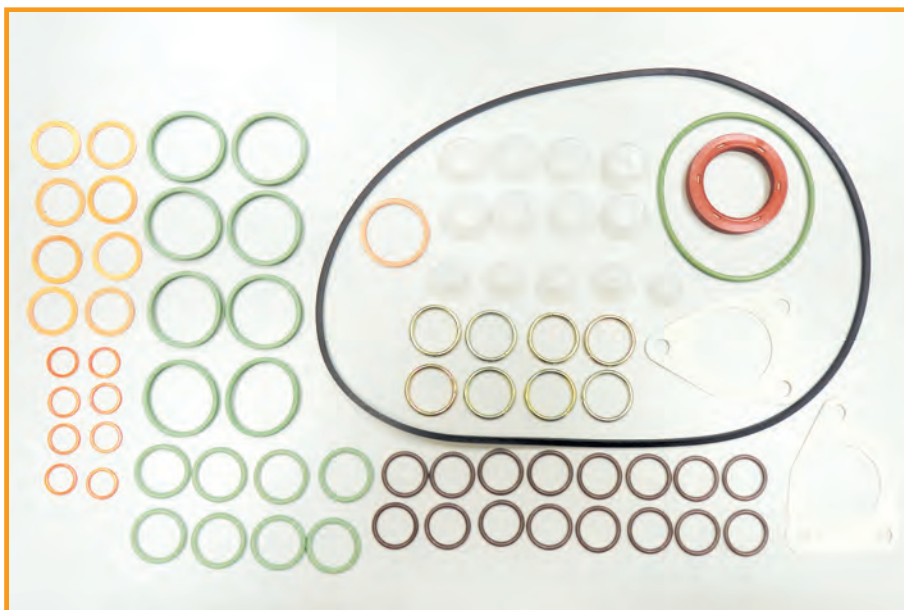

CODICE OMS 10-15-024

COD. Bh 2 417 010 009

COD. Lucas 7135-378

COD.

COD.

TIPO-TYPE PE 8P

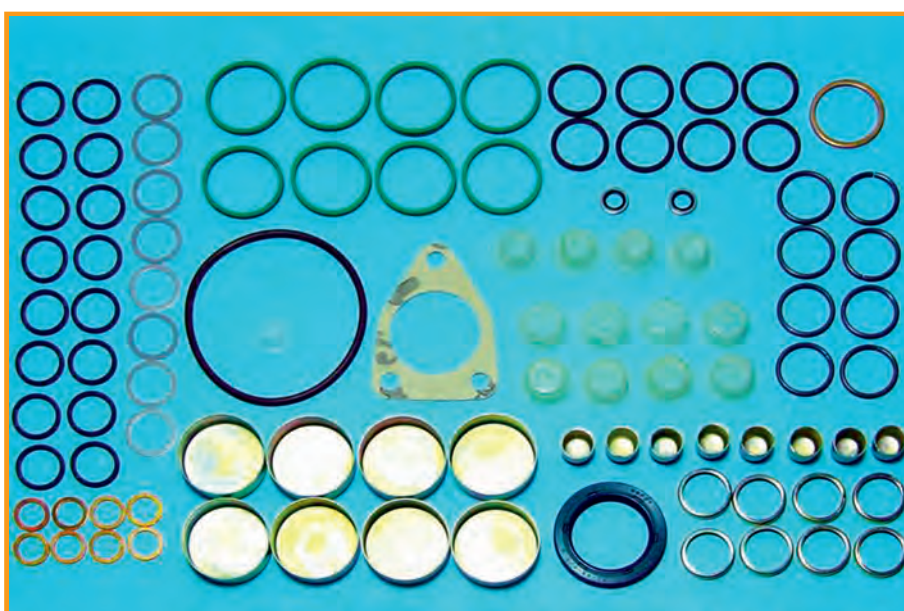

CODICE OMS 10-15-024/1

COD. Bh 2 417 010 009

COD. Lucas 7135-378

COD.

COD.

TIPO-TYPE PE 8P



CODICE OMS 10-15-025

COD. Bh 2 417 010 022

COD. Lucas 7135-383

COD.

COD.



TIPO-TYPE PE 8P

CODICE OMS 10-15-026

COD. Bh 2 417 010 004

COD. Lucas 7135-376

COD.

COD.

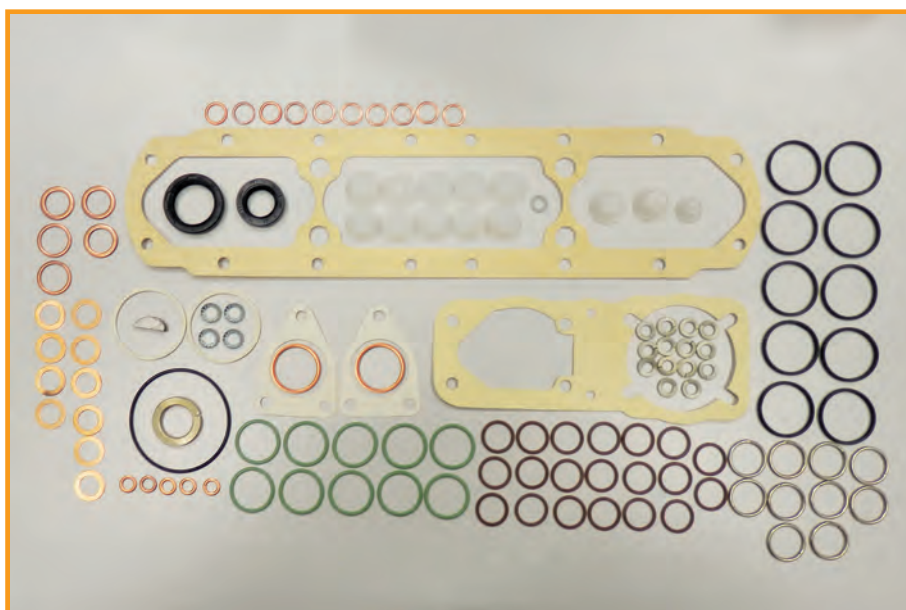

TIPO-TYPE PE 10P

CODICE OMS 10-15-027

COD. Bh 2 417 010 021

COD. Lucas 7135-382

COD.

COD.



TIPO-TYPE PE 6P

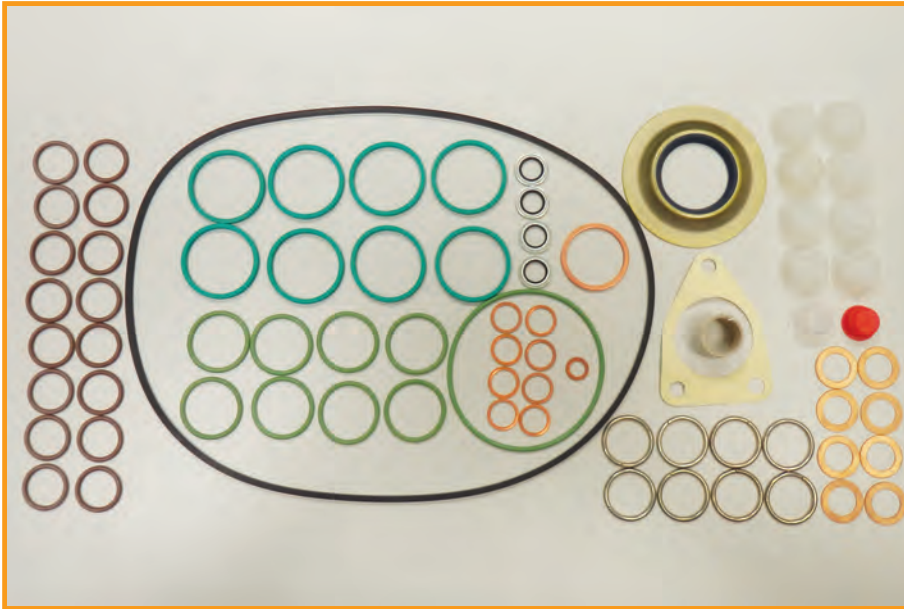

CODICE OMS 10-15-028

COD. Bh 2 417 010 028

COD. Mercedes

COD.

COD.

TIPO-TYPE PE 8P

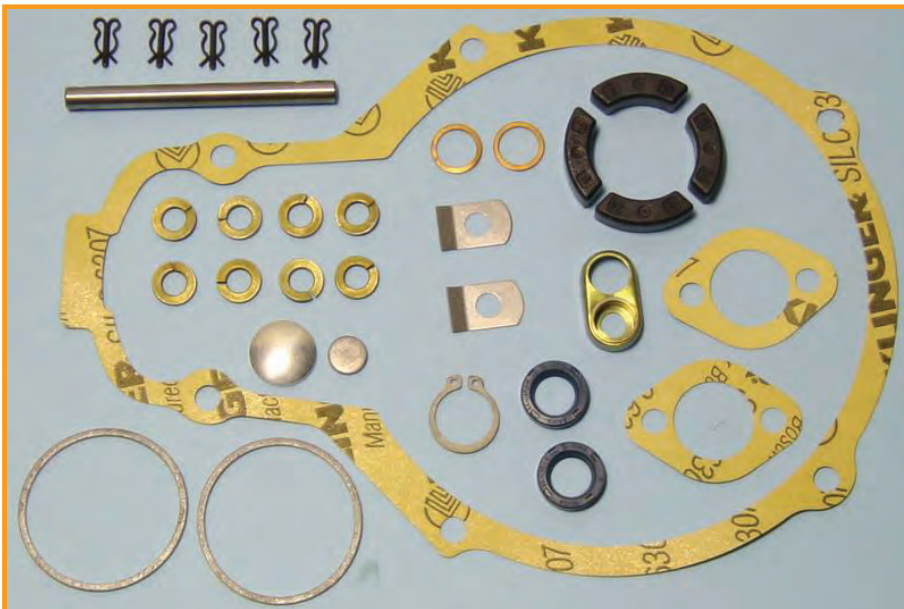

CODICE OMS 10-15-029

COD. Bh 1 427 010 002

COD. Lucas 7135-166

COD.

COD.

TIPO-TYPE RQ-V

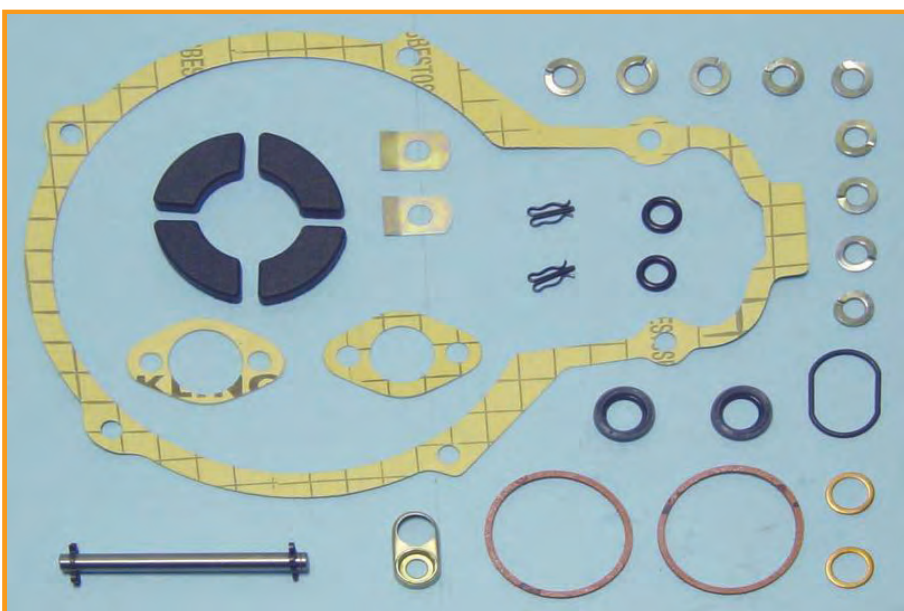

CODICE OMS 10-15-029/1

COD. Bh 1 427 010 002/1

COD.

COD.

COD.

TIPO-TYPE RQ-V



CODICE OMS 10-15-030

COD. Bh 1 417 010 007

COD.

COD.

COD.



TIPO-TYPE PES 8..MW..100/720 RS..

CODICE OMS 10-15-031

COD. Bh 1 427 010 003

COD. Lucas 7135-172

COD.

COD.

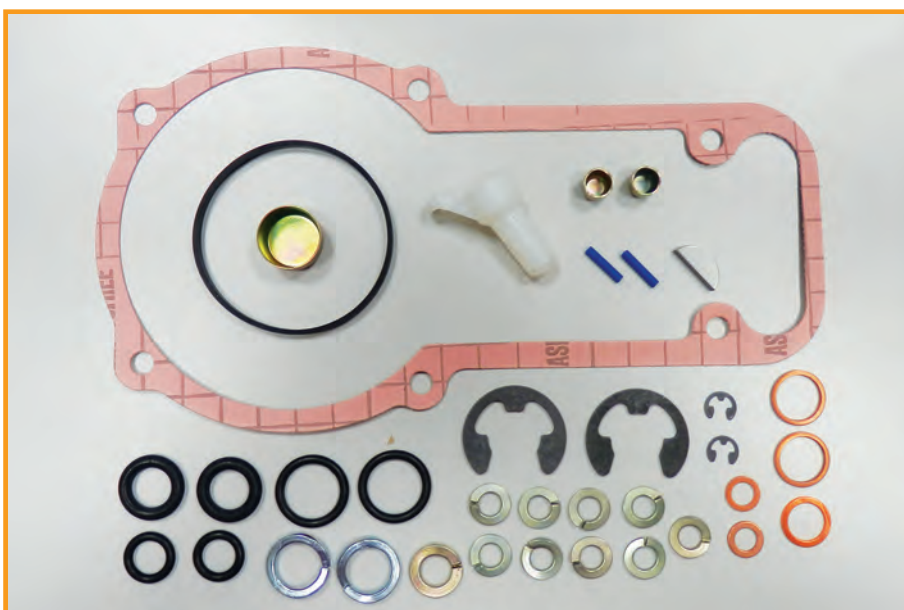

TIPO-TYPE RSV

CODICE OMS 10-15-032

COD. Bh 2 467 010 003

COD. Lucas 7135-396

COD.

COD.



TIPO-TYPE EDC

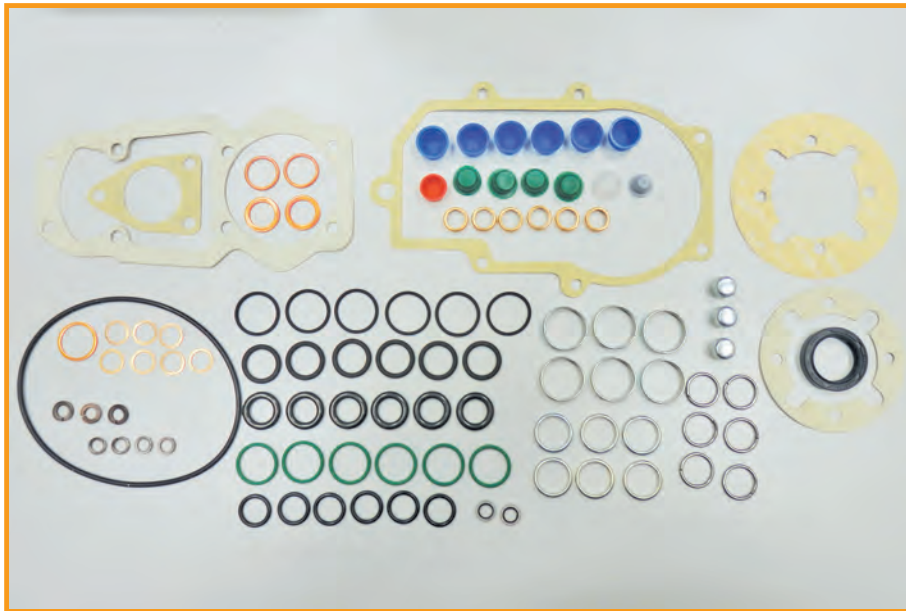

CODICE OMS 10-15-033

COD. Bh 1 417 010 008

COD. Lucas 7135-374

COD.

COD.

TIPO-TYPE PES 6P..MW

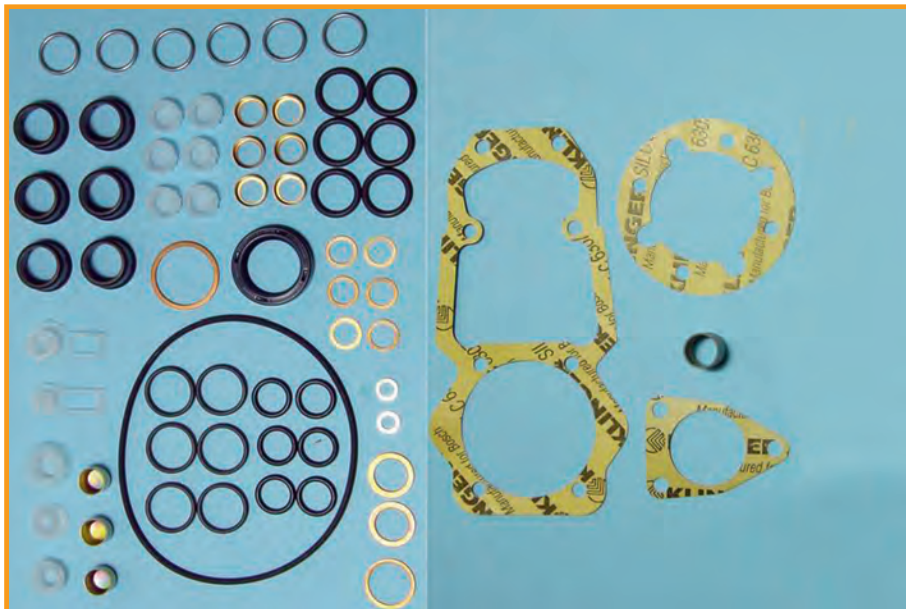

CODICE OMS 10-15-033/1

COD. Bh 1 417 010 008

COD.

COD.

COD.

TIPO-TYPE PE 6P MW

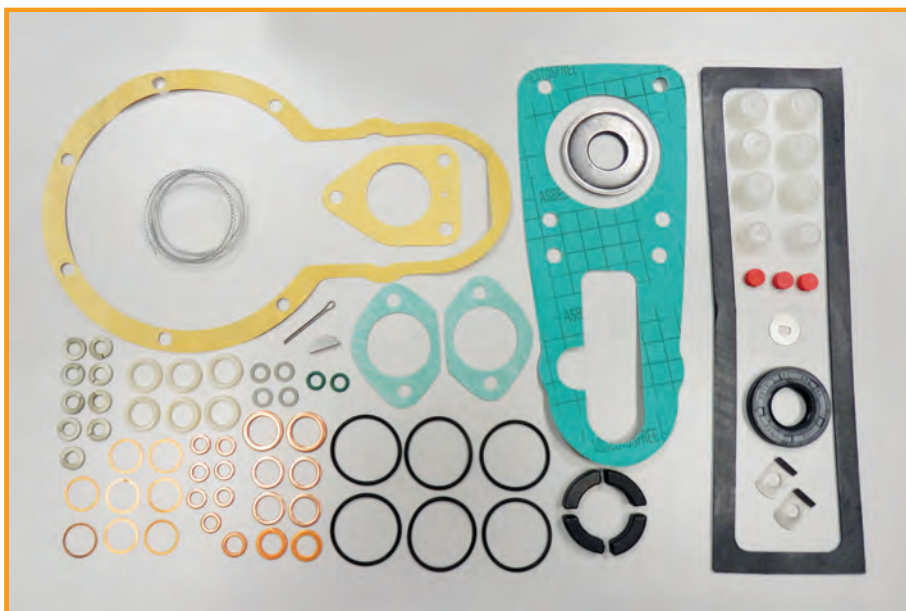

CODICE OMS 10-15-034

COD. Iveco 682-N3

COD.

COD.

COD.

TIPO-TYPE PE..6B RPB/RPVB



CODICE OMS 10-15-034/1

COD. Iveco 693-N7

COD.

COD.

COD.

TIPO-TYPE PE..6BV

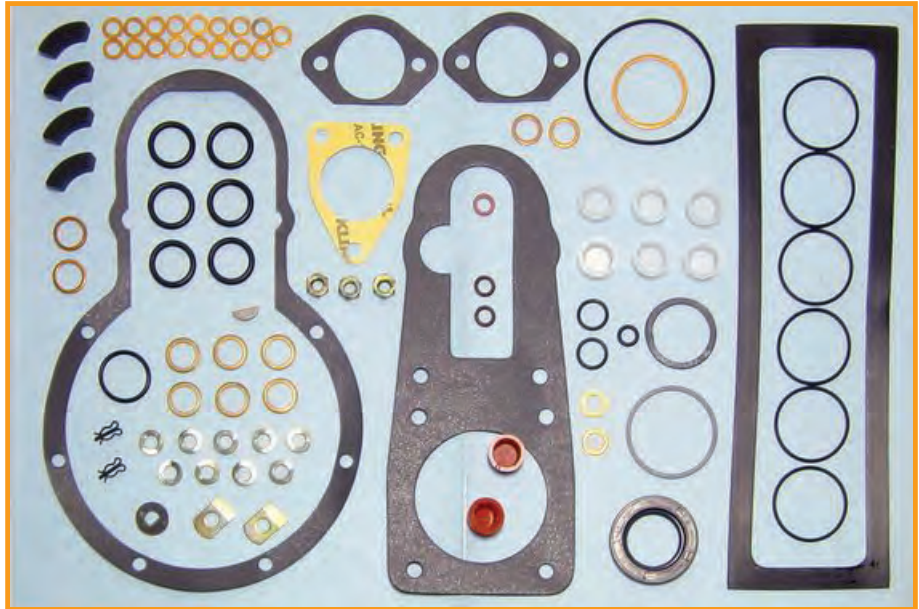

CODICE OMS 10-15-034/2

COD. GK 301

COD.

COD.

COD.

TIPO-TYPE PE..6B..E

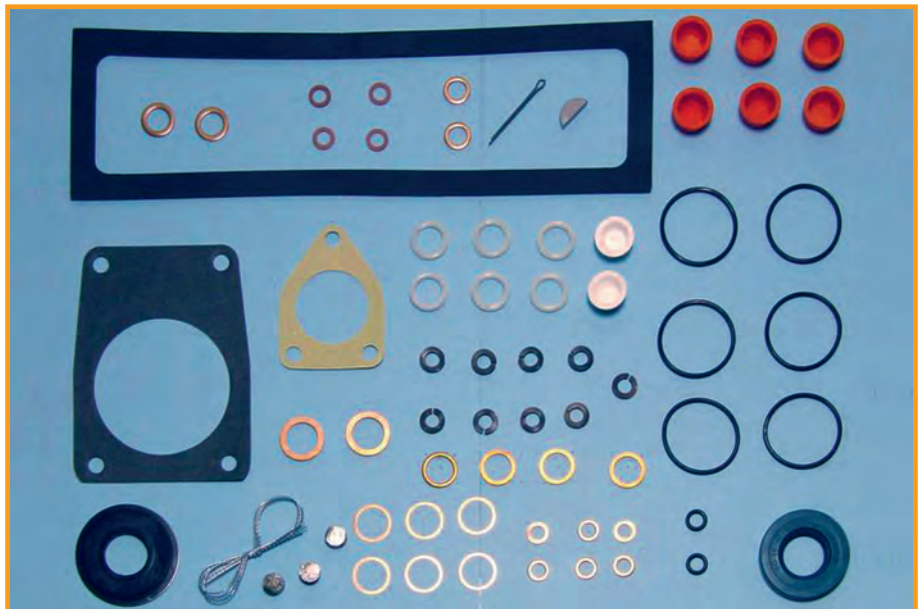

CODICE OMS 10-15-034/3

COD. Iveco

COD.

COD.

COD.

TIPO-TYPE PE..6B

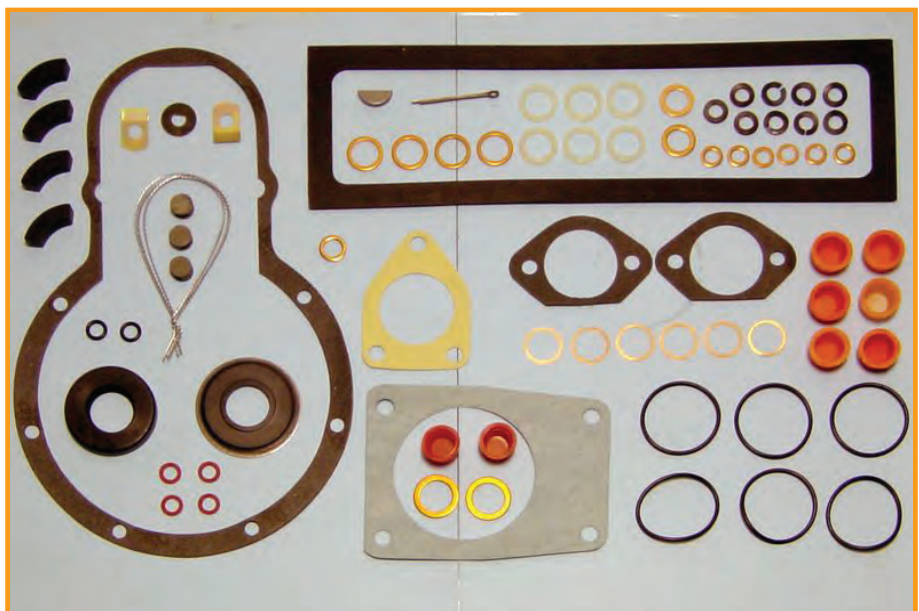

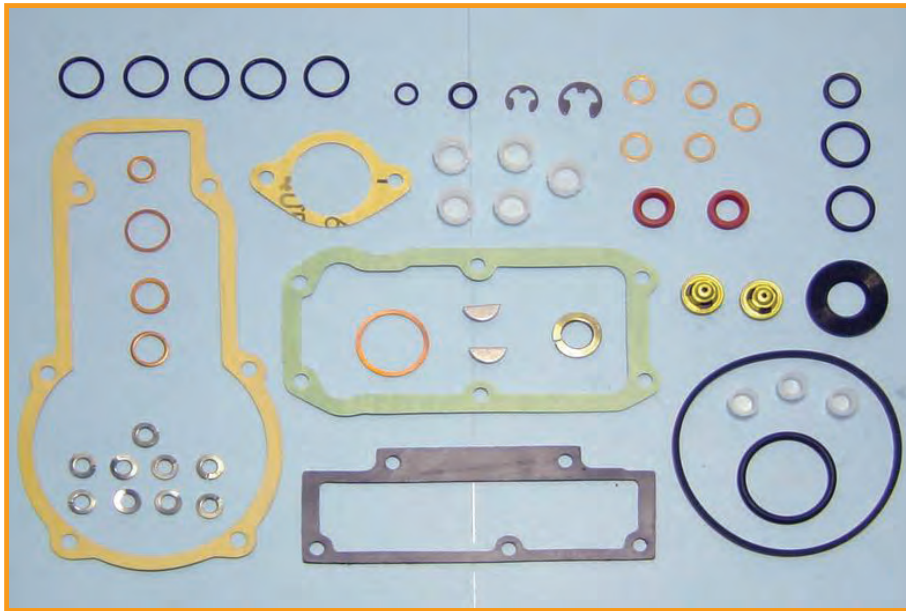

CODICE OMS 10-15-036

COD. Mercedes 250D

COD.

COD.

COD.

5 cilindri + regolatore RSF

TIPO-TYPE PE..6BV



CODICE OMS 10-15-037

COD. Bh 1 417 010 009

COD.

COD.

COD.

TIPO-TYPE PE 8..MW

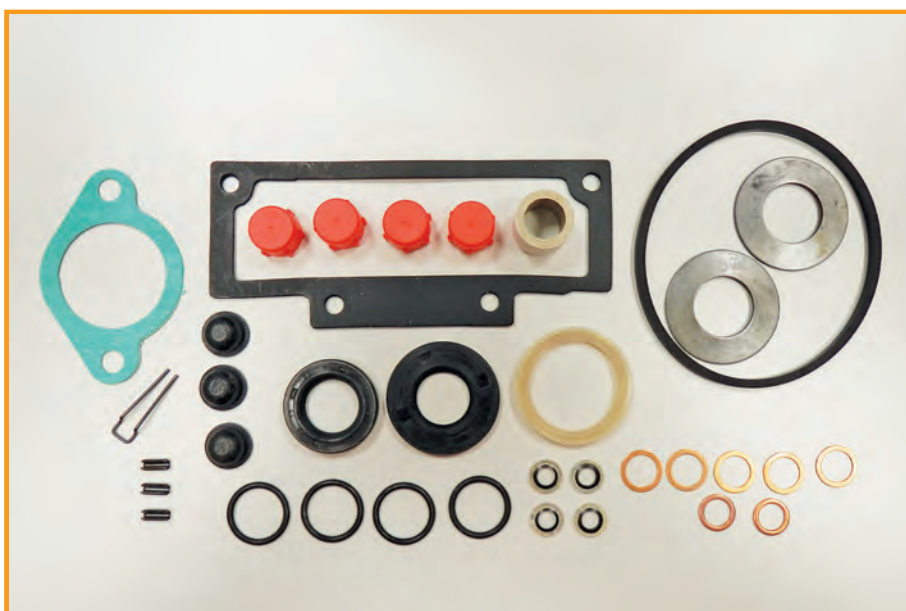

CODICE OMS 10-15-038

COD. Bh 1 417 010 011

COD. Mercedes 190D

COD.

COD.

TIPO-TYPE PES 4M



CODICE OMS 10-15-039

COD. Bh 1 467 010 007

COD.

COD.

COD.

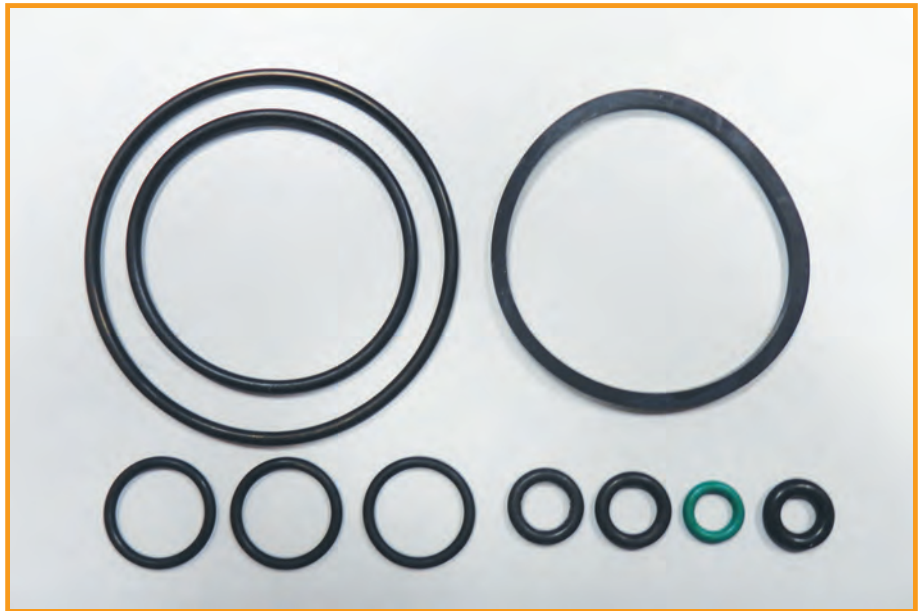

TIPO-TYPE EP-VA

CODICE OMS 10-15-040

COD. Bh 1 467 010 008

COD. Denso 190440-0420

COD.

COD.



TIPO-TYPE EP-VA PE 6P

CODICE OMS 10-15-041

COD. Bh 1 467 010 016

COD.

COD.

COD.

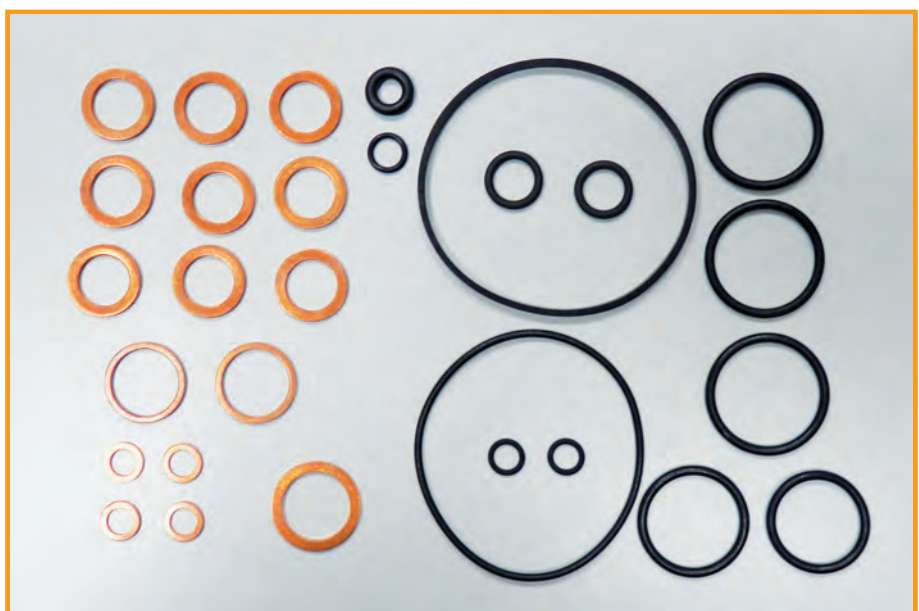

TIPO-TYPE VM

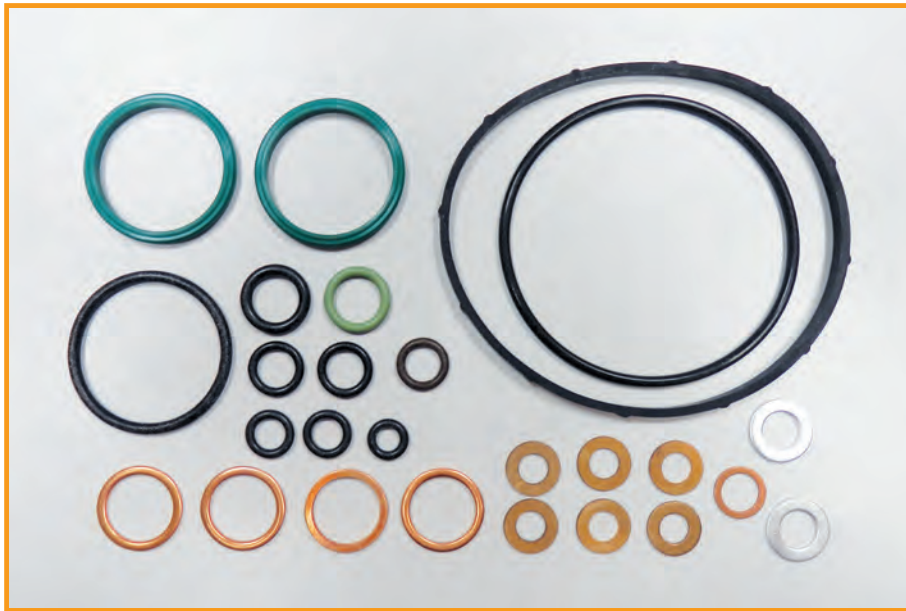

CODICE OMS 10-15-043

COD. Bh 1 467 010 316

COD. _____

COD. _____

COD. _____

TIPO-TYPE EP-VE



CODICE OMS 10-15-043/1

COD. Bh 1 467 010 316

COD. _____

COD. _____

COD. _____

TIPO-TYPE EP-VE



CODICE OMS 10-15-044

COD. Bh 2 417 010 020

COD. _____

COD. _____

COD. _____

TIPO-TYPE PE 6P



CODICE OMS 10-15-045

COD. Bh 9 401 081 131

COD.

COD.

COD.

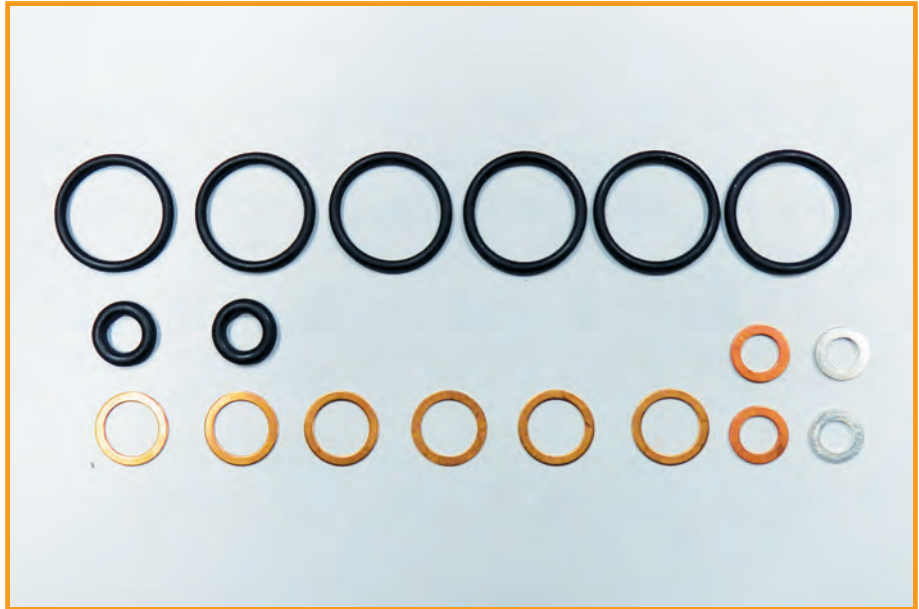

TIPO-TYPE PE 6A

CODICE OMS 10-15-046

COD. Bh 9 401 083 072

COD.

COD.

COD.



TIPO-TYPE PE 6A

CODICE OMS 10-15-047

COD. Bh 9 401 087 009

COD.

COD.

COD.

10-15-047/1 PAG. 84



TIPO-TYPE PE 6P S3000



CODICE OMS 10-15-048

COD. Bh 9 401 087 173

COD. _____

COD. _____

COD. _____

TIPO-TYPE PE 6P S7000



CODICE OMS 10-15-048/1

COD. Bh 9 401 087 173

COD. _____

COD. _____

COD. _____

Versione Brasile

TIPO-TYPE PE6P S7000



CODICE OMS 10-15-050

COD. Bh 9 421 080 220

COD. _____

COD. _____

COD. _____

TIPO-TYPE EP-RSV



CODICE OMS 10-15-051

COD. DGK 103

COD. Lucas 7135-415

COD.

COD.

TIPO-TYPE PES 8A

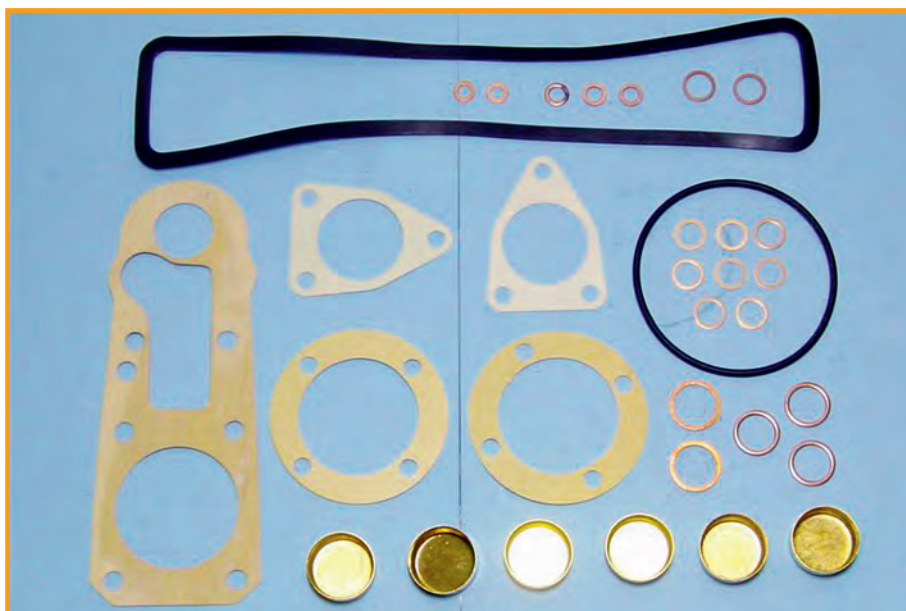

CODICE OMS 10-15-052

COD. DGK 104

COD. Lucas 7135-416

COD.

COD.

TIPO-TYPE PES 6PA

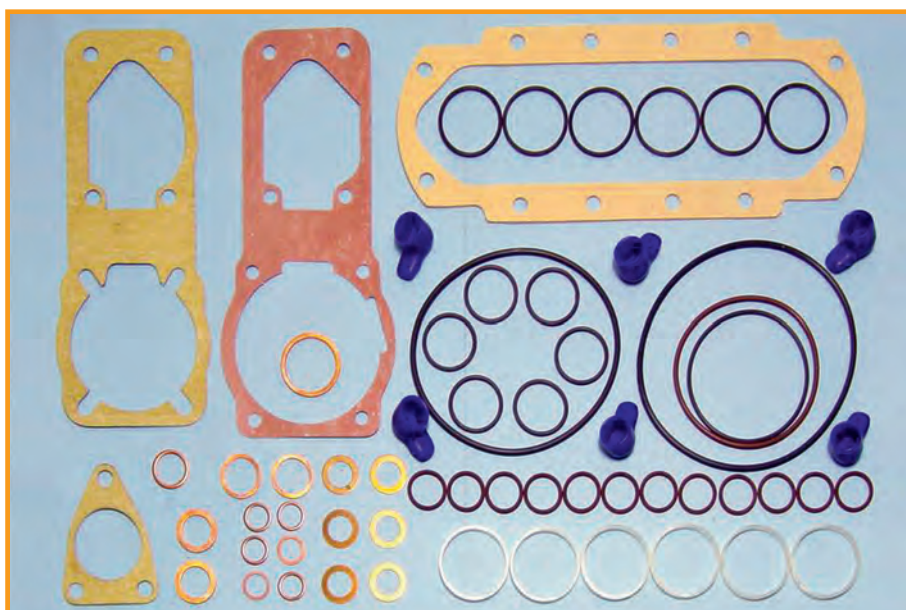

CODICE OMS 10-15-053

COD. DGK 105

COD. Lucas 7135-417

COD.

COD.

TIPO-TYPE PES 6A

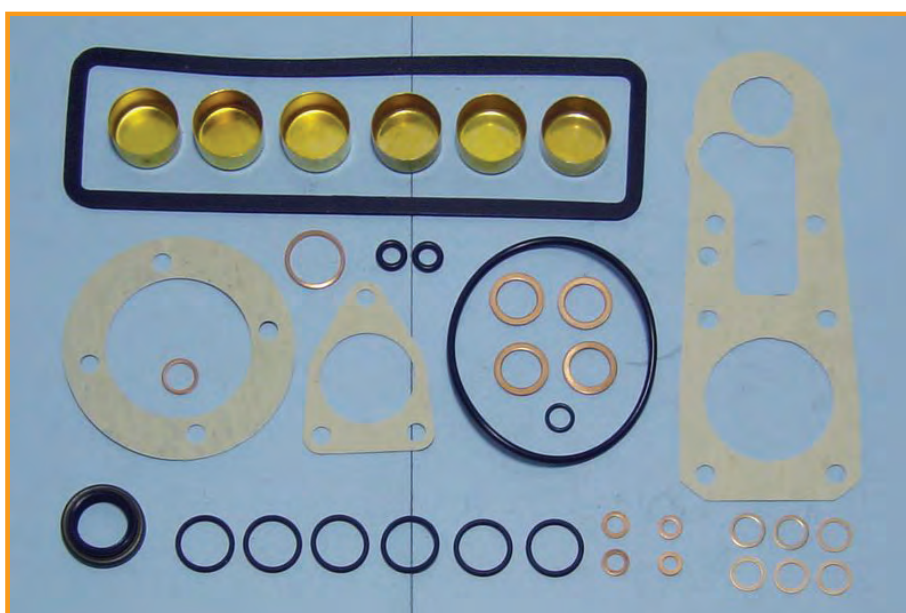

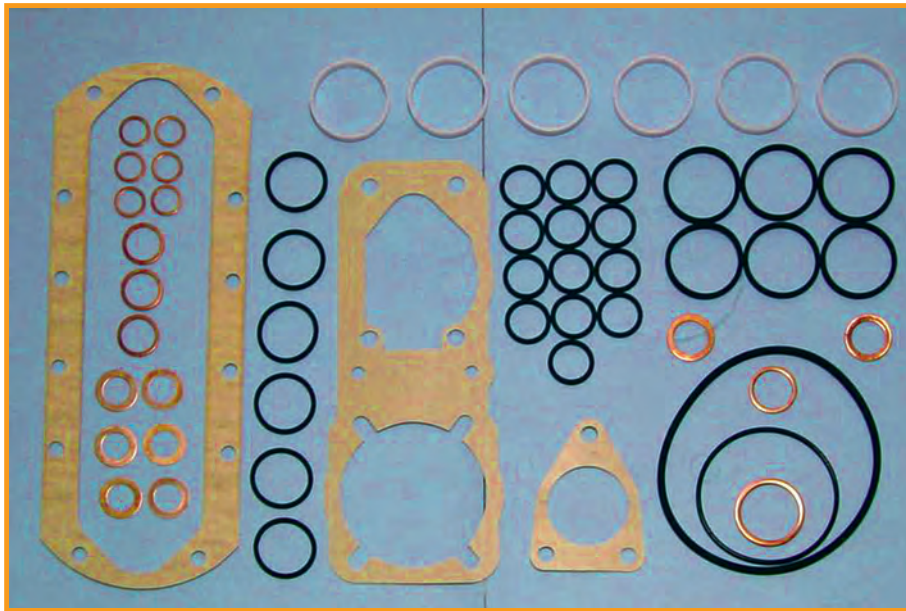

CODICE OMS 10-15-054

COD. DGK 106

COD. Lucas 7135-201

COD.

COD.

TIPO-TYPE PES 6P

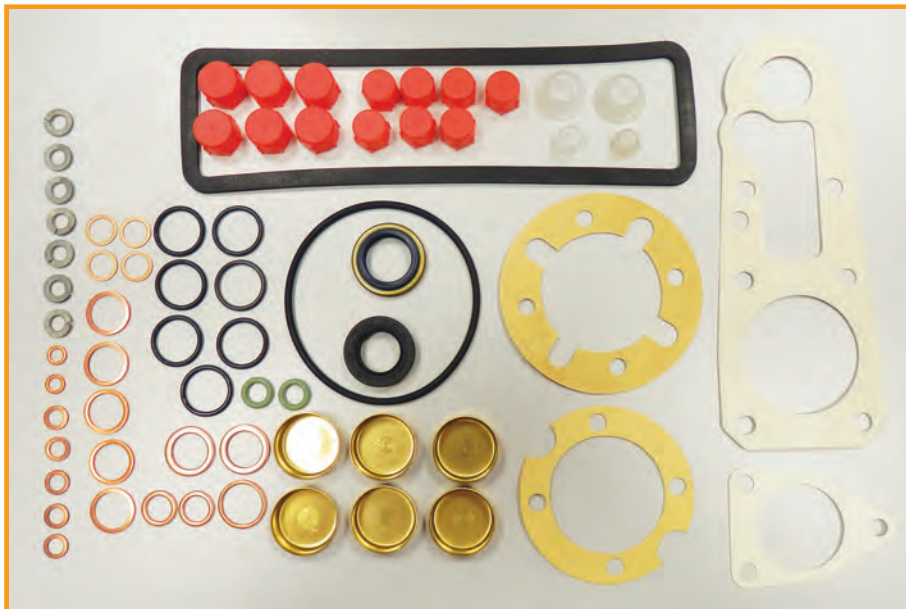

CODICE OMS 10-15-055

COD. DGK 107

COD. Lucas 7135-418

COD.

COD.

TIPO-TYPE PES 6A



CODICE OMS 10-15-056

COD. DGK 108

COD.

COD.

COD.

TIPO-TYPE PES 4A



CODICE OMS 10-15-057

COD. DGK 109

COD.

COD.

COD.

TIPO-TYPE PES 6..MW

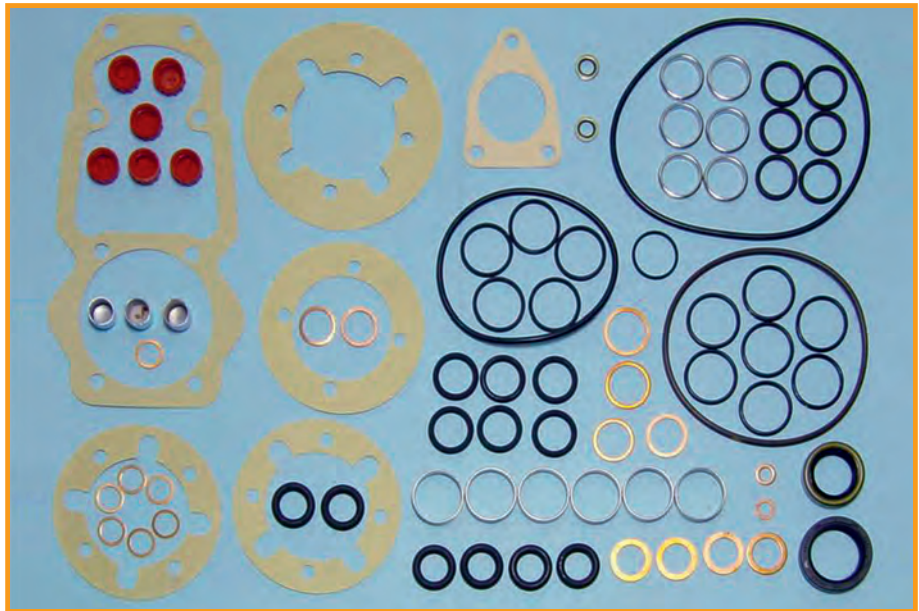

CODICE OMS 10-15-058

COD. DGK 110

COD.

COD.

COD.

TIPO-TYPE PE 6P

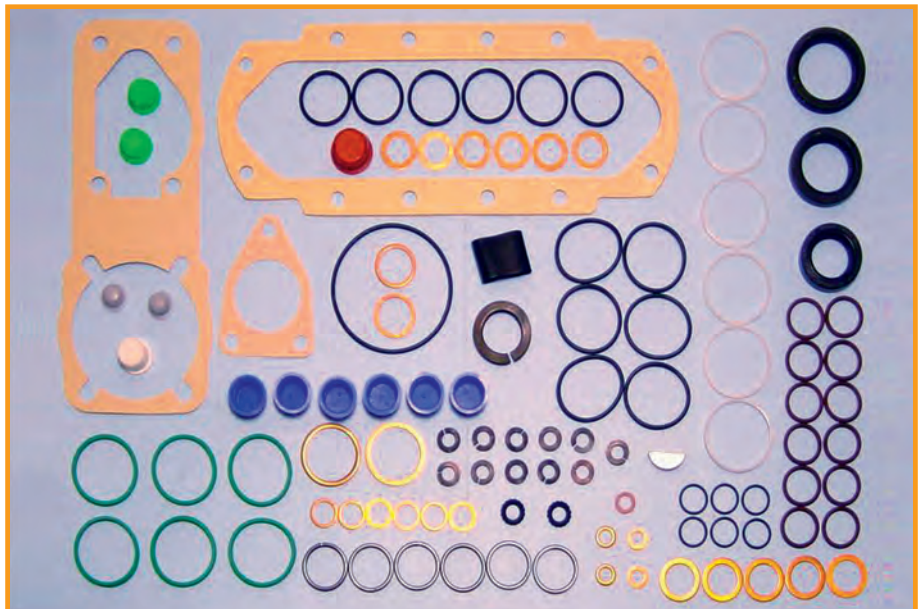

CODICE OMS 10-15-059

COD. DGK 111

COD. Lucas 7135-419

COD. Lucas 7135-192

COD.

TIPO-TYPE PES 6P MACK

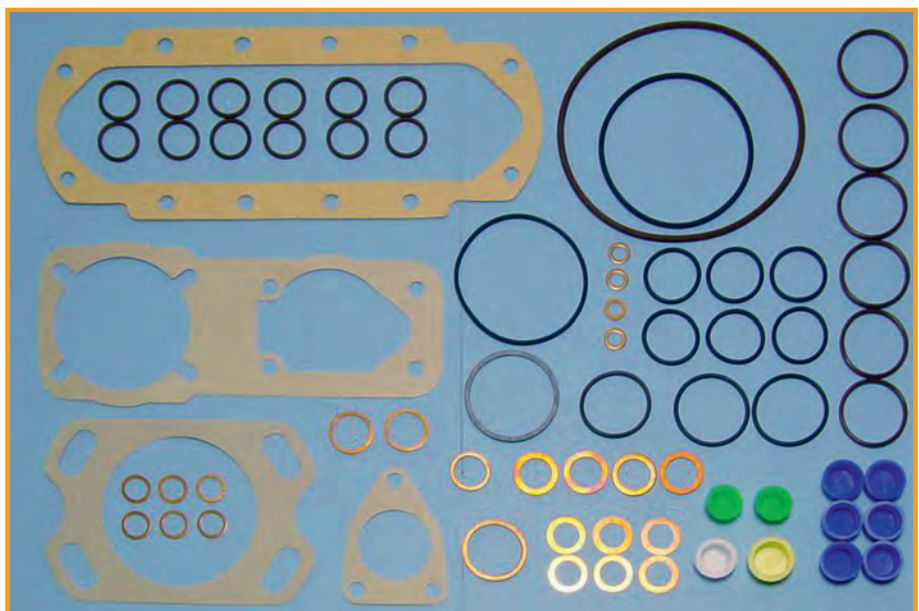



CODICE OMS 10-15-060

COD. DGK 112

COD.

COD.

COD.

TIPO-TYPE PES 4A

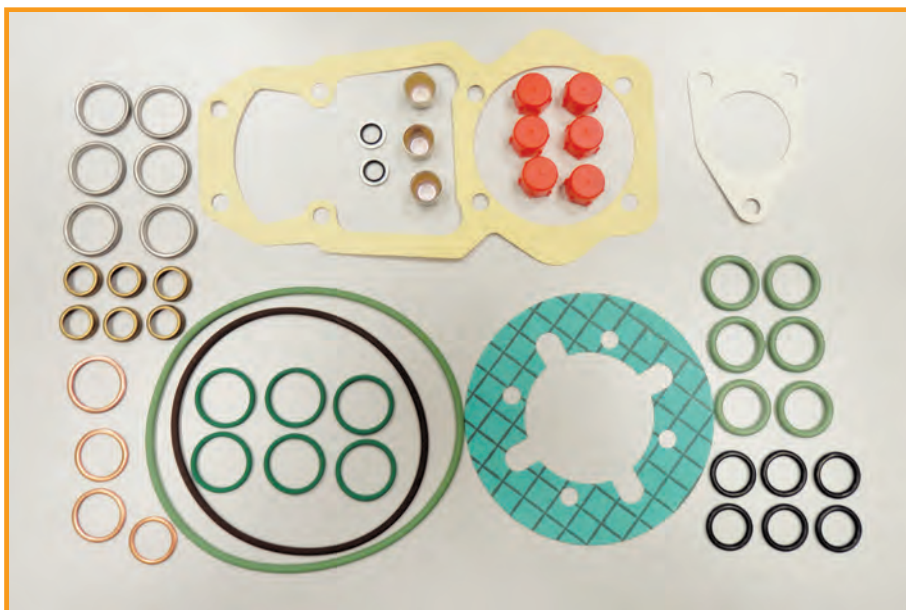

CODICE OMS 10-15-061

COD. DGK 115

COD. Lucas 7135-420

COD. Lucas 7135-193

COD.

TIPO-TYPE PES 6..MW

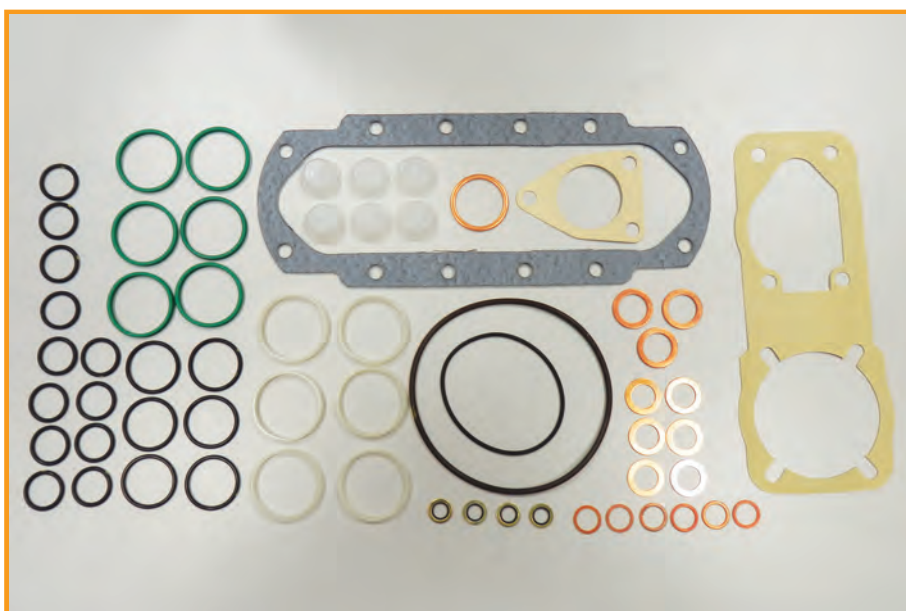

CODICE OMS 10-15-062

COD. DGK 116

COD. Lucas 7135-421

COD. Lucas 7135-194

COD.

TIPO-TYPE PES 6P 3000



CODICE OMS 10-15-063

COD. DGK 118

COD.

COD.

COD.

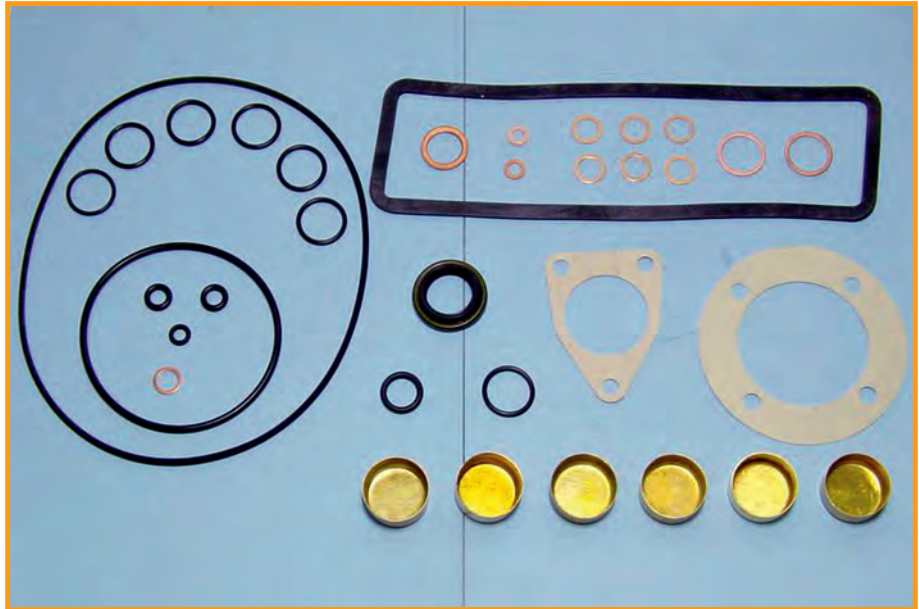

TIPO-TYPE PES 6A 2000 FORD

CODICE OMS 10-15-064

COD. DGK 119

COD. Lucas 7135-422

COD.

COD.

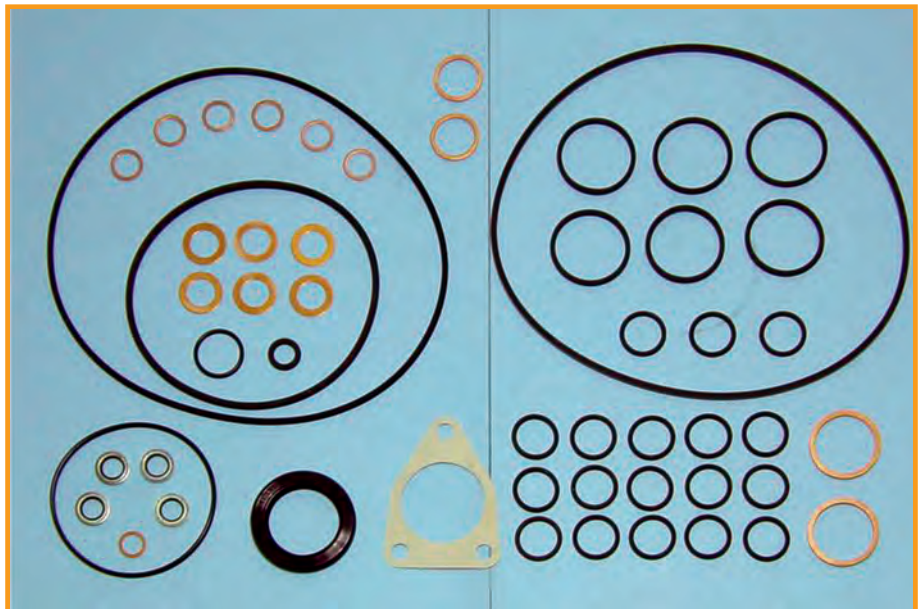

TIPO-TYPE PES 6P 3000 FORD

CODICE OMS 10-15-065

COD. DGK 120

COD. Lucas 7135-423

COD.

COD.



TIPO-TYPE PES 6P MACK



CODICE OMS 10-15-066

COD. DGK 122

COD.

COD.

COD.

DGK 133 pag. 91

TIPO-TYPE PES 6P RS8500 MACK

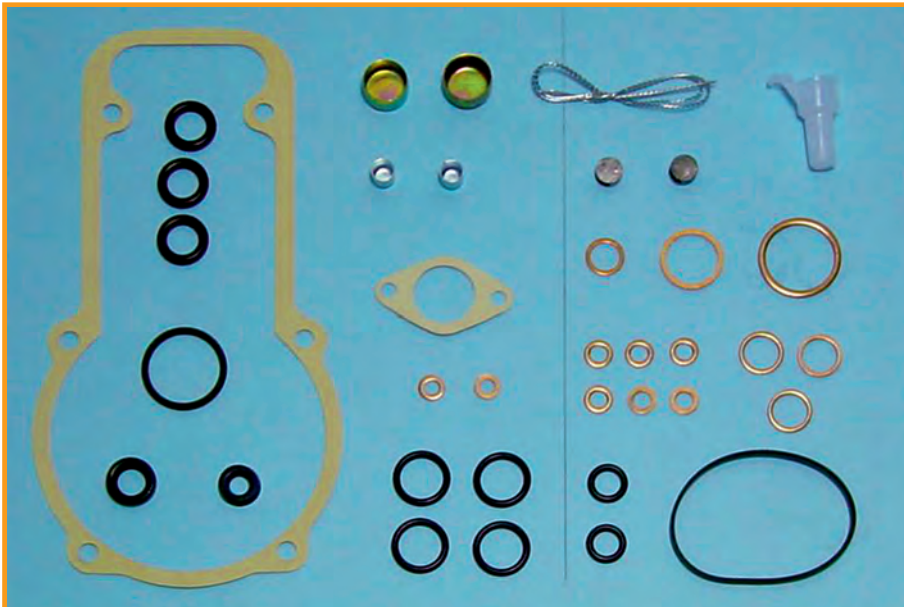

CODICE OMS 10-15-067

COD. DGK 201

COD. Lucas 7135-195

COD.

COD.

TIPO-TYPE RSV

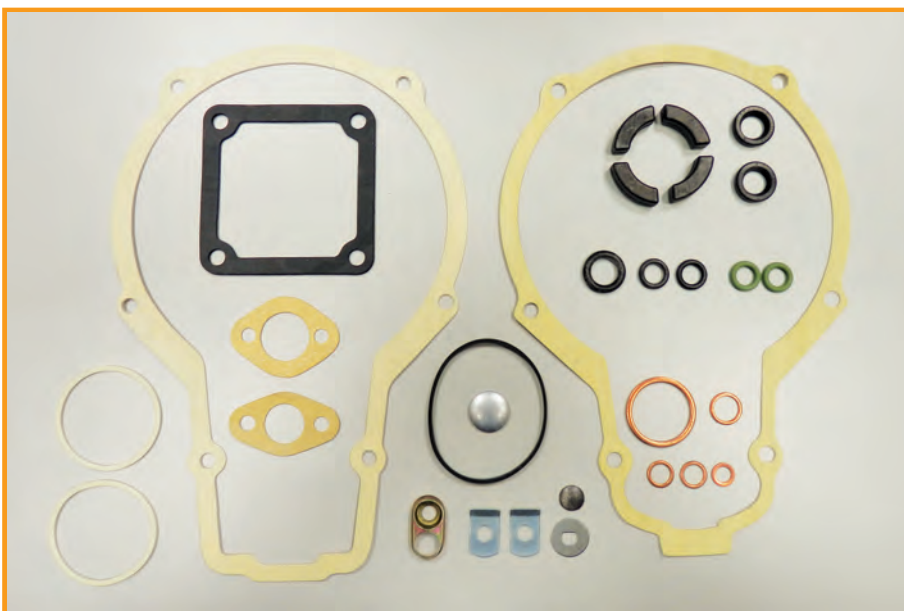

CODICE OMS 10-15-068

COD. DGK 202

COD. Lucas 7135-427

COD. Lucas 7135-196

COD.

TIPO-TYPE RQV



CODICE OMS 10-15-068/1

COD. DGK 202

COD. Lucas 7135-427

COD. Lucas 7135-196

COD.

TIPO-TYPE RQV tipo K

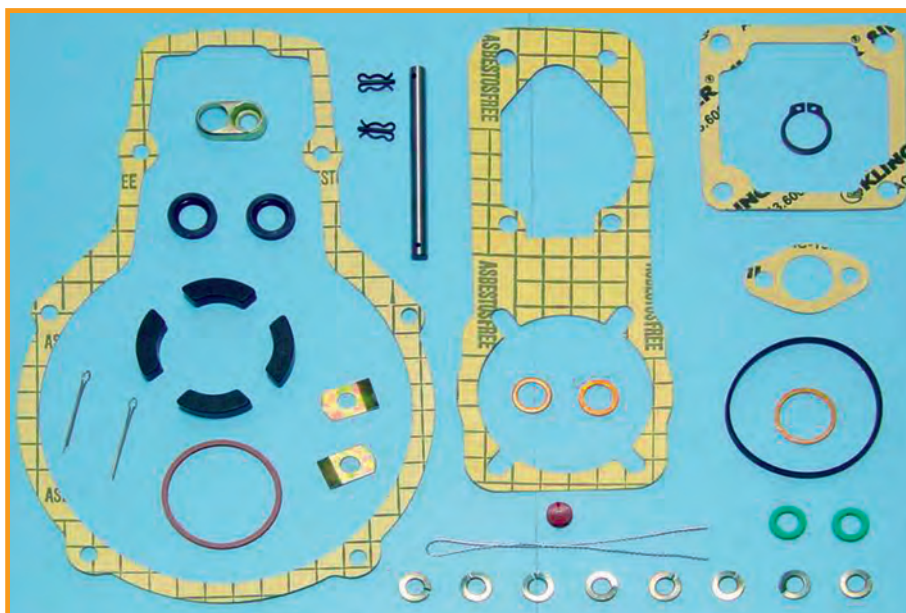

CODICE OMS 10-15-069

COD. DGK 203

COD. Lucas 7135-428

COD.

COD.

TIPO-TYPE RQV ..MW

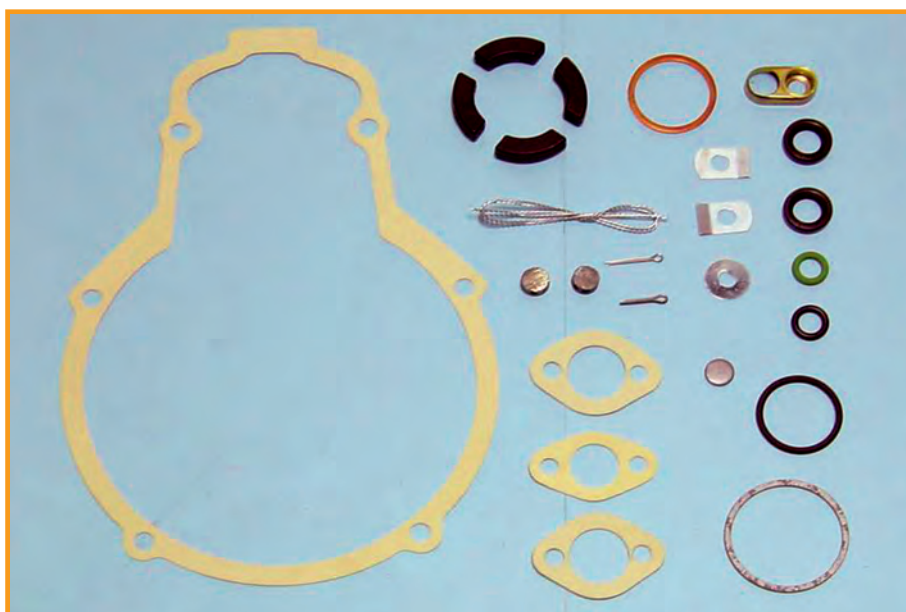

CODICE OMS 10-15-070

COD. DGK 204

COD. Lucas 7135-429

COD.

COD.

TIPO-TYPE RQV ..PA..K

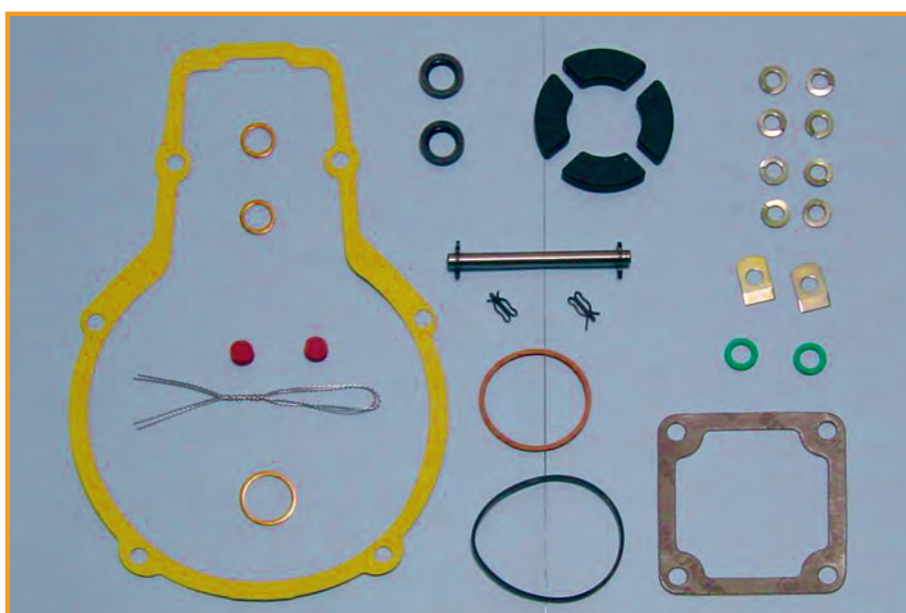

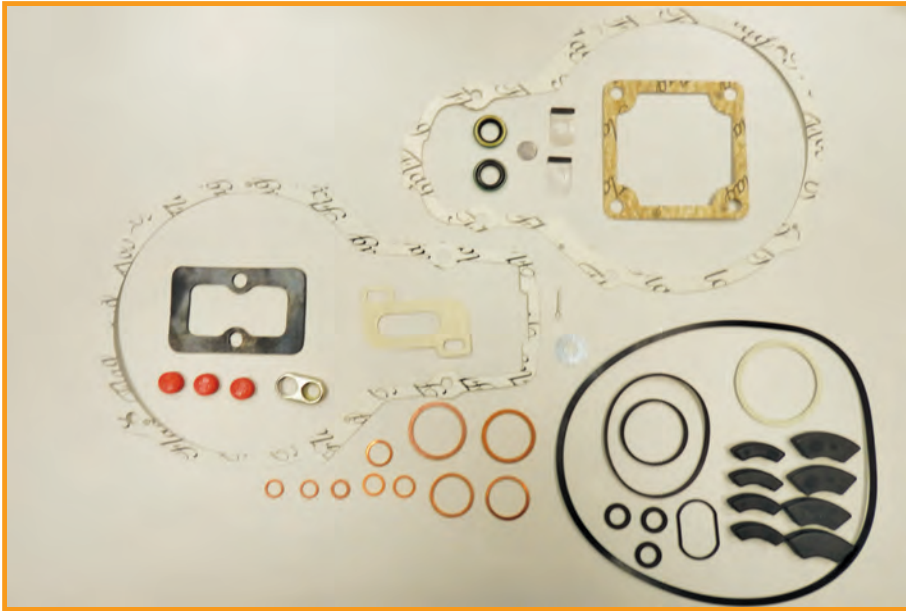

CODICE OMS 10-15-070/1	
COD.	DGK 204
COD.	
COD.	
COD.	
TIPO-TYPE	RQV-K

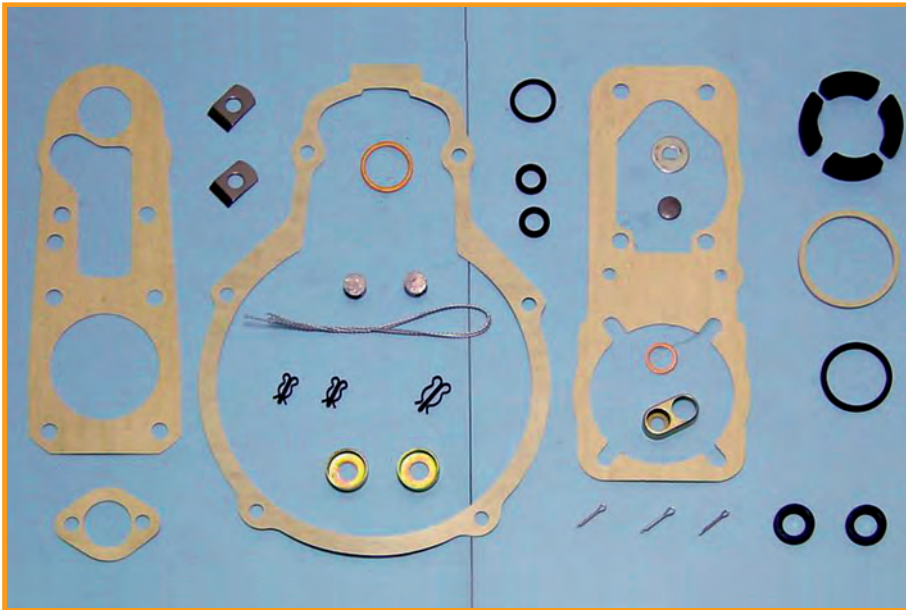

CODICE OMS 10-15-071	
COD.	DGK 205
COD.	Lucas 7135-430
COD.	
COD.	
TIPO-TYPE	RQV ..PA..AB

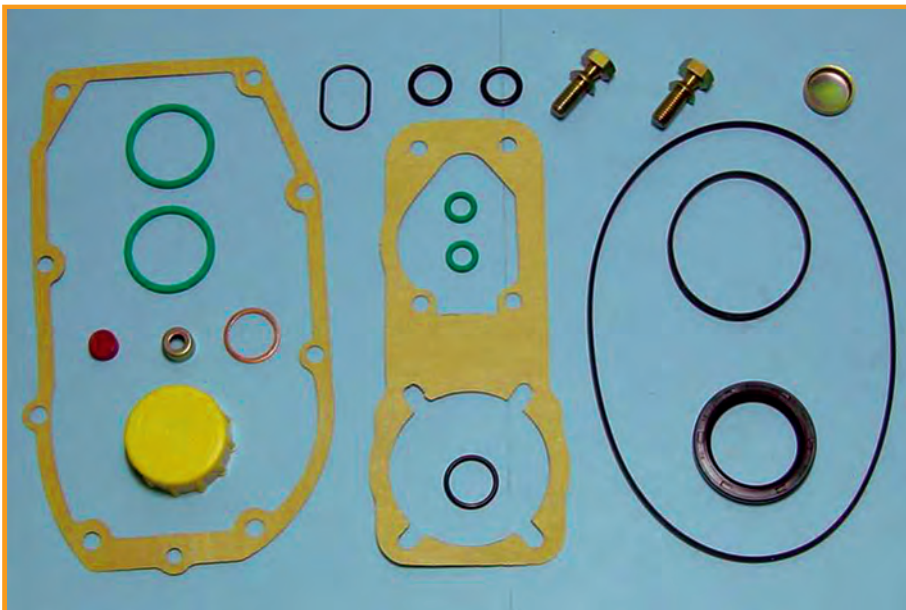

CODICE OMS 10-15-072	
COD.	DGK 206
COD.	
COD.	
COD.	
TIPO-TYPE	EDC MACK



CODICE OMS 10-15-072/2

COD. R/KIT GOVERNOR EDC

COD.

COD.

COD.

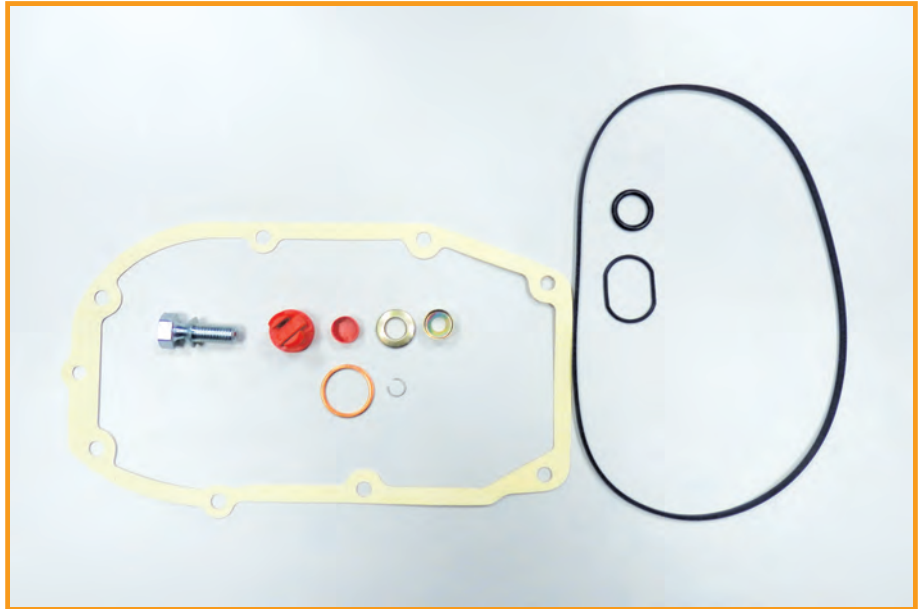

TIPO-TYPE RE30/CUMMINS

CODICE OMS 10-15-072/3

COD. R/KIT GOVERNOR EDC

COD.

COD.

COD.

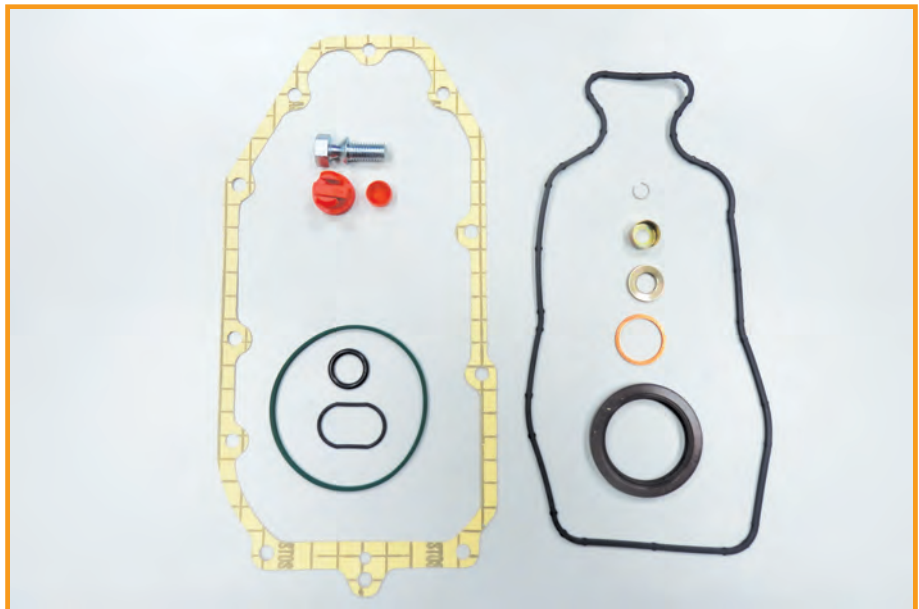

TIPO-TYPE RE31

CODICE OMS 10-15-073

COD. Denso 190440-0300

COD. Lucas 7135-401

COD.

COD.

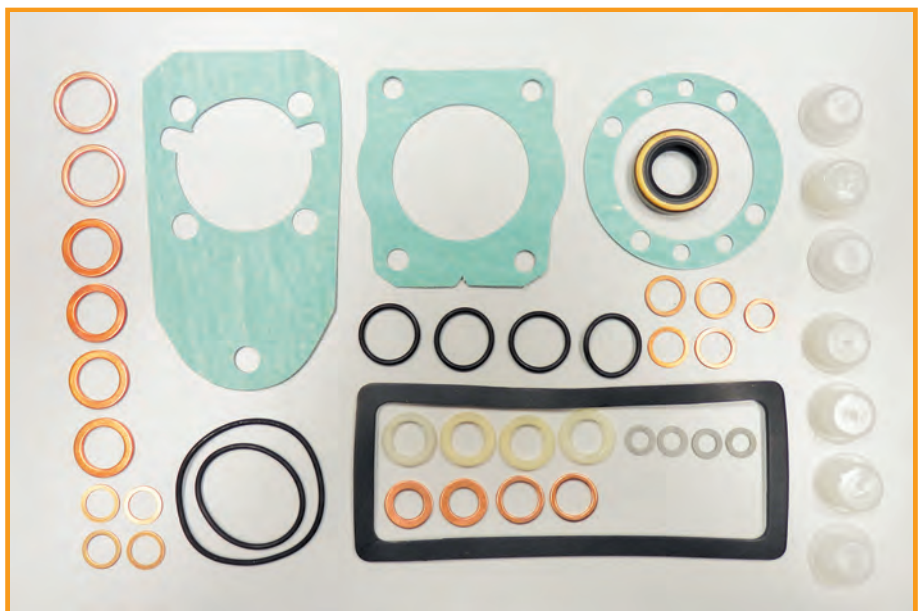

TIPO-TYPE PE 4A

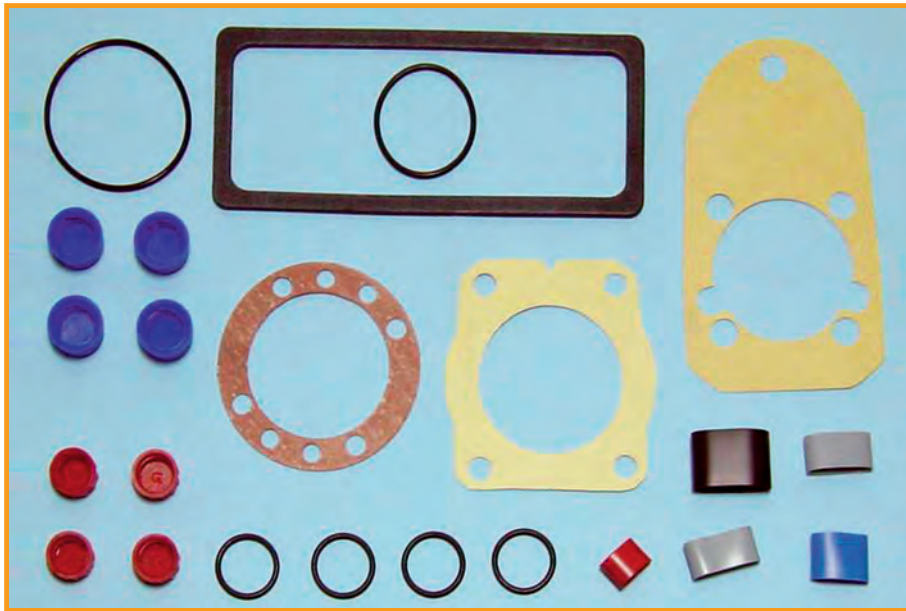

CODICE OMS 10-15-074

COD. Denso 190440-0310

COD. Lucas 7135-402

COD.

COD.

TIPO-TYPE PE 4A

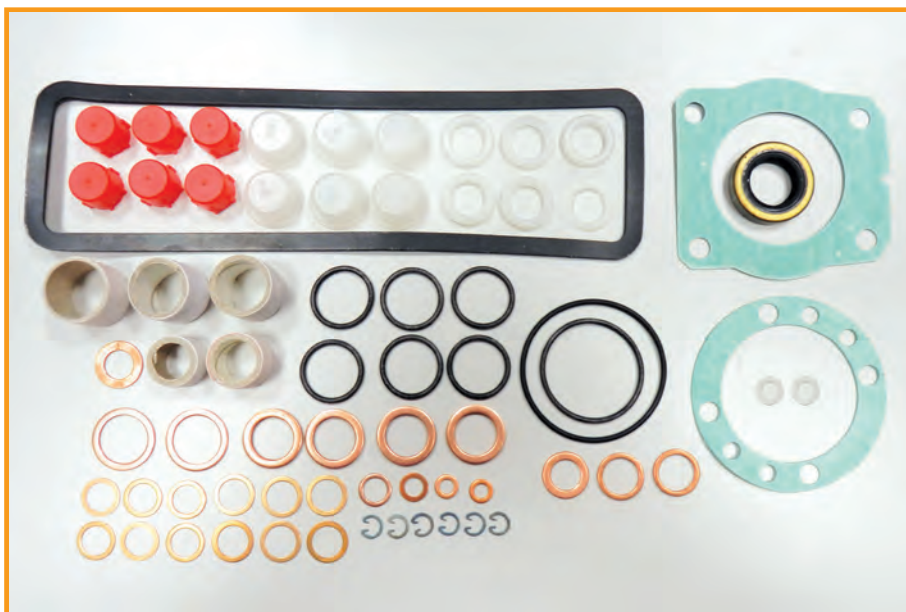

CODICE OMS 10-15-075

COD. Denso 190440-0350

COD.

COD.

COD.

TIPO-TYPE PE 6A

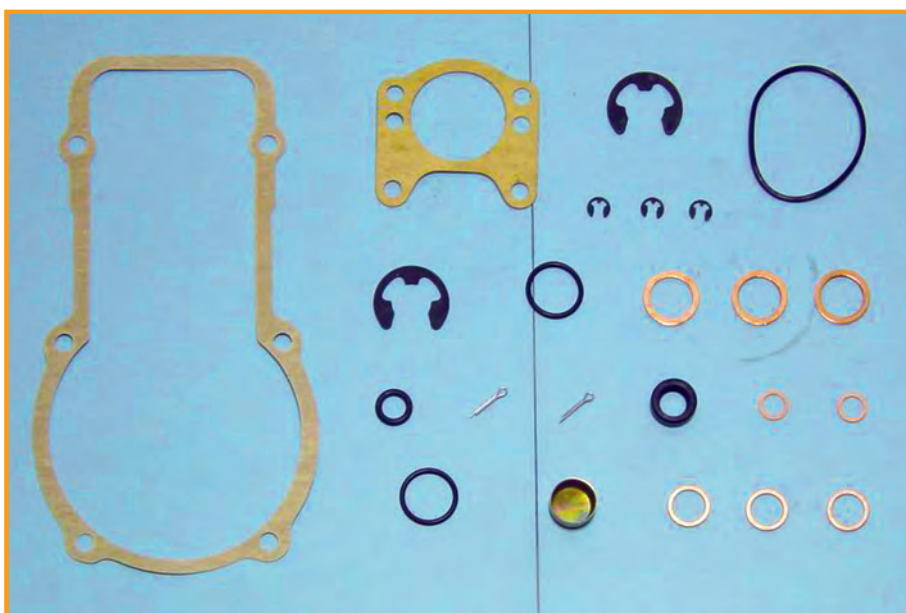

CODICE OMS 10-15-076

COD. Denso 190890-0150

COD.

COD.

COD.

TIPO-TYPE RSV



CODICE OMS 10-15-077

COD. Denso 190890-0160

COD.

COD.

COD.

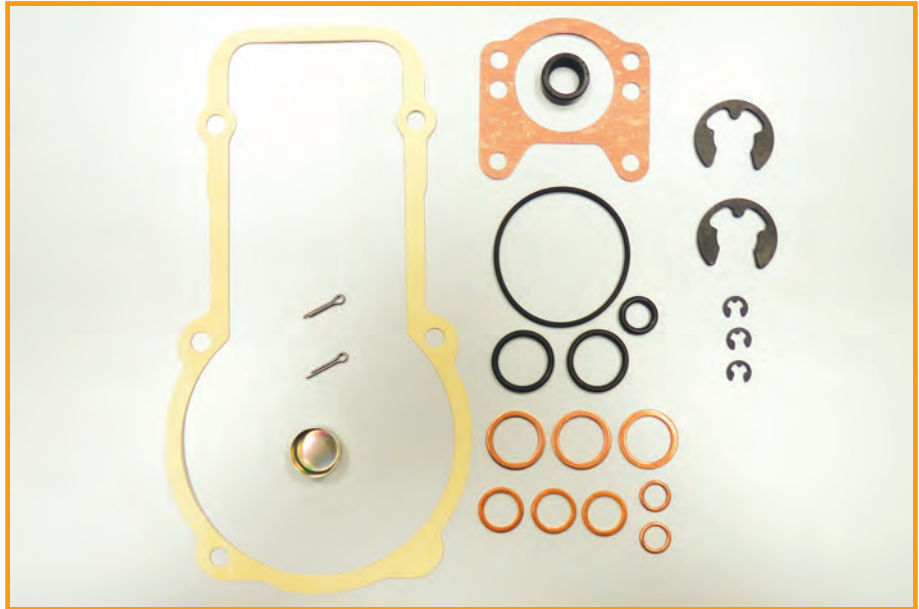

TIPO-TYPE RSV

CODICE OMS 10-15-078

COD. Denso 190890-0170

COD.

COD.

COD.

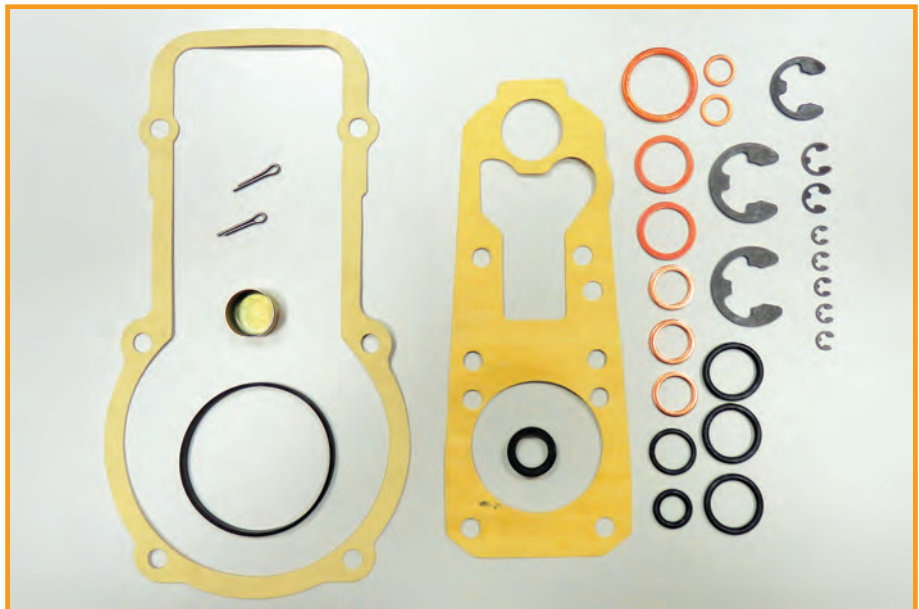

TIPO-TYPE RSV

CODICE OMS 10-15-079

COD. Denso 190890-0180

COD.

COD.

COD.



TIPO-TYPE RSV

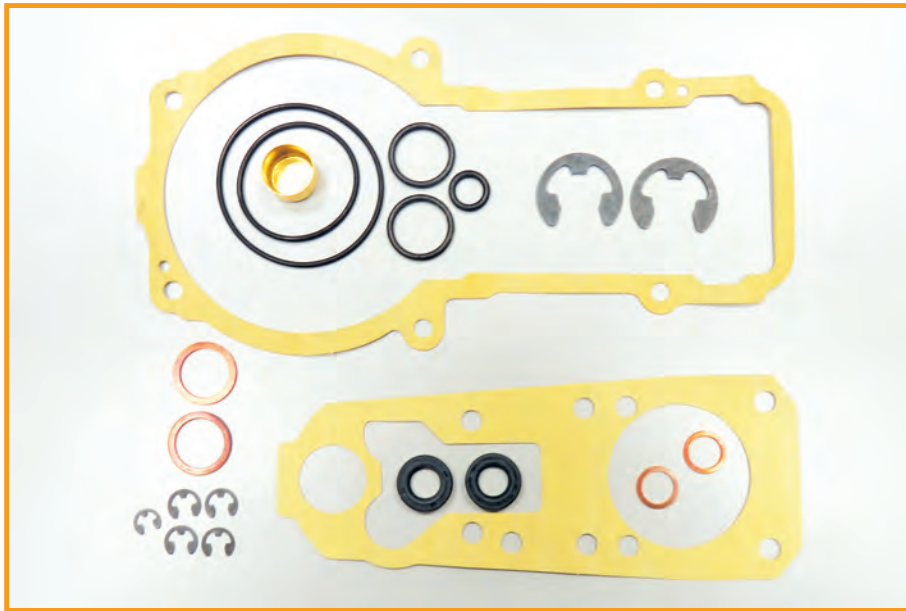

CODICE OMS 10-15-080

COD. Denso 190890-0190

COD.

COD.

COD.

TIPO-TYPE R721 / R722

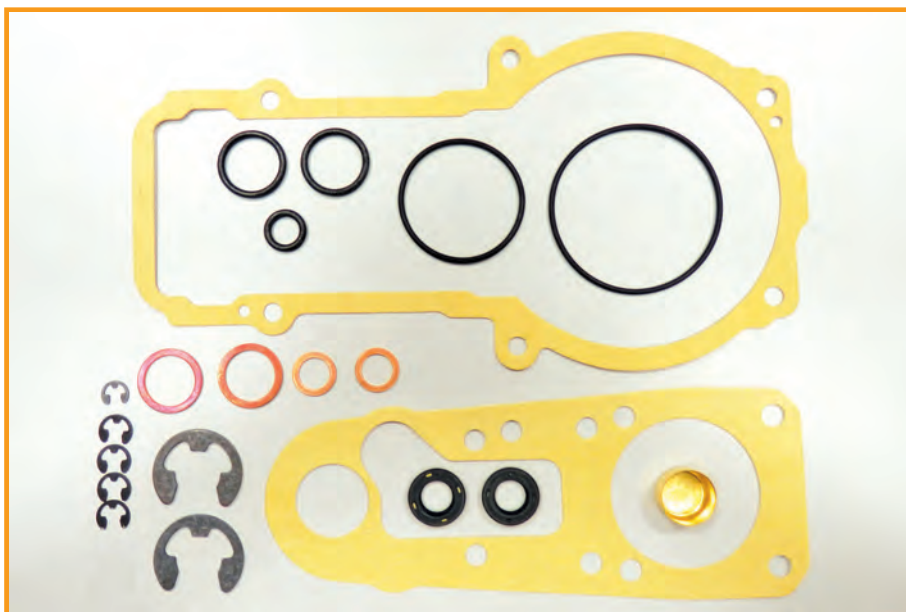

CODICE OMS 10-15-081

COD. Denso 190890-0200

COD.

COD.

COD.

TIPO-TYPE R721 / R722

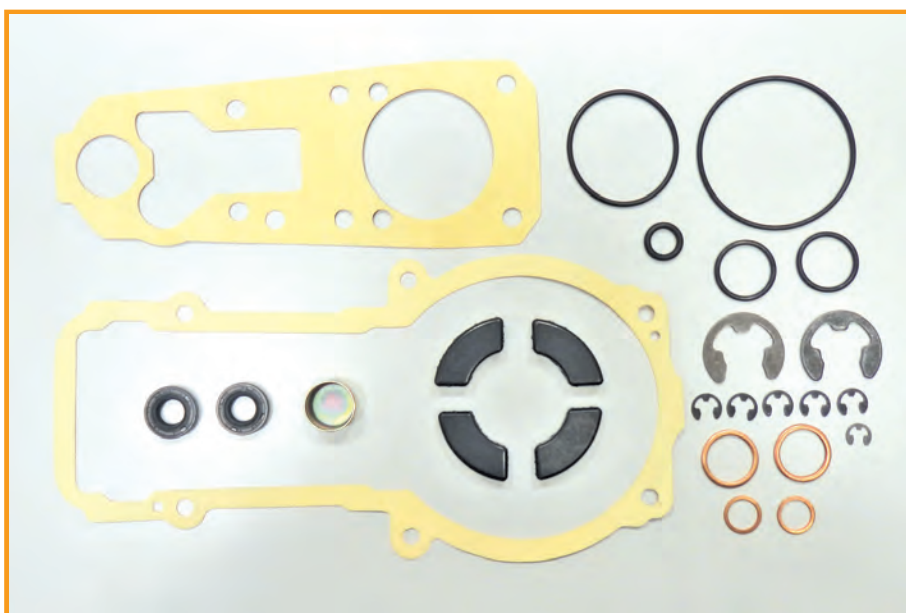

CODICE OMS 10-15-082

COD. Denso 190890-0210

COD.

COD.

COD.

TIPO-TYPE R811-R812-R832



CODICE OMS 10-15-084

COD. Denso 190890-0230

COD.

COD.

COD.

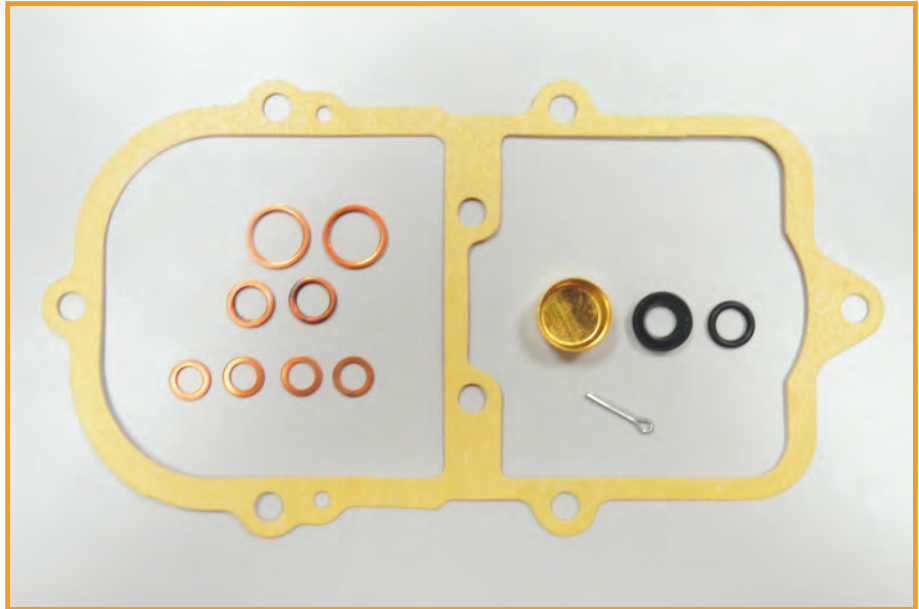

TIPO-TYPE Combined governor

CODICE OMS 10-15-085

COD. Denso 190890-0240

COD.

COD.

COD.

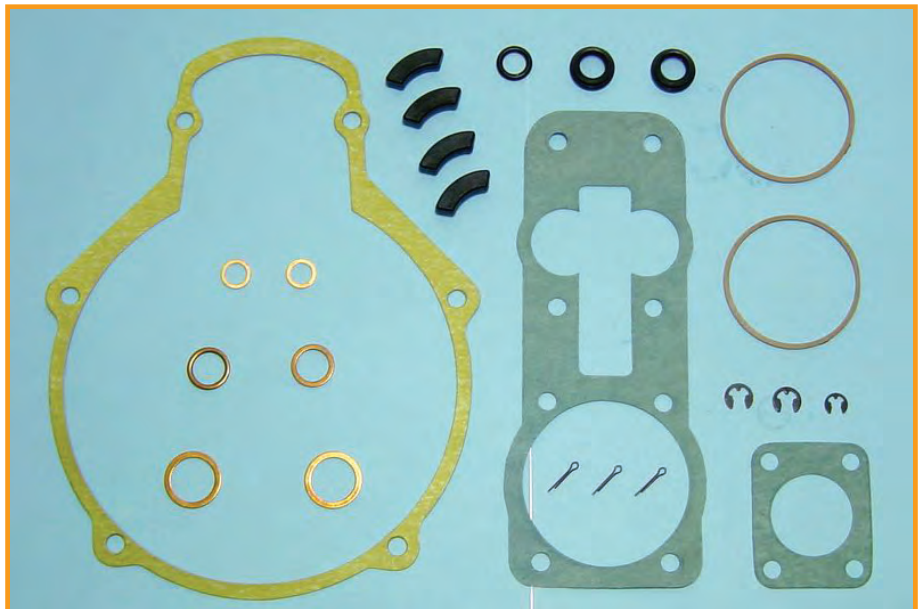

TIPO-TYPE RQR

CODICE OMS 10-15-086

COD. Denso 190890-0270

COD.

COD.

COD.



TIPO-TYPE R801

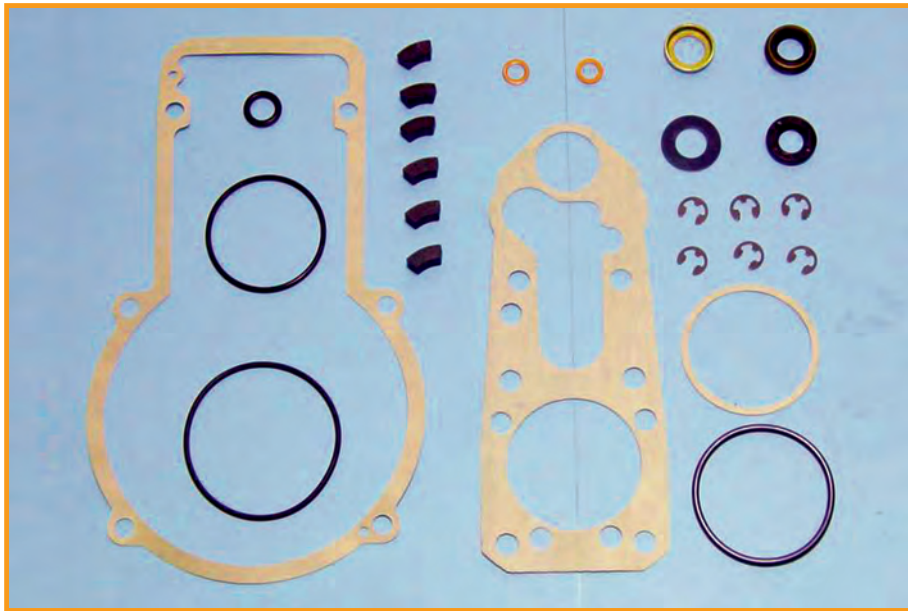

CODICE OMS 10-15-087

COD. Denso 190890-0271

COD. _____

COD. _____

COD. _____

TIPO-TYPE R801

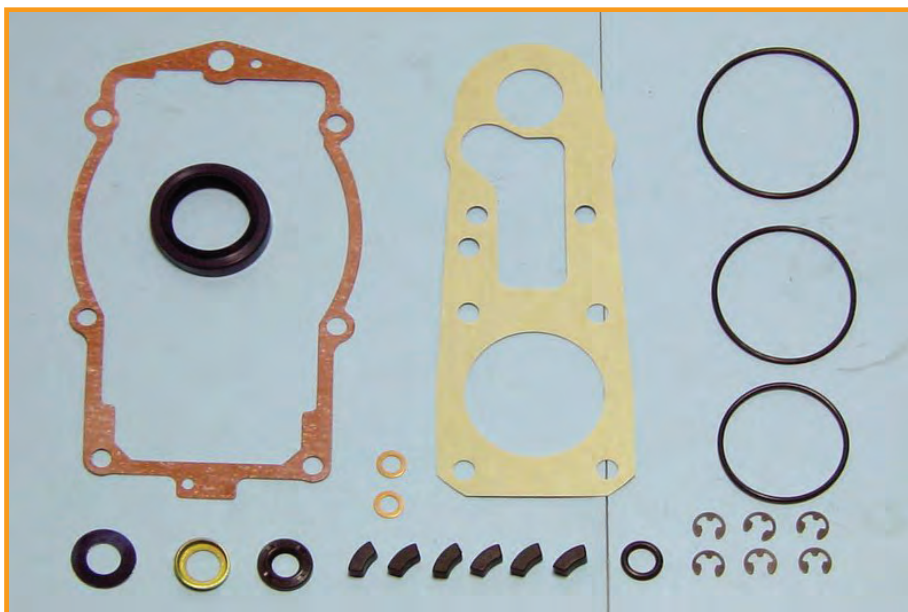

CODICE OMS 10-15-088

COD. Denso 190890-0280

COD. _____

COD. _____

COD. _____

TIPO-TYPE R801



CODICE OMS 10-15-089

COD. Denso 190890-0281

COD. _____

COD. _____

COD. _____

TIPO-TYPE R801



CODICE OMS 10-15-090

COD. Zexel GKIT4A-T400

COD.

COD.

COD.

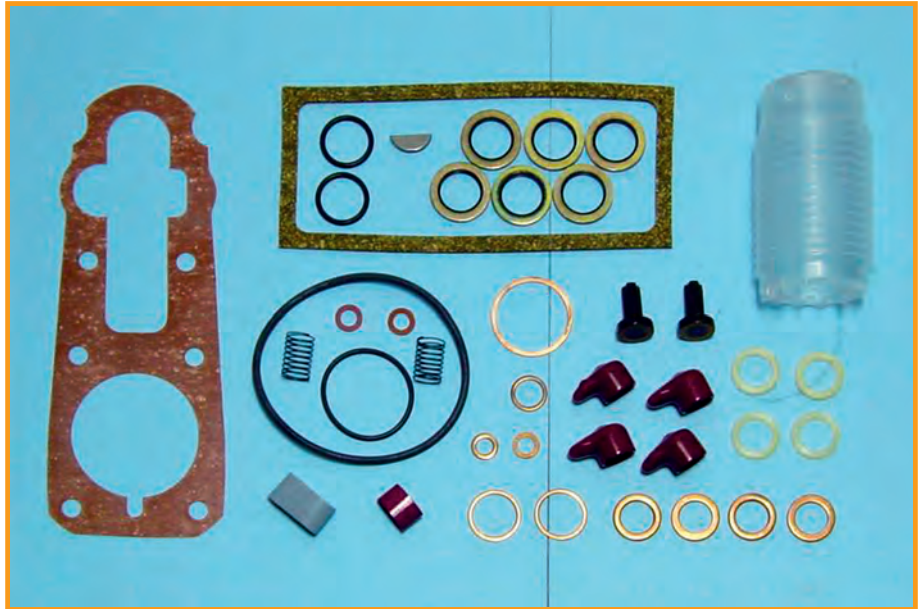

TIPO-TYPE PES 4A

CODICE OMS 10-15-091

COD. Zexel 131499-2020

COD.

COD.

COD.



TIPO-TYPE PES 4A

CODICE OMS 10-15-092

COD. Zexel 146600-1120

COD. Bh 9 461 610 423

COD.

COD.



TIPO-TYPE EP/VE

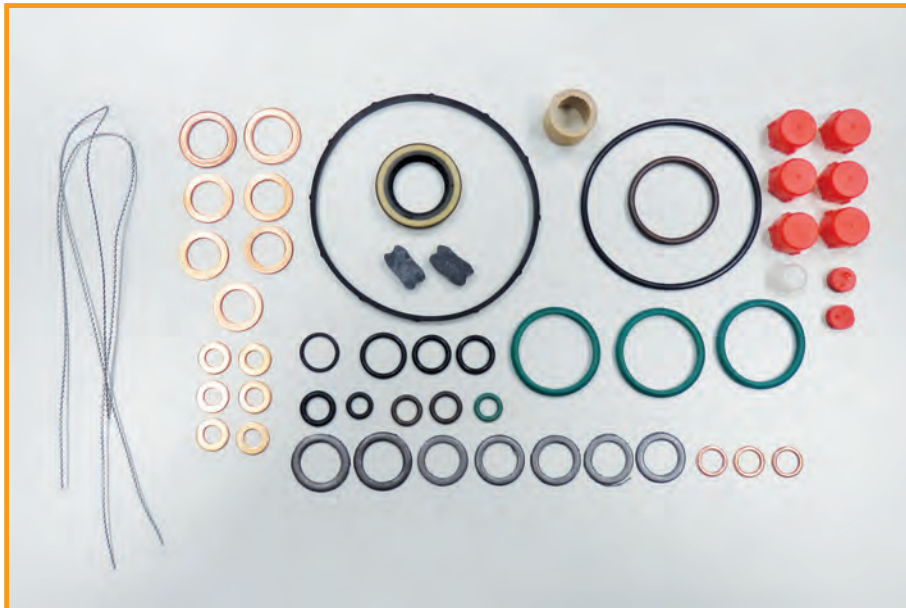

CODICE OMS 10-15-092/1

COD. Zexel 146600-1120

COD. Bh 9 461 610 423

COD.

COD.

Paraolio 20x30x7

TIPO-TYPE EP/VE

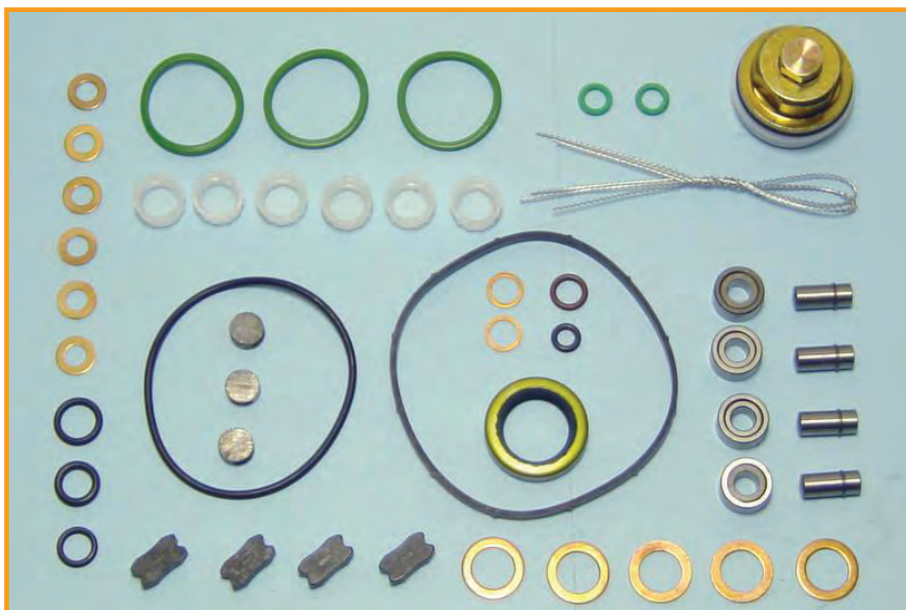

CODICE OMS 10-15-092/2

COD. Zexel 146600-1120

COD. Bh 9 461 610 423

COD.

COD.

Punterie con clip
Paraolio 20X30X7

TIPO-TYPE EP/VE



CODICE OMS 10-15-093

COD. Zexel 154599-1020

COD. Bh 9 421 611 407

COD.

COD.

TIPO-TYPE EP RSV



CODICE OMS 10-15-094

COD. Zexel 154599-1220

COD. Bh 9 421 611 409

COD.

COD.

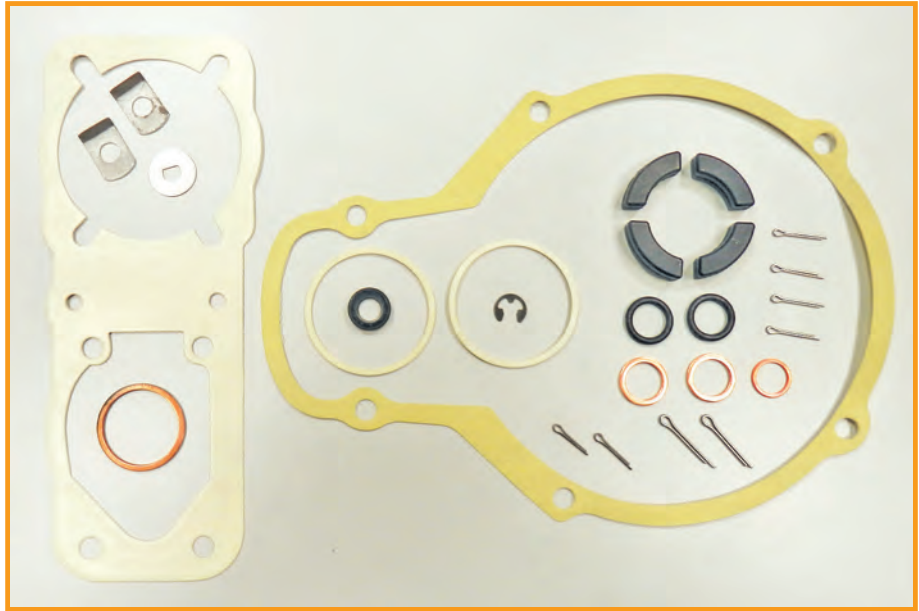

TIPO-TYPE RQ..P

CODICE OMS 10-15-094/1

COD.

COD.

COD.

COD.

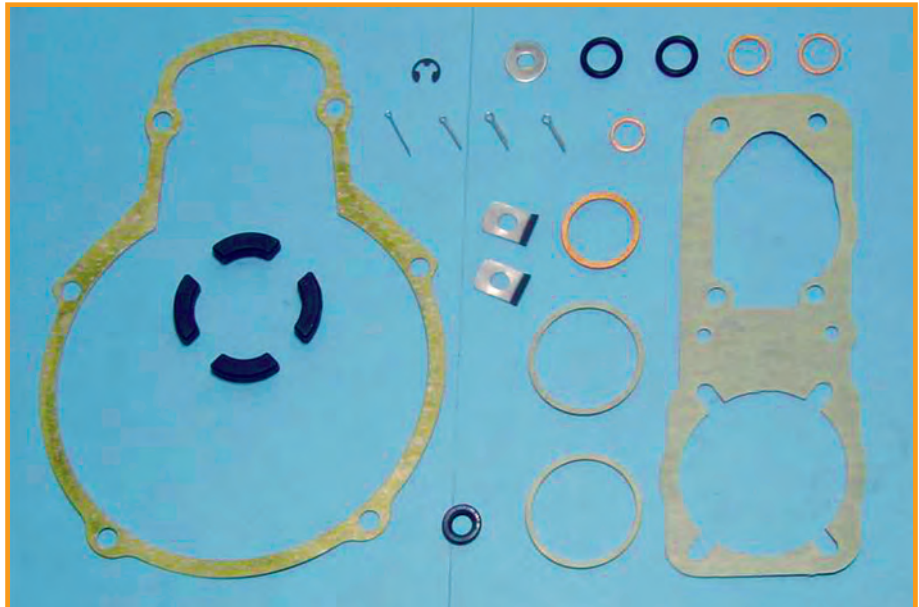

TIPO-TYPE RQ..P

CODICE OMS 10-15-095

COD. Zexel 154599-0720

COD. Bh 9 421 611 404

COD.

COD.

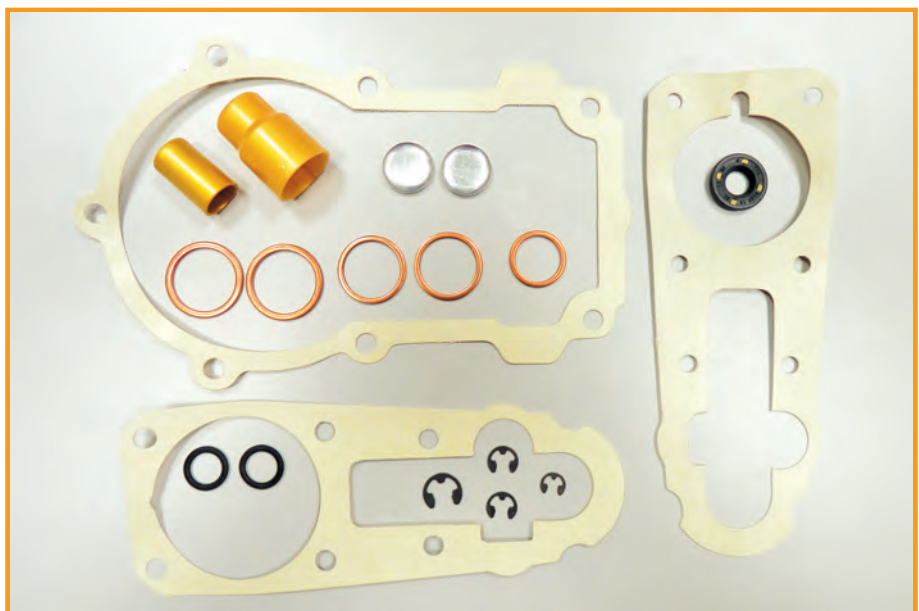

TIPO-TYPE RLD-A-B

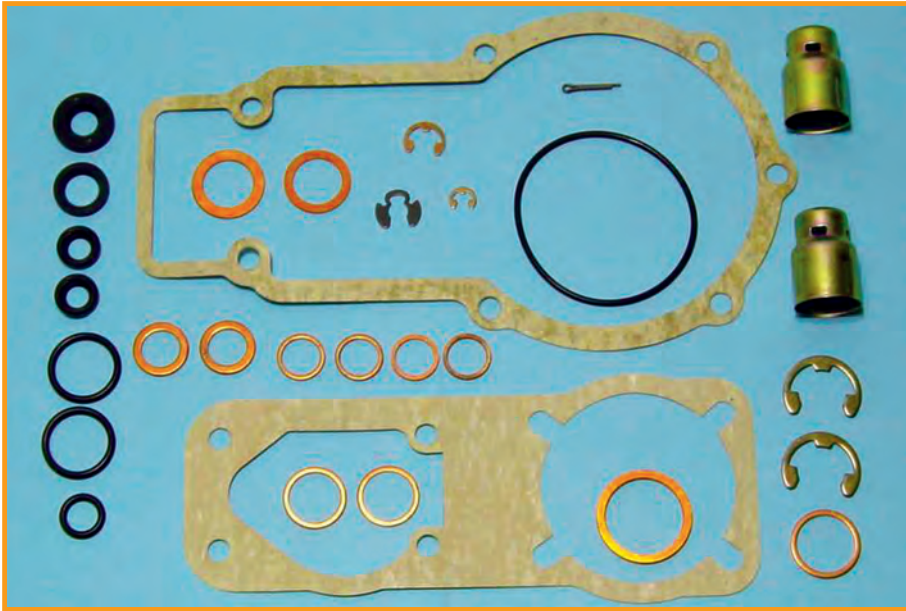

CODICE OMS 10-15-096

COD. Zexel 154599-0620

COD. Bh 9 421 611 403

COD.

COD.

TIPO-TYPE RFD-D

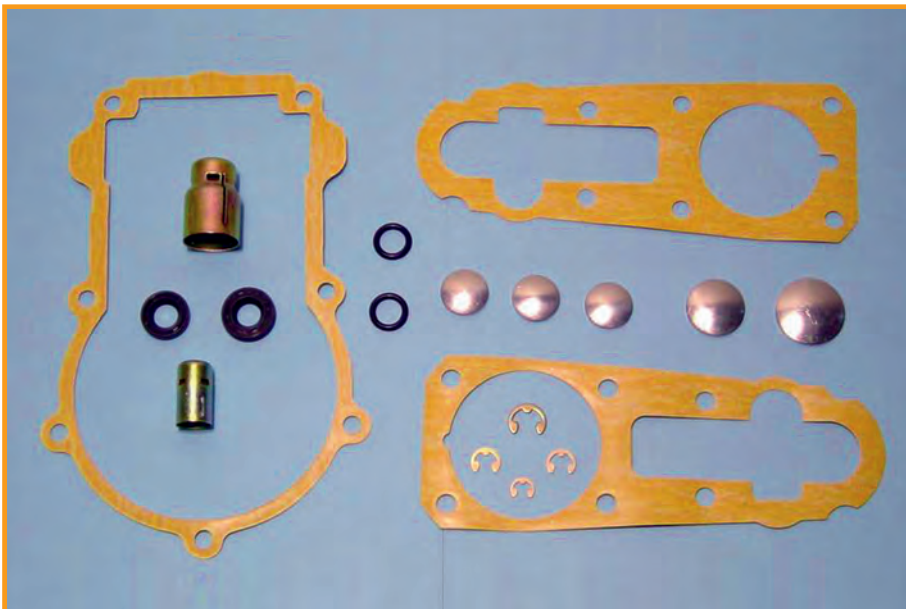

CODICE OMS 10-15-097

COD. Zexel 154599-0820

COD. Bh 9 421 611 405

COD.

COD.

TIPO-TYPE RLD-E-F

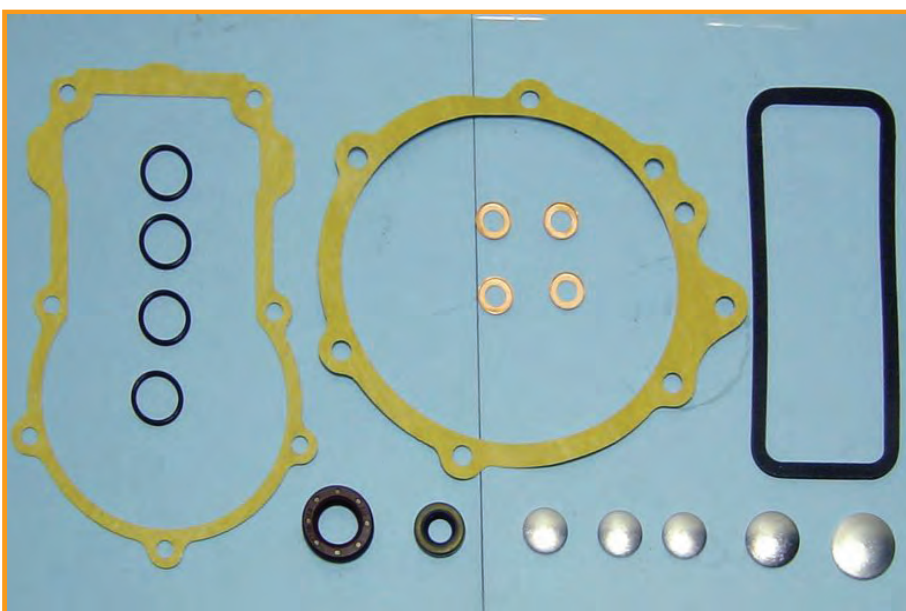

CODICE OMS 10-15-097/1

COD. Zexel

COD.

COD.

COD.

Tipo RLD-E-F

TIPO-TYPE PES..4A



CODICE OMS 10-15-097/2

COD. Zexel

COD.

COD.

COD.

Tipo RLD-E-F

TIPO-TYPE PES..6A

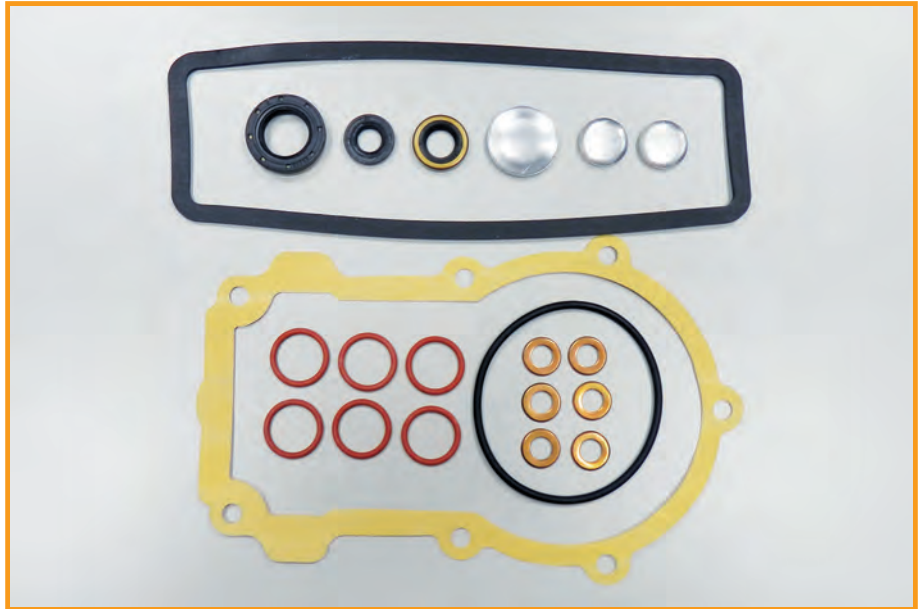

CODICE OMS 10-15-098

COD. Zexel 154599-1120

COD. Bh 9 421 611 408

COD.

COD.

TIPO-TYPE RBD-A

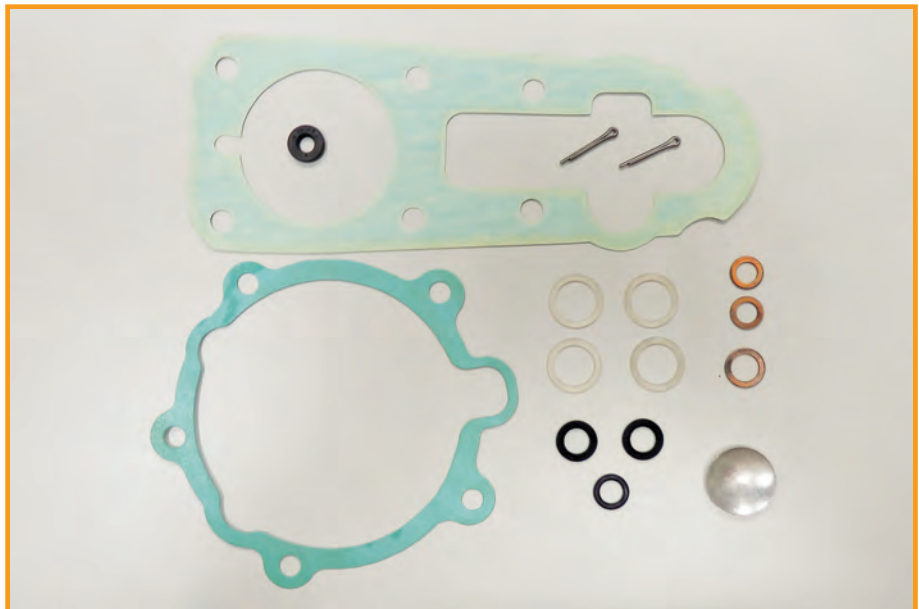

CODICE OMS 10-15-099

COD. Zexel 154599-0420

COD. Bh 9 411 611 001

COD.

COD.

TIPO-TYPE PES(S)..10P

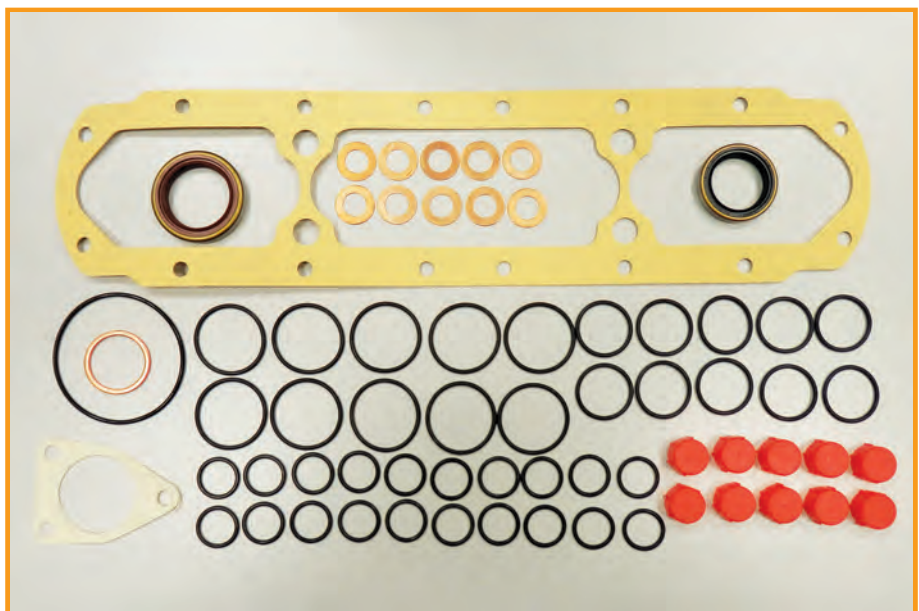

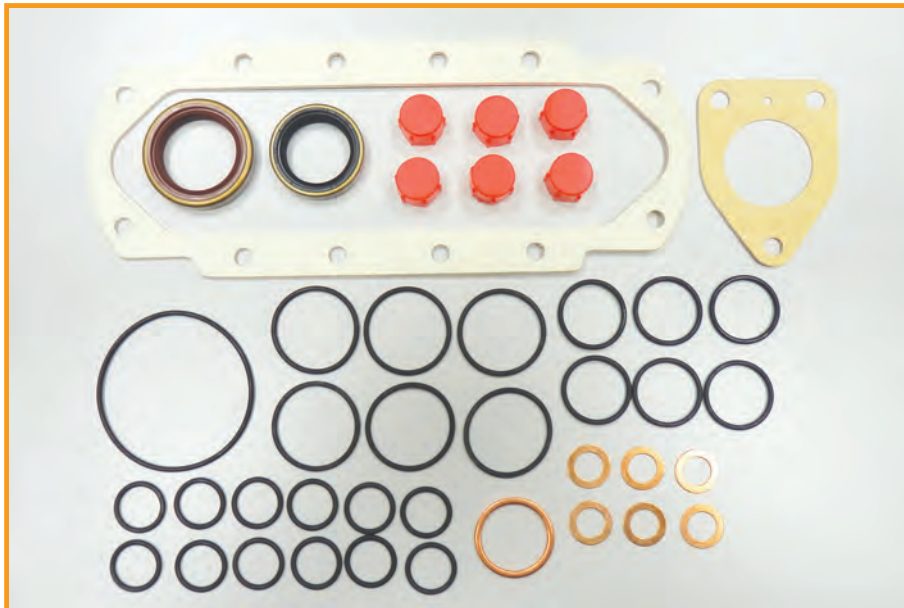

CODICE OMS 10-15-100

COD. Zexel 134599-0220

COD.

COD.

COD.

TIPO-TYPE PE(S)6P

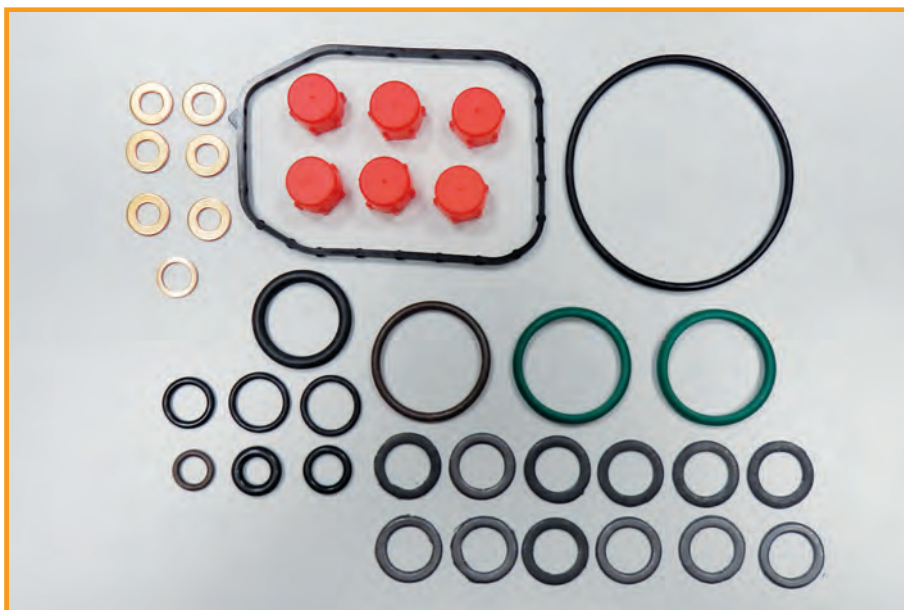

CODICE OMS 10-15-102

COD. Zexel 146600-4620

COD. Bh 9 461 617 567

COD.

COD.

TIPO-TYPE VE

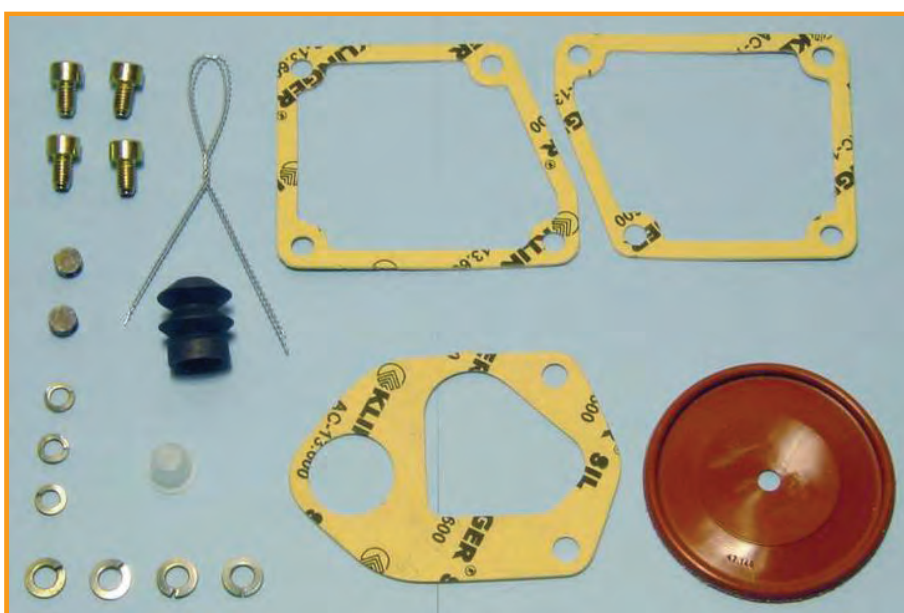

CODICE OMS 10-15-105

COD. Bh 9 421 080 068

COD. GK 229

COD.

COD.

Volvo - Scania - Pegaso
Membrana con foro \varnothing 6 mm

TIPO-TYPE LDA



CODICE OMS 10-15-105/1

COD. Bh 9 421 080 068

COD.

COD.

COD.

Volvo - Scania - Pegaso
Membrana con foro Ø 8 mm

TIPO-TYPE LDA

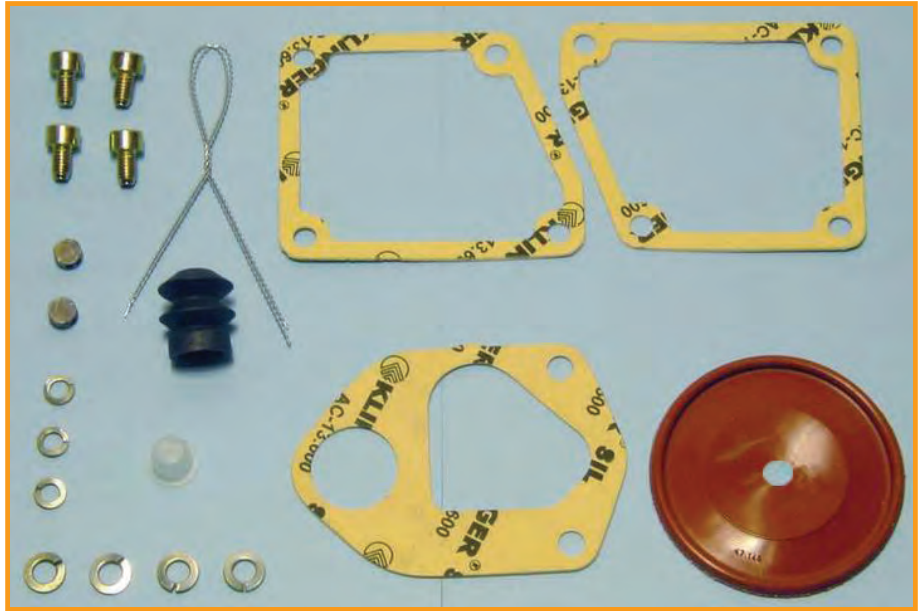

CODICE OMS 10-15-109

COD. Zexel 131499-2120

COD.

COD.

COD.

TIPO-TYPE PE(S)4A..D



CODICE OMS 10-15-110

COD. Zexel 131499-2420

COD.

COD.

COD.

TIPO-TYPE PE(S)6A..D

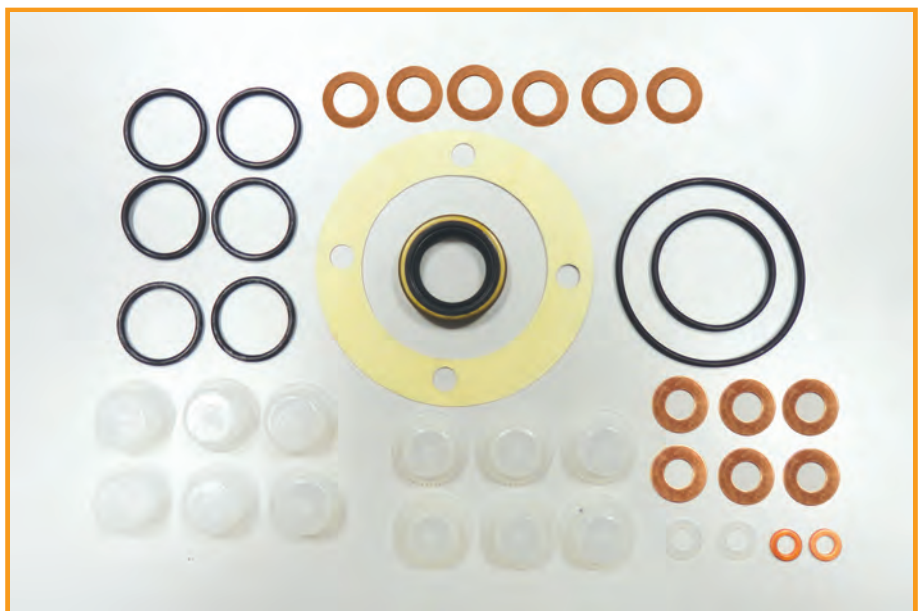

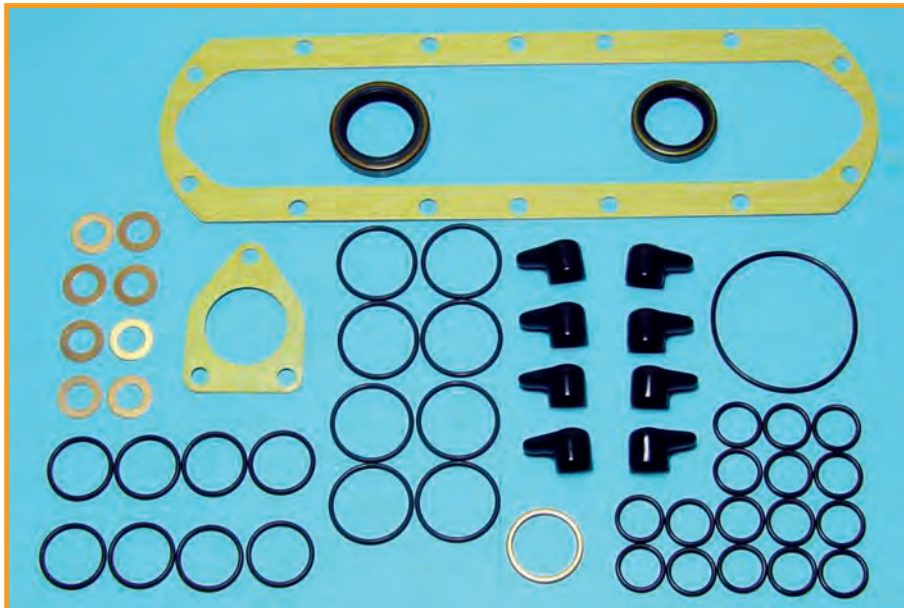

CODICE OMS 10-15-112

COD. Zexel 134599-0320

COD.

COD.

COD.

TIPO-TYPE PE(S)8P

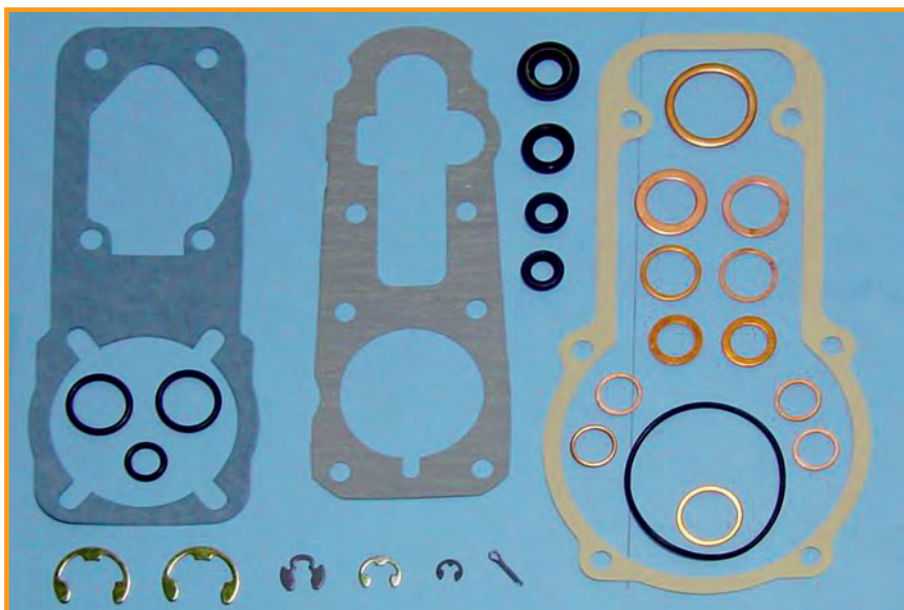

CODICE OMS 10-15-115

COD. Zexel 154599-0520

COD. Bh 9 421 611 402

COD.

COD.

TIPO-TYPE RFD-B-C

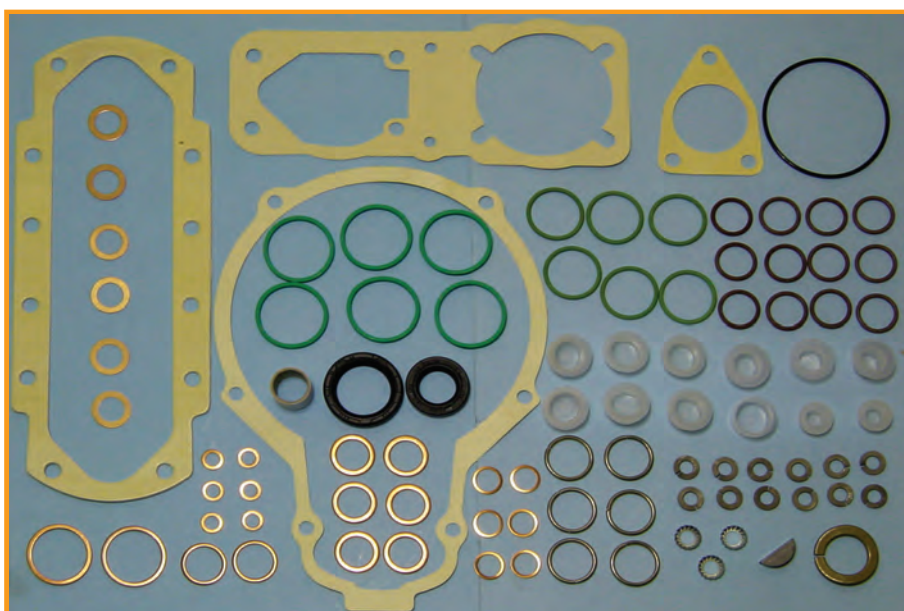

CODICE OMS 10-15-116

COD. Bh 2 417 010 001/D

COD.

COD.

COD.

Come 10-15-014 + guarnizione RQV
Con guarnizioni Lobo 2 Anelli tenuta $\varnothing 25 \times \varnothing 35 \times 7$ $\varnothing 17 \times \varnothing 28 \times 7$

TIPO-TYPE PES(S) 6PA



CODICE OMS 10-15-116/1

COD. Bh 2 417 010 001/E

COD.

COD.

COD.

Con guarnizioni Oval 

1 Anello tenuta $\varnothing 25 \times \varnothing 35 \times 7$ +2 $\varnothing 11 \times \varnothing 17 \times 4$

TIPO-TYPE PES(S) 6PA

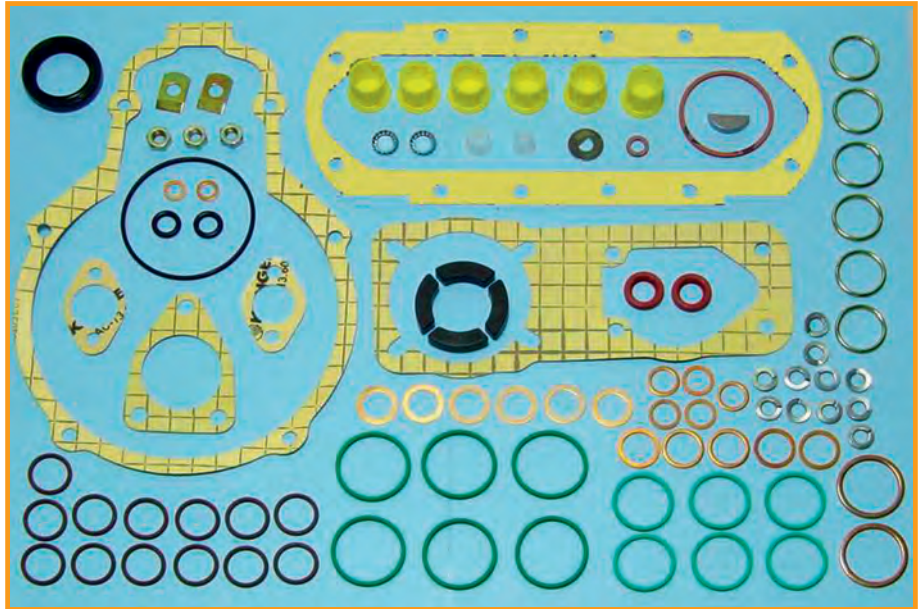

CODICE OMS 10-15-116/2

COD. Bh 2 417 010 001/F

COD.

COD.

COD.

Con guarnizioni Oval 

1 Anello tenuta $\varnothing 25 \times \varnothing 35 \times 7$

TIPO-TYPE PES(S) 6PA

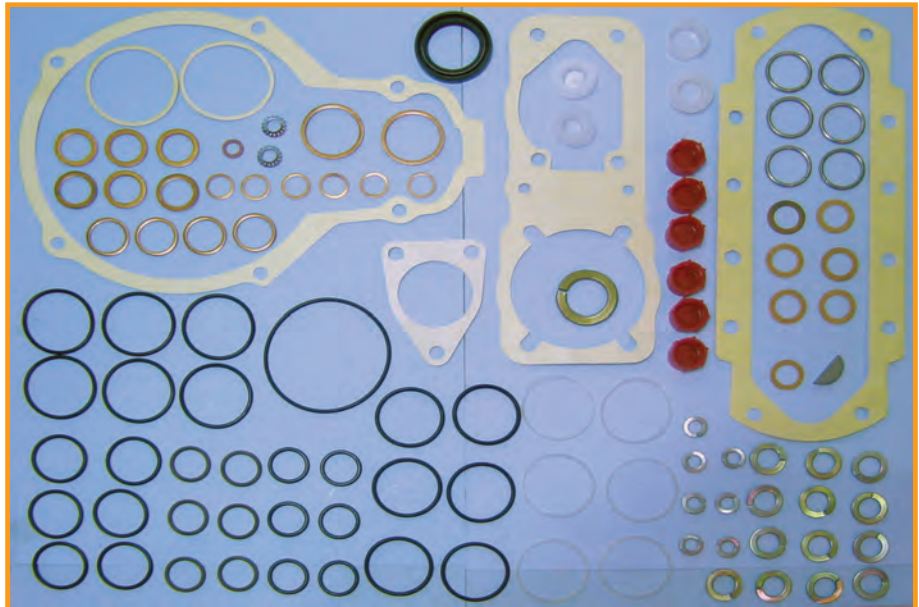

CODICE OMS 10-15-117

COD. Bh 1 467 010 059/1

COD.

COD.

COD.

Come 10-15-001 + 3 paraolio

17x28x7 Ferro-Gomma
20x31x7 Ferro-Gomma
20x30x7 Rettificato-20x31x7 Ferro-Gomma

TIPO-TYPE EP/VE





CODICE OMS 10-15-118

COD. Bh 2 427 010 049

COD. _____

COD. _____

COD. _____

TIPO-TYPE RQ/RQV..PA..MW

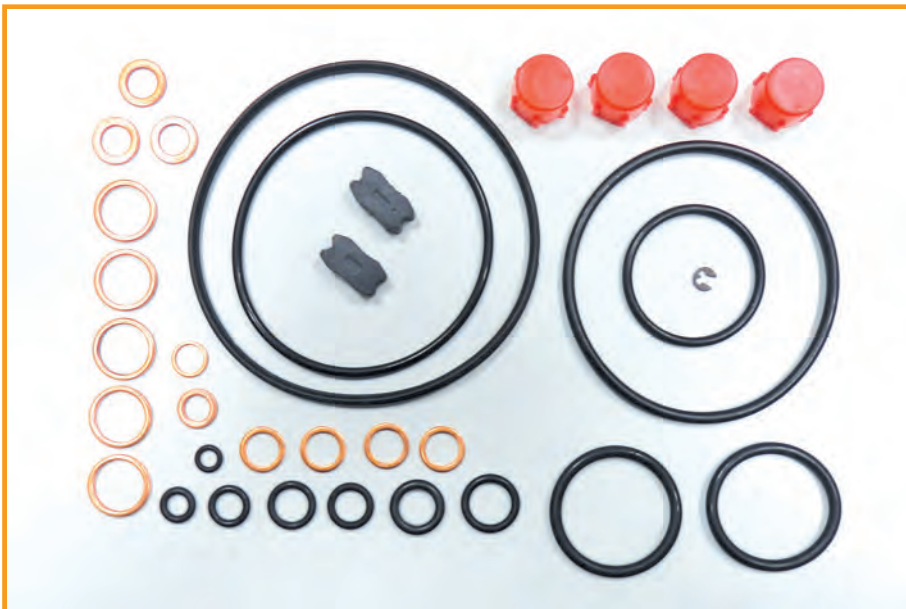

CODICE OMS 10-15-119

COD. 096010-0030

COD. _____

COD. _____

COD. _____

TIPO-TYPE VE Turbo



CODICE OMS 10-15-120

COD. Bh 2 417 010 027

COD. _____

COD. _____

COD. _____

TIPO-TYPE PE 12P..S3000..H..D..



CODICE OMS 10-15-120/1

COD.	Bh 2 417 010 027
COD.	Mercedes - Man
COD.	
COD.	

TIPO-TYPE PE 12P..S3000..

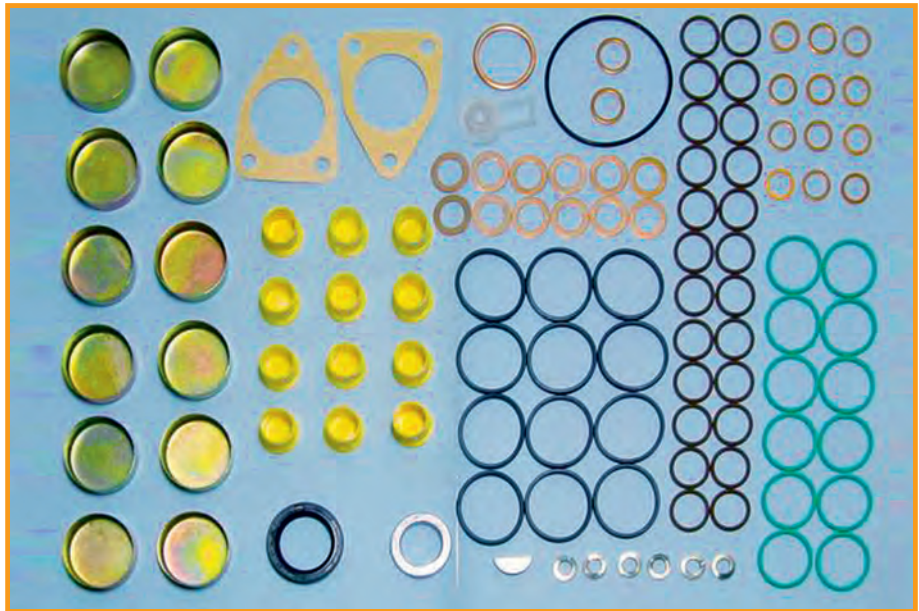

CODICE OMS 10-15-120/2

COD.	Bh 2 417 010 027
COD.	Mercedes - Man
COD.	
COD.	

TIPO-TYPE PE 12P..S3000..

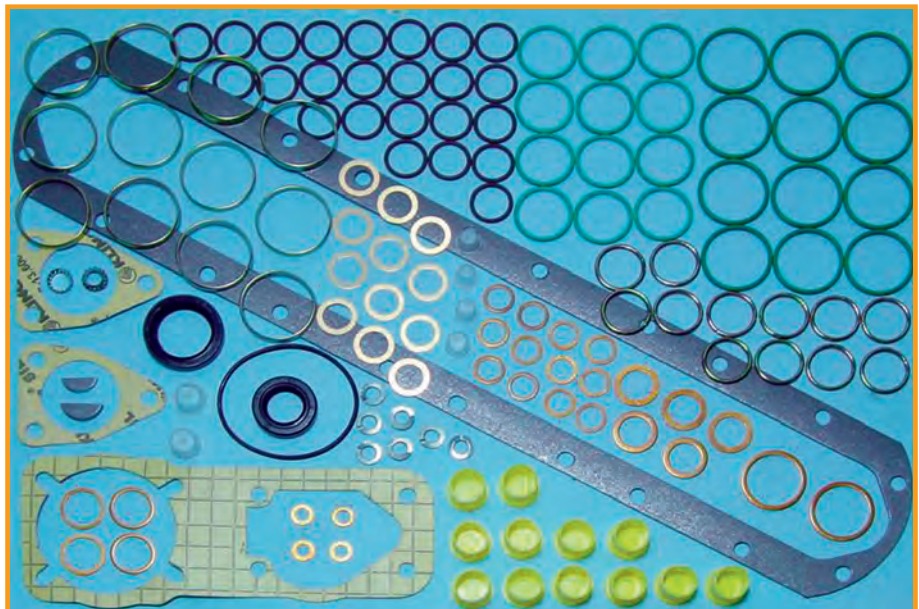

CODICE OMS 10-15-121

COD.	Bh 2 417 010 025
COD.	
COD.	
COD.	

TIPO-TYPE PE(S)6P..S300..H..D..

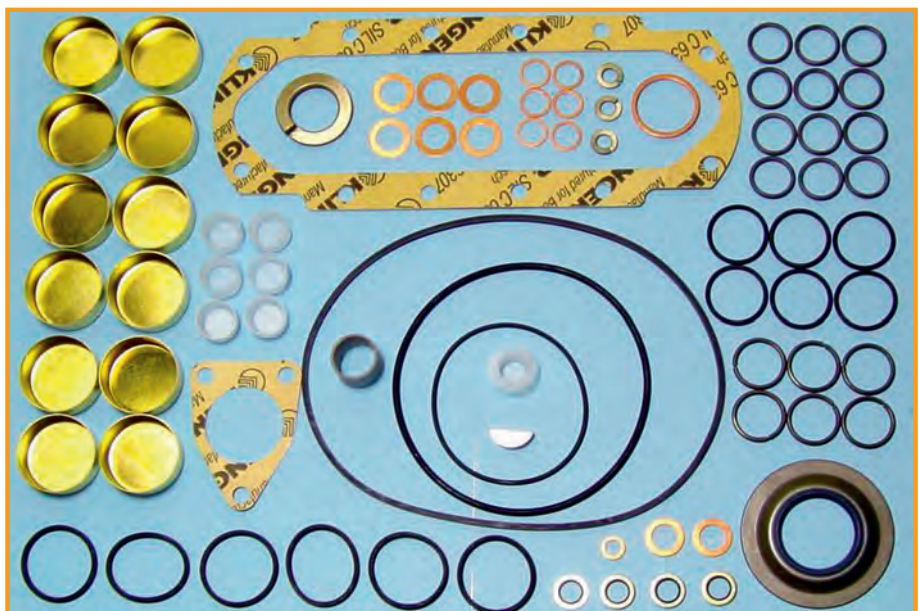



CODICE OMS 10-15-122

COD. Bh 2 417 010 045

COD.

COD.

COD.

TIPO-TYPE PE(S)6H+RE 33



CODICE OMS 10-15-123

COD. Bh 2 417 010 048

COD.

COD.

COD.

TIPO-TYPE PE(S)4/8H+RE 36

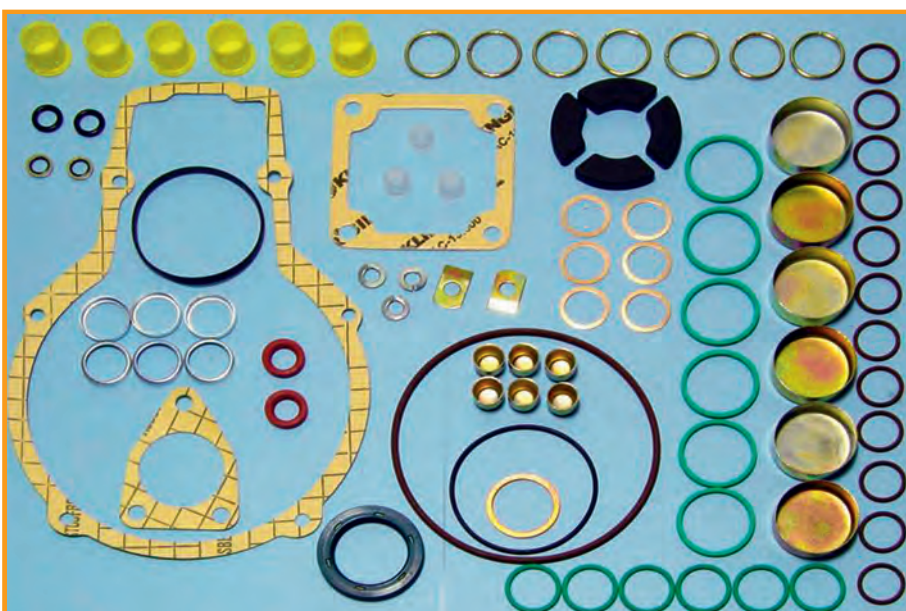

CODICE OMS 10-15-124

COD.

COD.

COD.

COD.

TIPO-TYPE 6 CILINDRI TIPO 7100 + GOVERNOR K APPLICATION



CODICE OMS 10-15-125

COD. Bh 2 417 010 047

COD.

COD.

COD.



TIPO-TYPE PE(S)4/8H+RE 33

CODICE OMS 10-15-126

COD. Bh 2 417 010 046

COD.

COD.

COD.

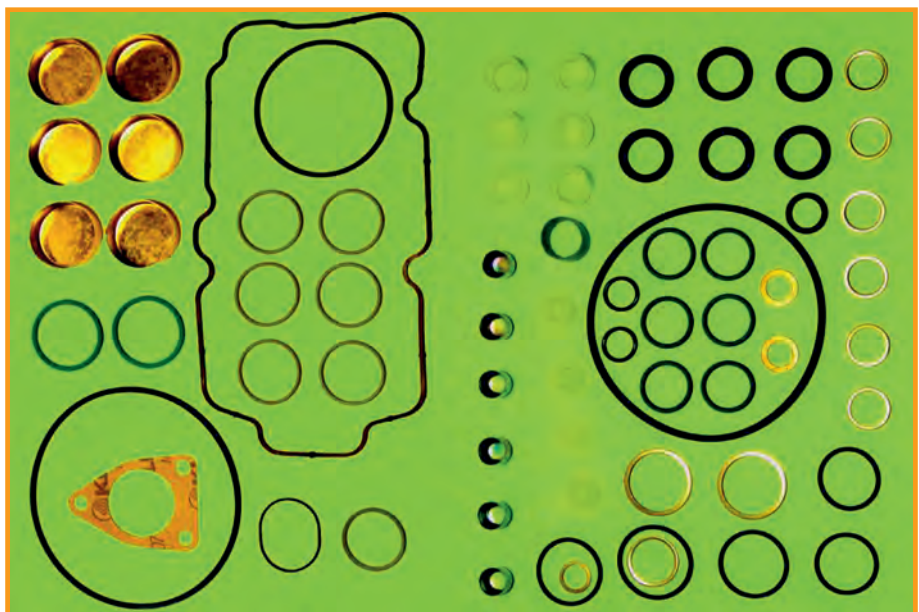

TIPO-TYPE PE(S)6H+RE 36

CODICE OMS 10-15-127

COD. Bh 2 417 010 040

COD.

COD.

COD.

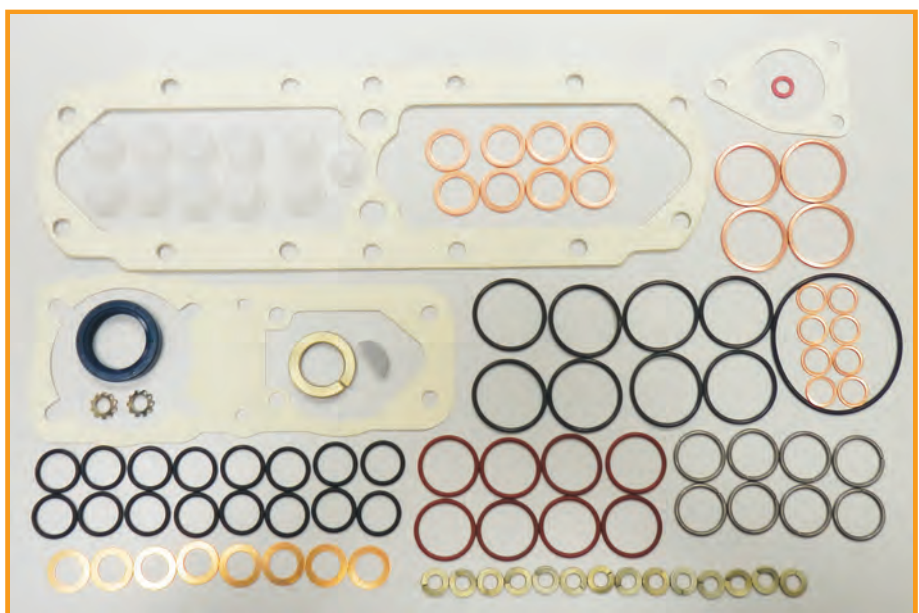

TIPO-TYPE PE 8P



CODICE OMS 10-15-128

COD. Bh 1 467 045 046

COD.

COD.

COD.

TIPO-TYPE VP 44



CODICE OMS 10-15-129

COD. Bh 2 467 010 002

COD.

COD.

COD.

TIPO-TYPE EP/VE...E.EDC

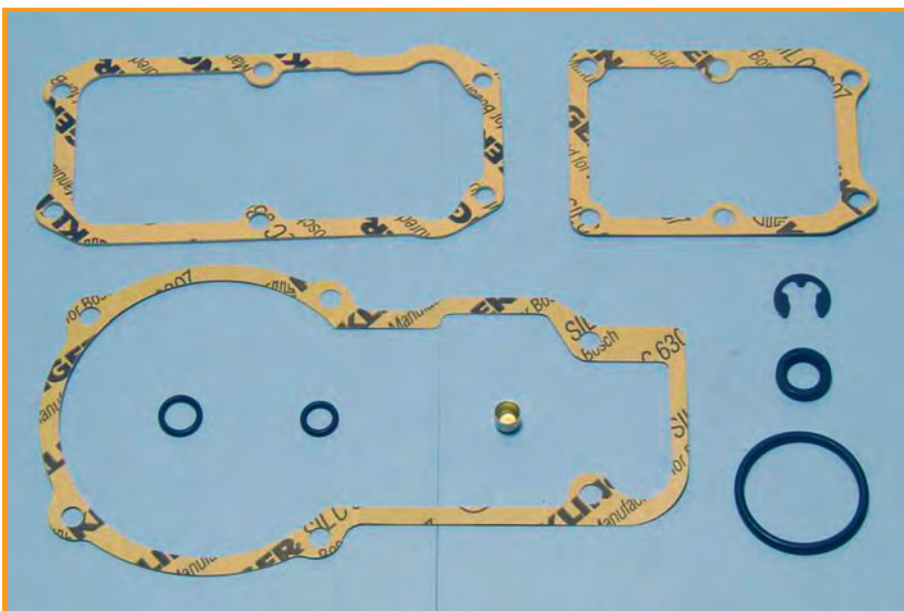

CODICE OMS 10-15-130

COD. Bh 1 427 010 010

COD.

COD.

COD.

TIPO-TYPE EP-VE/LDA

CODICE OMS 10-15-131

COD. 131499-2320

COD. Bh 9 411 610 991

COD.

COD.

Shaft 20 mm

TIPO-TYPE PE(S)6A

CODICE OMS 10-15-132

COD. 131499-2220

COD. Bh 9 411 610 990

COD.

COD.

Shaft 17 mm

TIPO-TYPE PE(S)6A

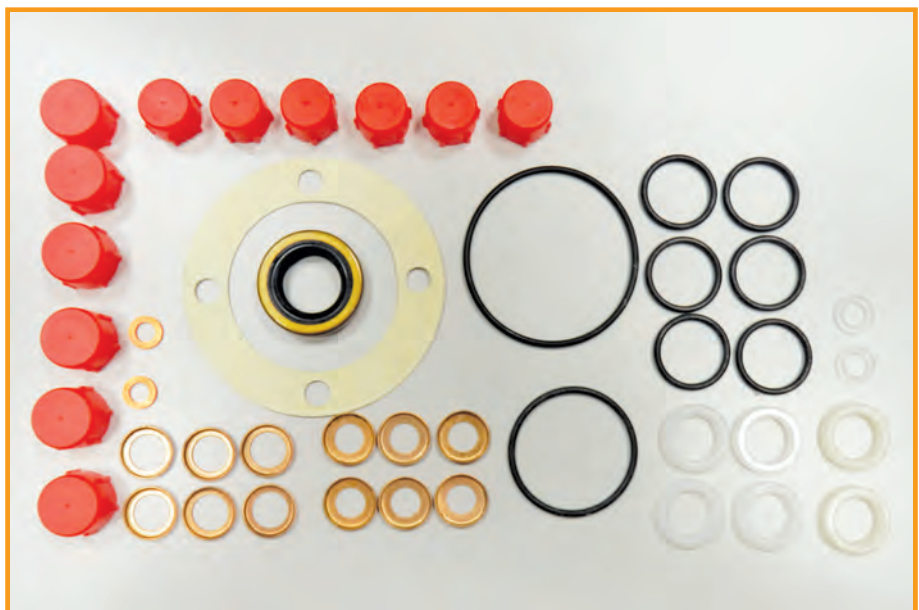
CODICE OMS 10-15-133

COD. KT 401705/04

COD.

COD.

COD.

AMBAC

TIPO-TYPE PML 6 cilindri

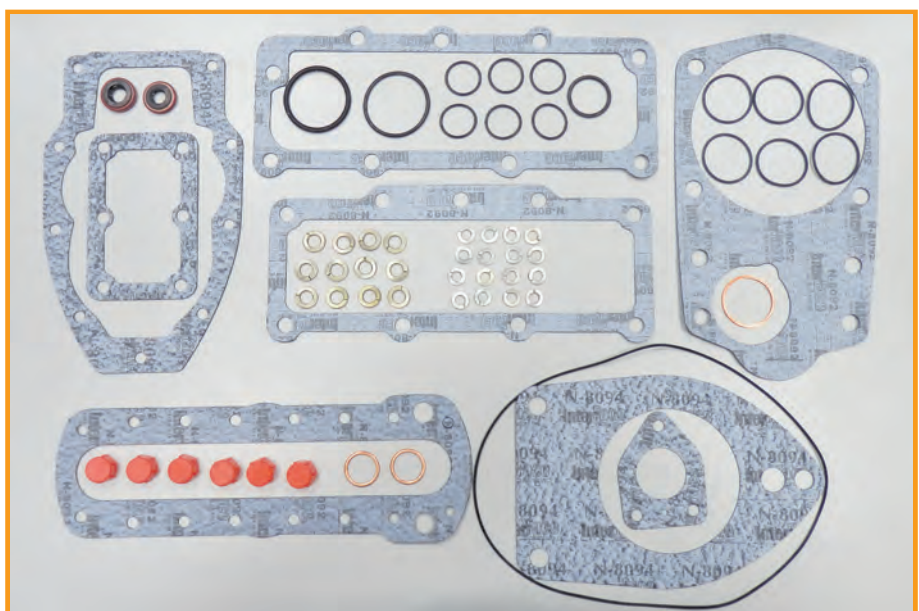

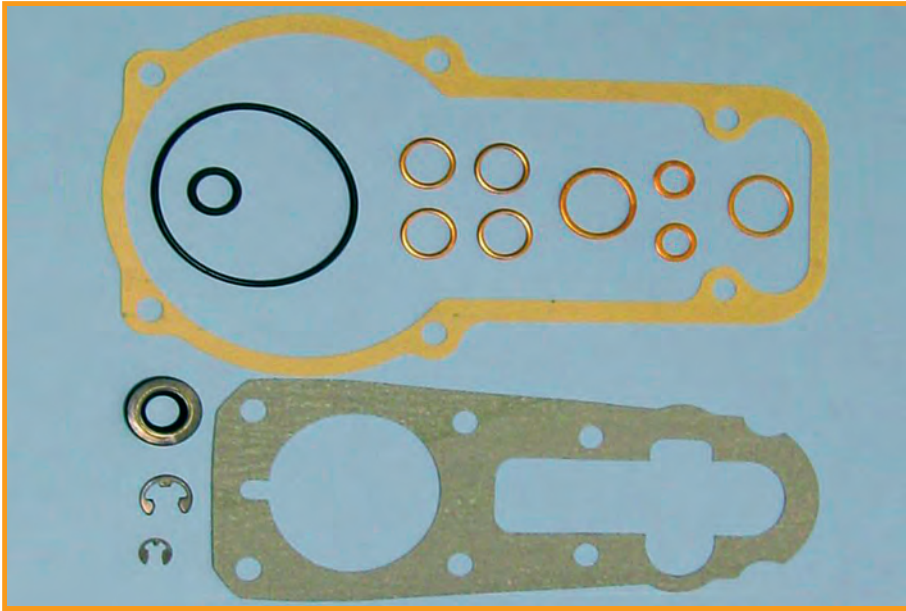

CODICE OMS 10-15-135

COD. Zexel 154599-0920

COD. Bh 9 421 611 406

COD.

COD.

TIPO-TYPE RADC

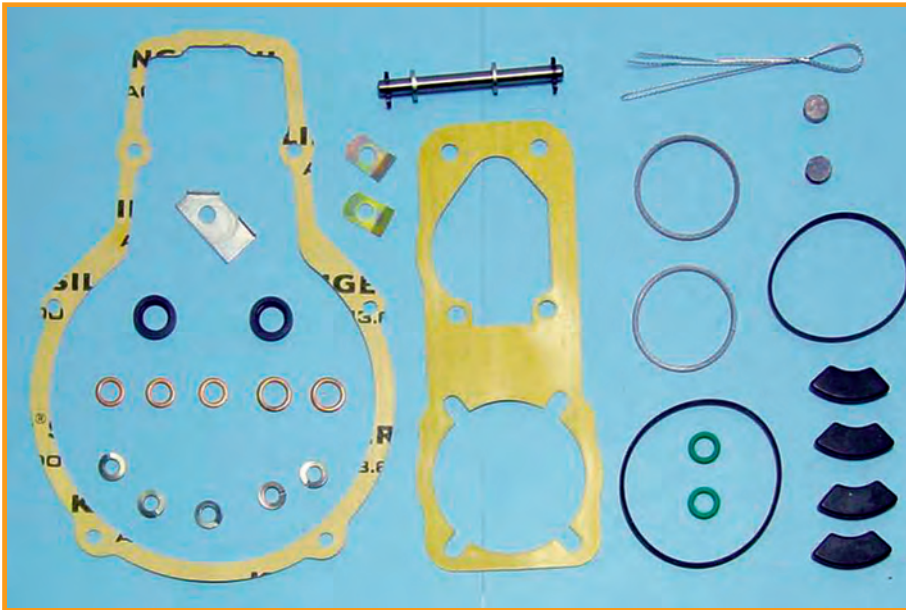

CODICE OMS 10-15-136

COD. Bh F 00 421 064

COD.

COD.

COD.

TIPO-TYPE Per K Governor

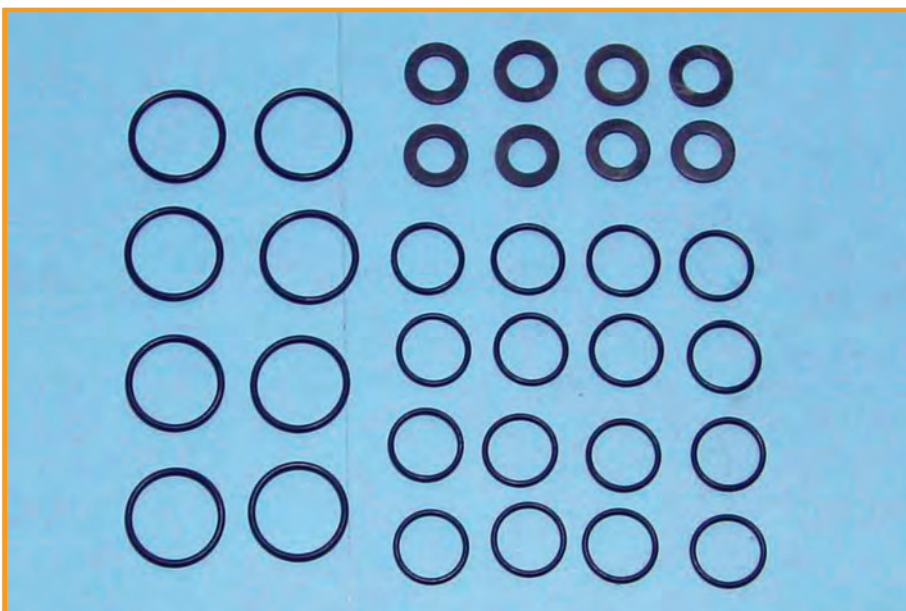

CODICE OMS 10-15-137

COD.

COD.

COD.

COD.

RENAULT MAGNUM

TIPO-TYPE MACK 400



CODICE OMS 10-15-139

COD. DGK 138

COD.

COD.

COD.

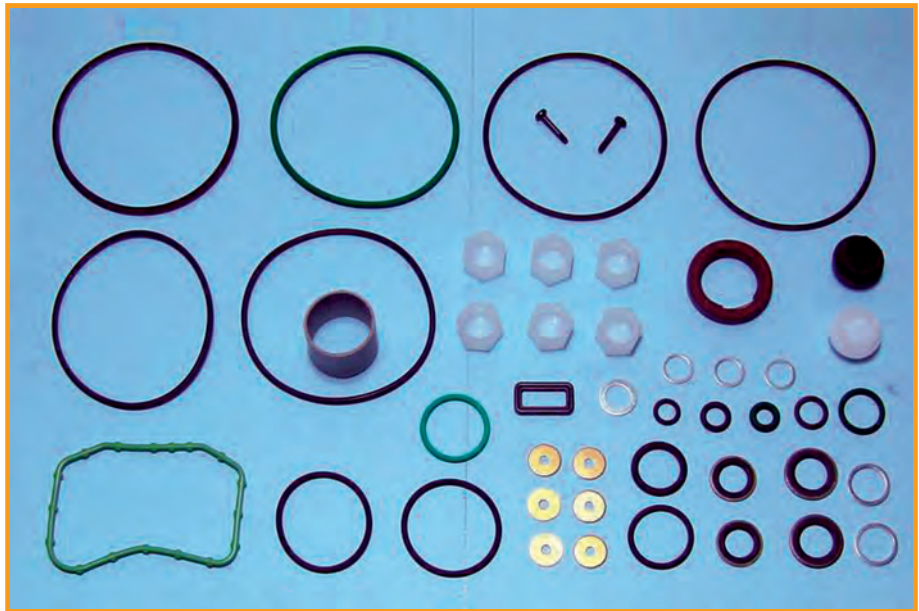

TIPO-TYPE

CODICE OMS 10-15-140

COD. Bh 2 417 010 002

COD.

COD.

COD.

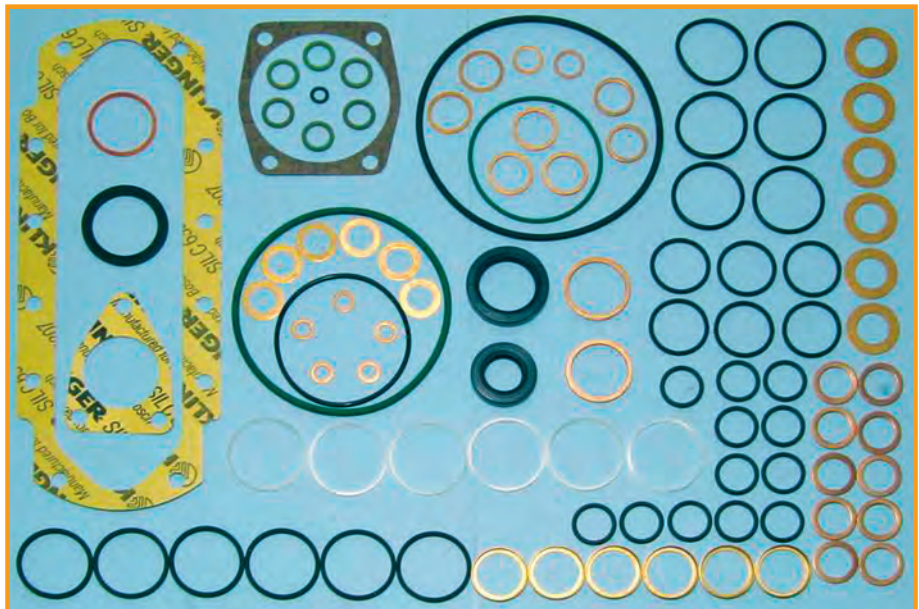

TIPO-TYPE PE 6P

CODICE OMS 10-15-141

COD. Bh 2 417 010 038

COD.

COD.

COD.



TIPO-TYPE PE(S)6P..7000

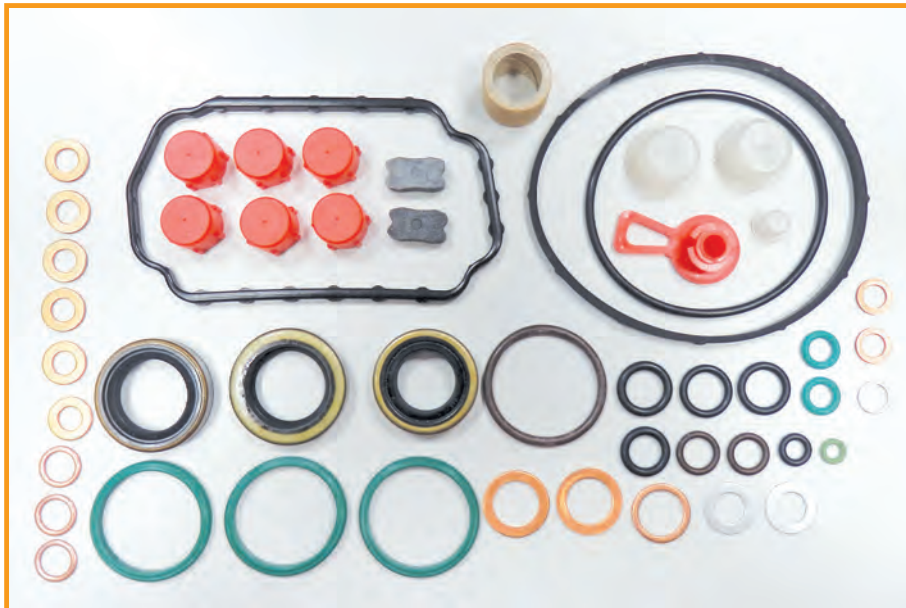

CODICE OMS 10-15-142

COD. Bh 1 467 010 059/2

COD.

COD.

COD.

Con 3 paraolio rettificati

TIPO-TYPE

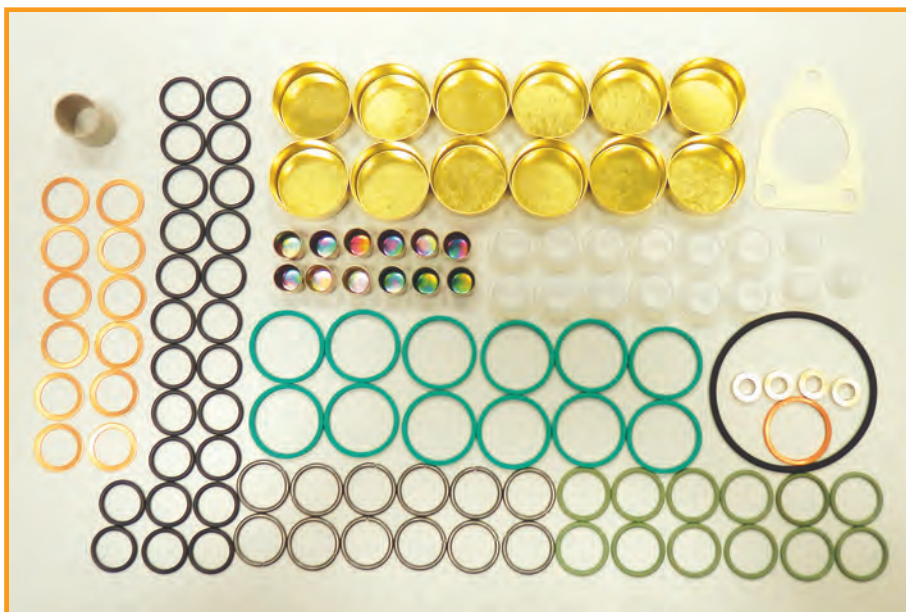

CODICE OMS 10-15-143

COD. Bh 2 417 010 023

COD.

COD.

COD.

TIPO-TYPE PE(S)12P..S1000/7804

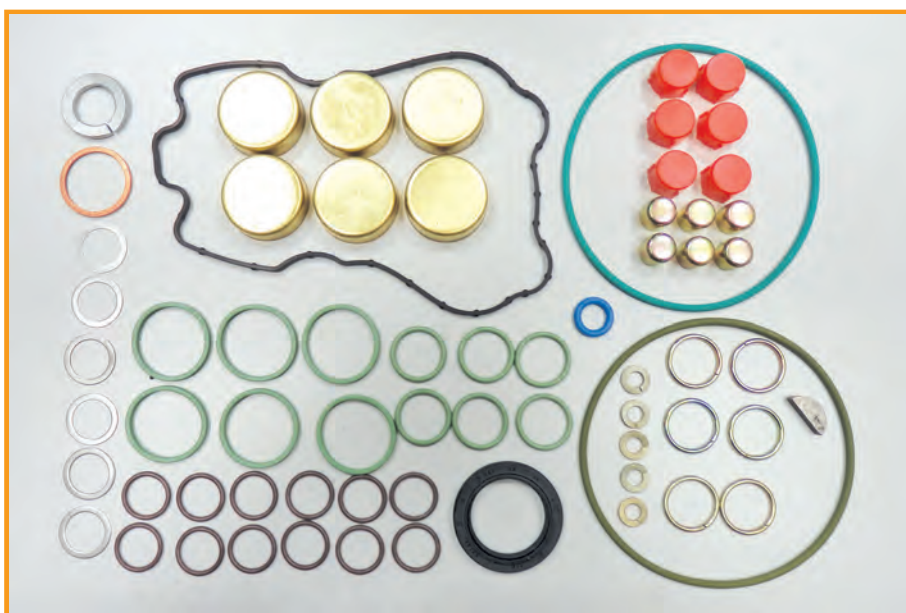

CODICE OMS 10-15-144

COD. Bh 9 401 087 559

COD.

COD.

COD.

Come 10-15-015 +
guarnizione 2 420 206 016

TIPO-TYPE PE(S)5/6P..7100/7200



CODICE OMS 10-15-144/1

COD. Bh 9 401 087 559

COD. _____

COD. _____

COD. _____

Versione Brasile

TIPO-TYPE

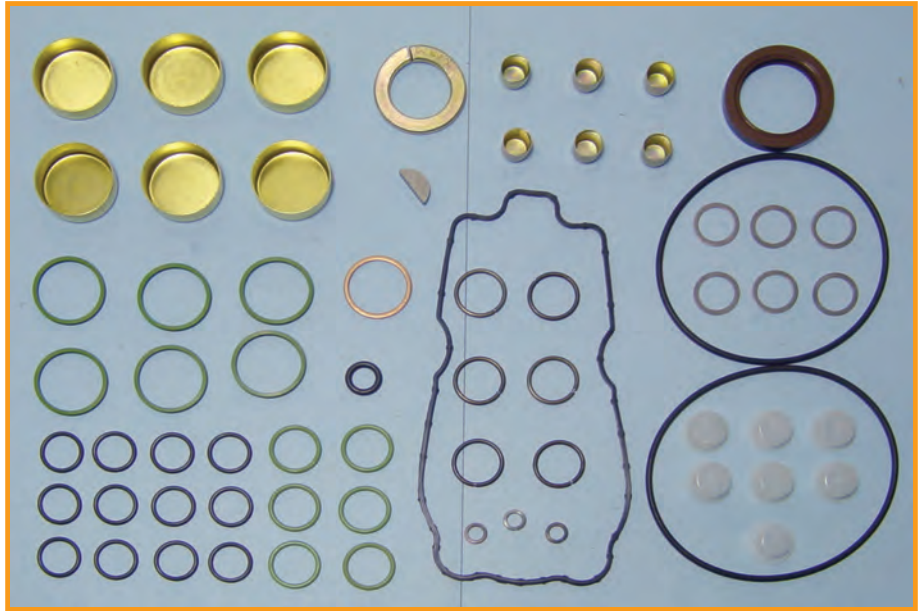

CODICE OMS 10-15-145

COD. _____

COD. _____

COD. _____

COD. _____

TIPO-TYPE PES 3A..D80..D85..D900

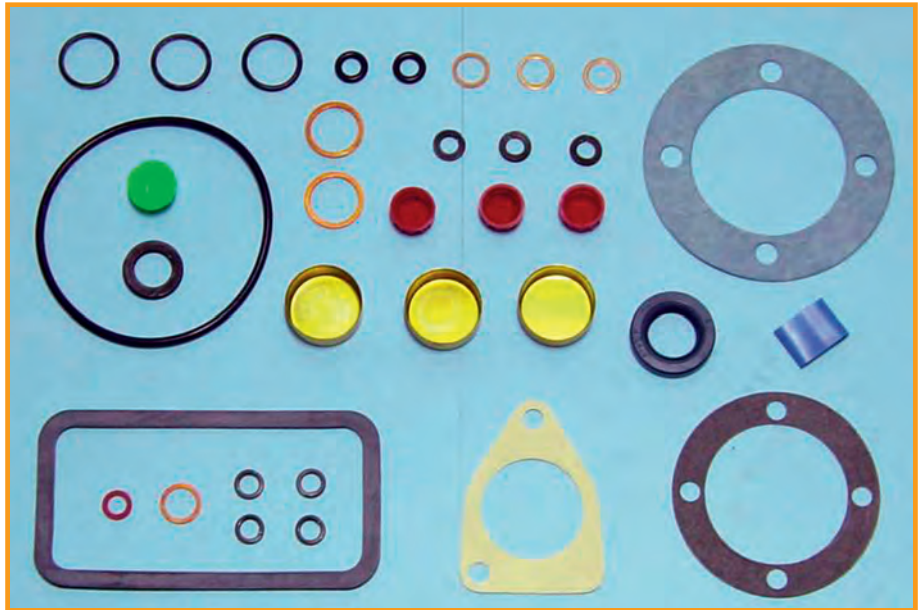

CODICE OMS 10-15-147

COD. Bh 1 467 010 517/

COD. _____

COD. _____

COD. _____

Con paraolio 17x28x7 rettificato

TIPO-TYPE EP/VE





CODICE OMS 10-15-148

COD. Bh 1 467 010 520/

COD. _____

COD. _____

COD. _____

Con paraolio 20x31x7 rettificato

TIPO-TYPE EP/VE



CODICE OMS 10-15-149

COD. Denso 096010-0300/

COD. _____

COD. _____

COD. _____

Con paraolio 20x30x7 rettificato

TIPO-TYPE EP/VE

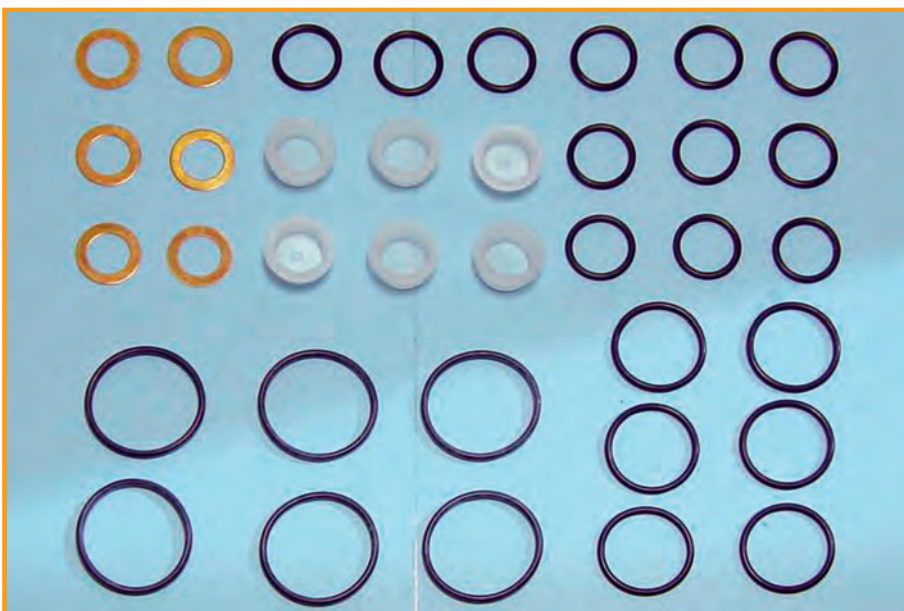

CODICE OMS 10-15-150

COD. _____

COD. _____

COD. _____

COD. _____

Kit Pompante

TIPO-TYPE PE 6P



CODICE OMS 10-15-153

COD. Bh 1 467 010 517/

COD.

COD.

COD.

Paraolio 17x28x7

TIPO-TYPE VE

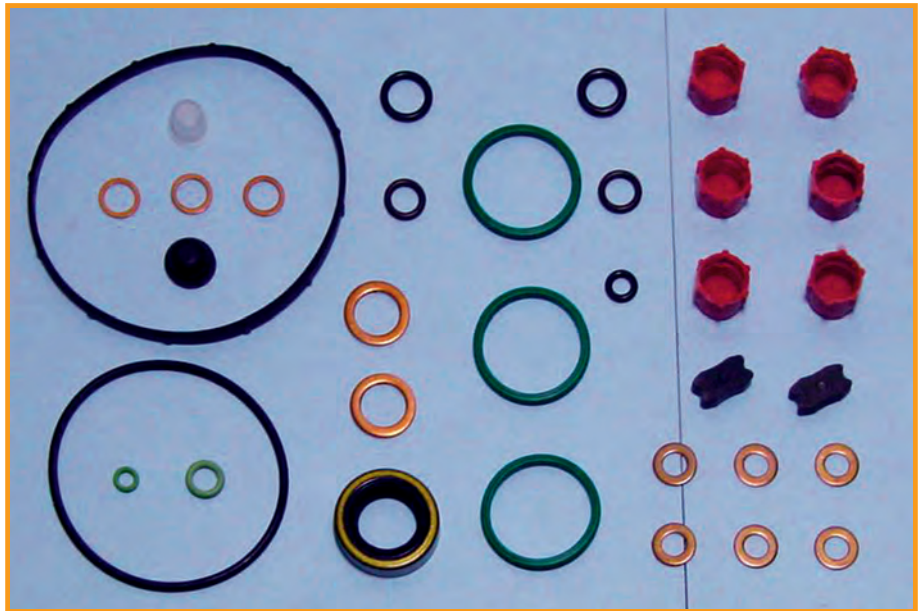

CODICE OMS 10-15-154

COD.

COD.

COD.

COD.

Type 3500-7000 for MACK

TIPO-TYPE PE..6P

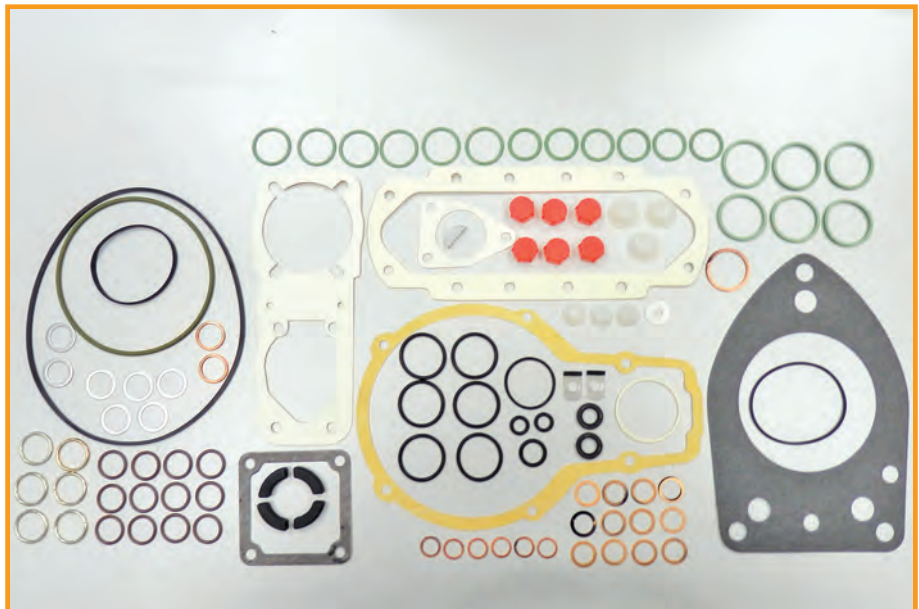

CODICE OMS 10-15-155

COD. Zexel GKIT KO-0010

COD.

COD.

COD.

TIPO-TYPE

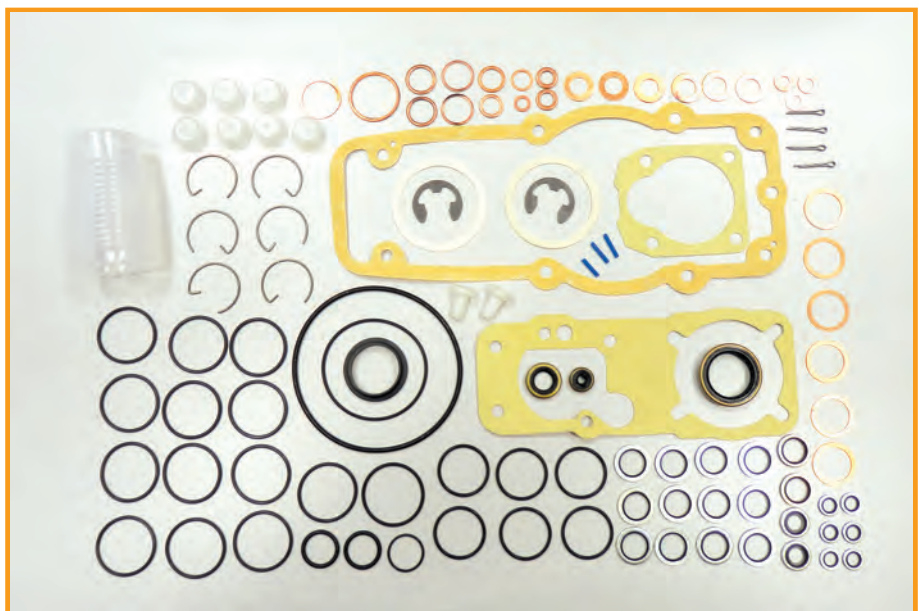



CODICE OMS 10-15-156

COD. Bh F 00N 350 001/1

COD.

COD.

COD.

TIPO-TYPE VP 29/30



CODICE OMS 10-15-156/1

COD. Bh F 00N 350 001

COD.

COD.

COD.

TIPO-TYPE VP 29/30

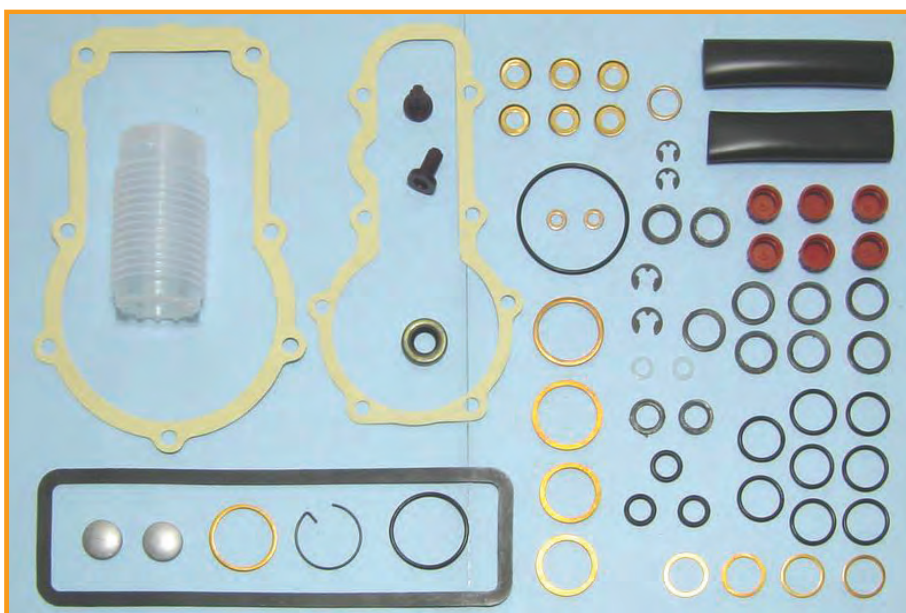

CODICE OMS 10-15-157

COD. Zexel GKIT IZ-0130

COD.

COD.

COD.

Con regolatore RLD e pompa FP-K

TIPO-TYPE PE..6 PES..6A



CODICE OMS 10-15-157/1

COD. Zexel GKIT IZ-0120

COD. Zexel GKIT IZ-0130

COD.

COD.

Con regolatore RLD e pompa FP-K

TIPO-TYPE PE..4 -PE..6

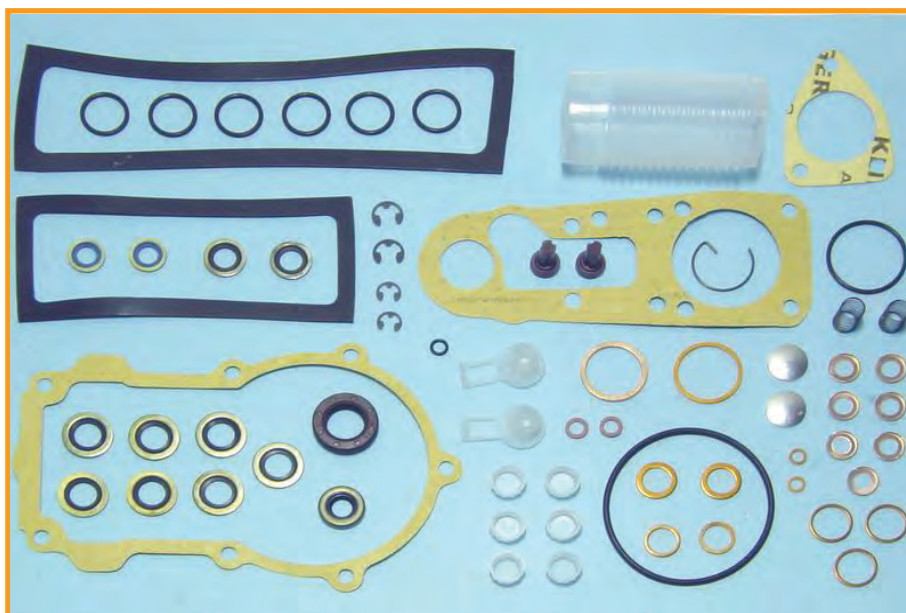

CODICE OMS 10-15-158

COD. Denso 190440-0380

COD.

COD.

COD.

TIPO-TYPE

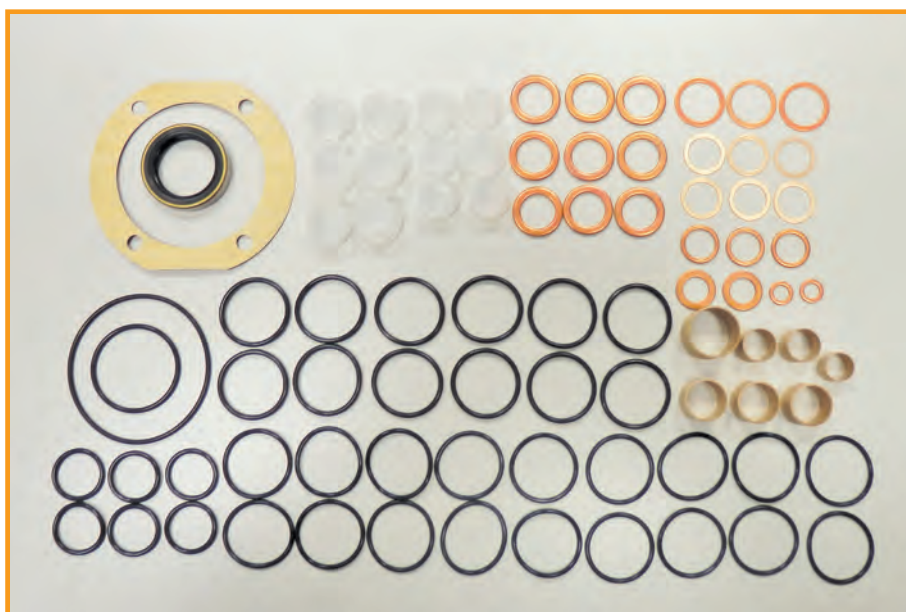

CODICE OMS 10-15-159

COD. Denso 190440-0390

COD.

COD.

COD.

TIPO-TYPE

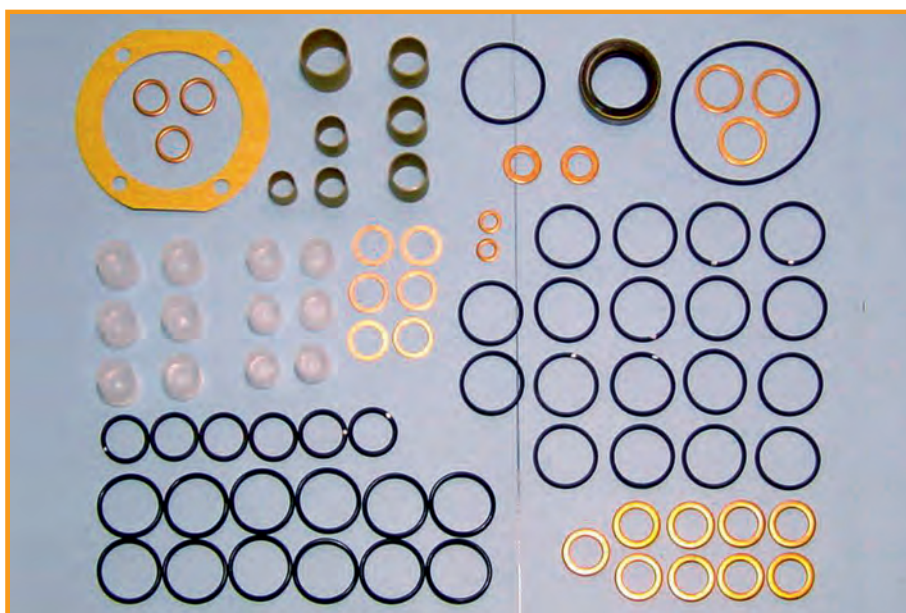



CODICE OMS 10-15-160

COD. GK 204

COD.

COD.

COD.

TIPO-TYPE RQ / RQV

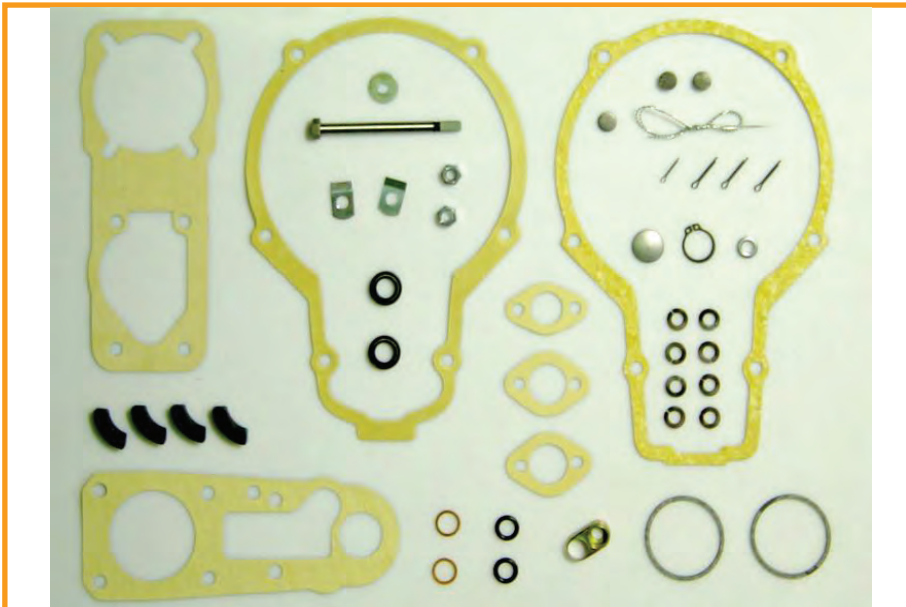

CODICE OMS 10-15-160/1

COD. GK 204/1

COD.

COD.

COD.

TIPO-TYPE RQ / RQV

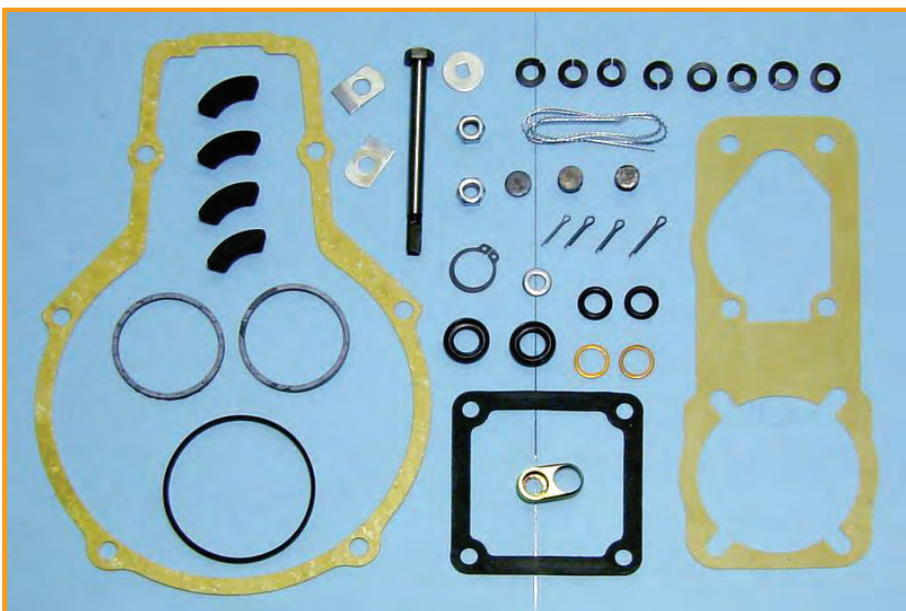

CODICE OMS 10-15-160/2

COD. GK 204/2

COD.

COD.

COD.

TIPO-TYPE RQ / RQV..K.S. MACK



CODICE OMS 10-15-161

COD. DGK 128

COD.

COD.

COD.

TIPO-TYPE

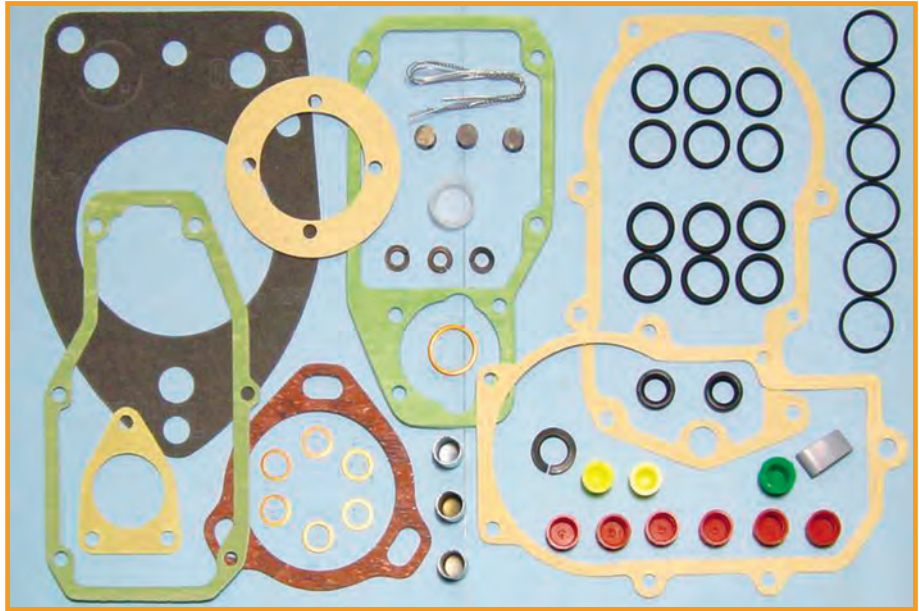

CODICE OMS 10-15-162

COD. GK 304

COD.

COD.

COD.

TIPO-TYPE

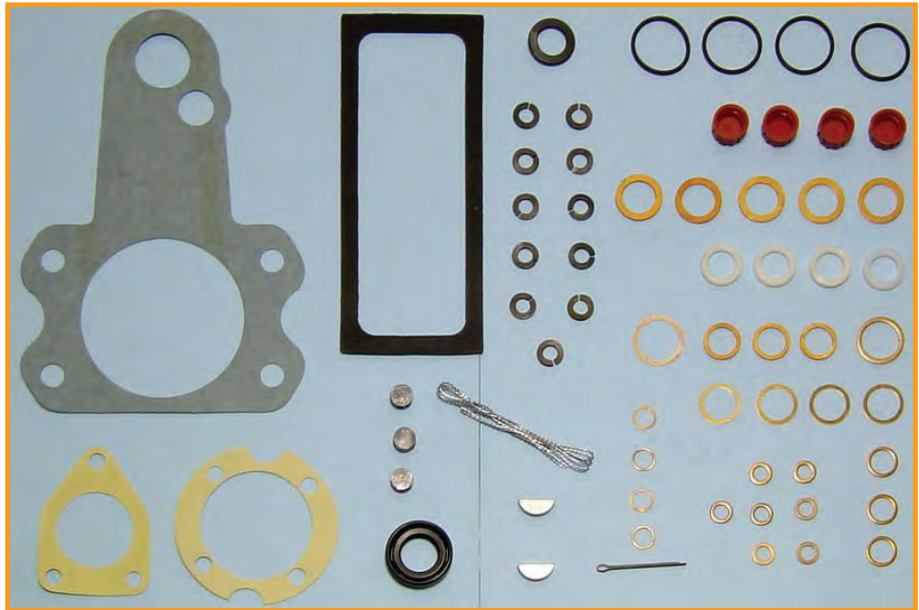

CODICE OMS 10-15-163

COD. GK 203

COD.

COD.

COD.

TIPO-TYPE

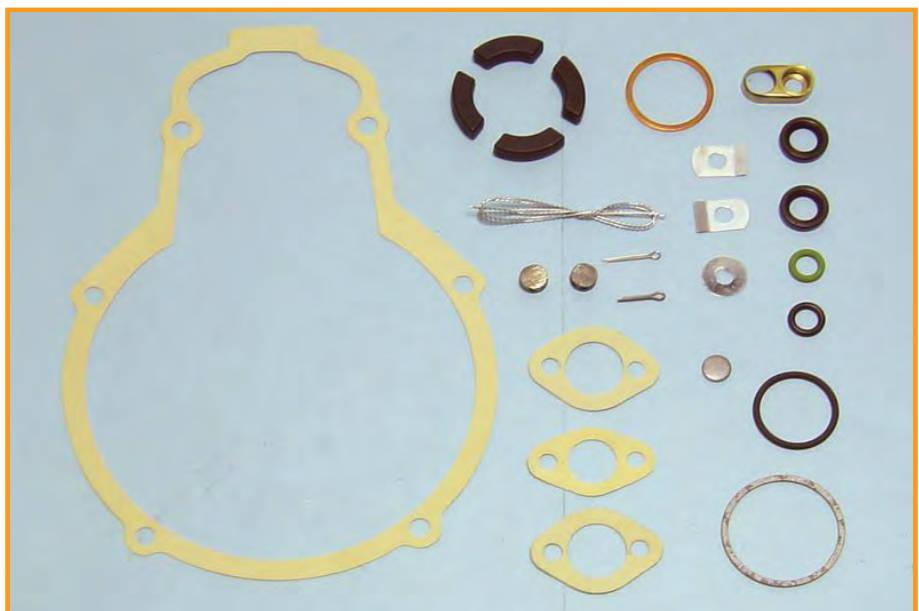

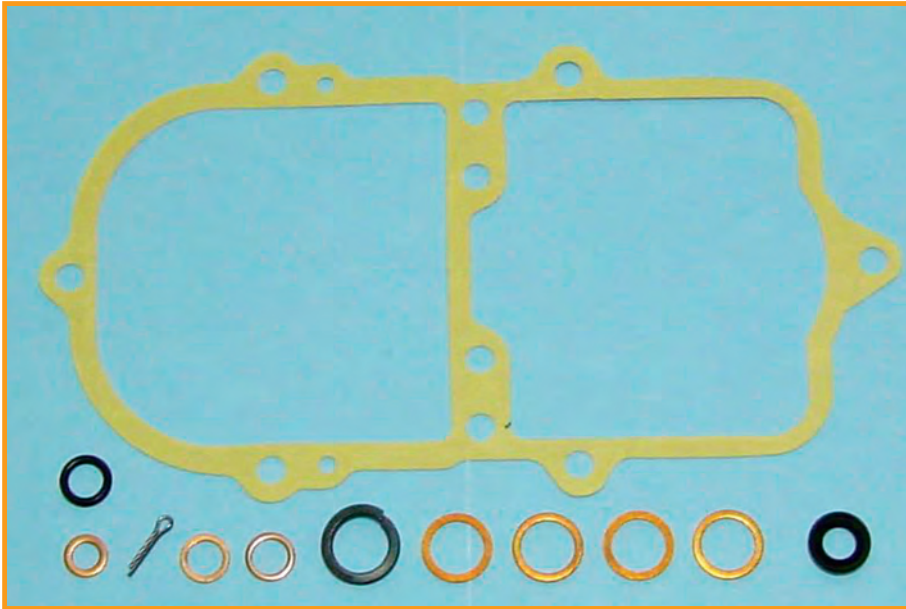

CODICE OMS 10-15-164

COD. Denso 190890-0050

COD.

COD.

COD.

TIPO-TYPE



CODICE OMS 10-15-165

COD. GKIT IZ-0120

COD.

COD.

COD.

TIPO-TYPE

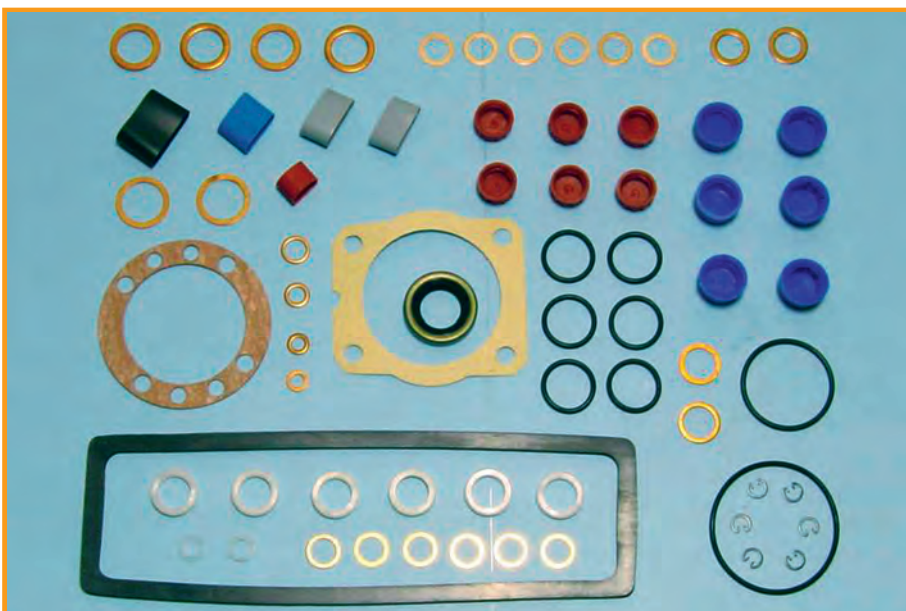

CODICE OMS 10-15-166

COD. Denso 190440-0340

COD.

COD.

COD.

TIPO-TYPE



CODICE OMS 10-15-167

COD. Bh 2 427 010 001

COD.

COD.

COD.

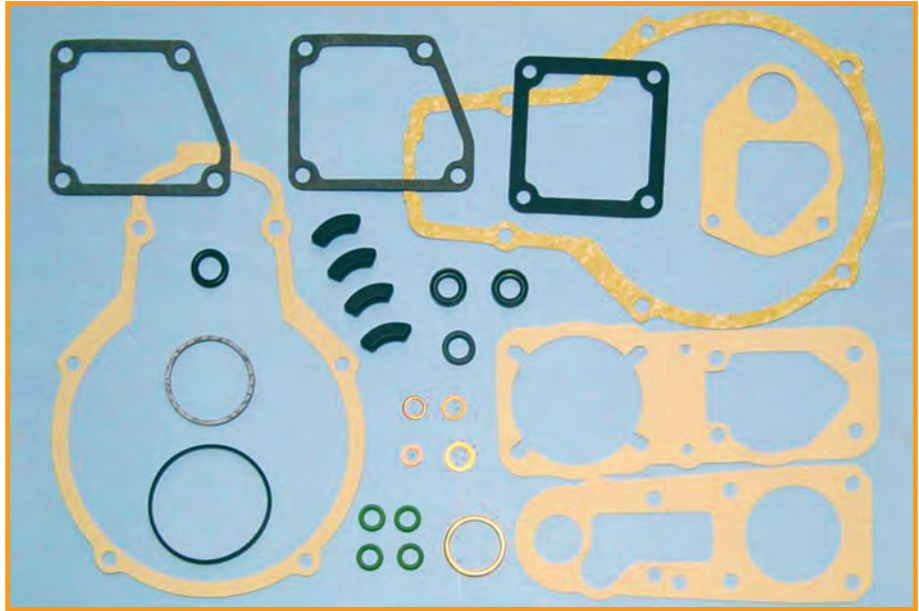

TIPO-TYPE RQV / RQV..K

CODICE OMS 10-15-168

COD.

COD.

COD.

COD.



TIPO-TYPE Zexel

CODICE OMS 10-15-169

COD. Bh F 000 421 064

COD.

COD.

COD.



TIPO-TYPE

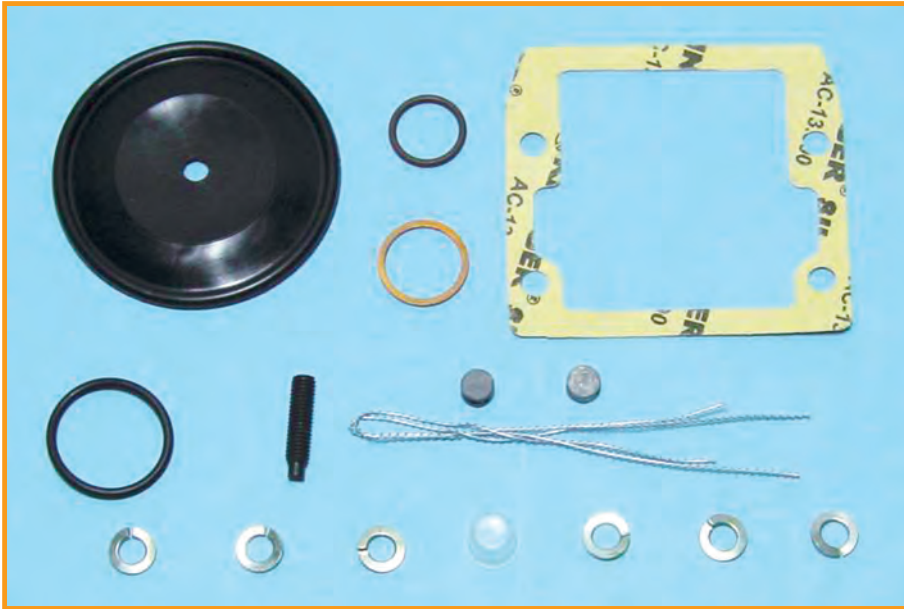

CODICE OMS 10-15-170

COD. _____
COD. _____
COD. _____
COD. _____

Smoke limit - Mercedes - Iveco
Membrana con foro Ø 6 mm

TIPO-TYPE LDA

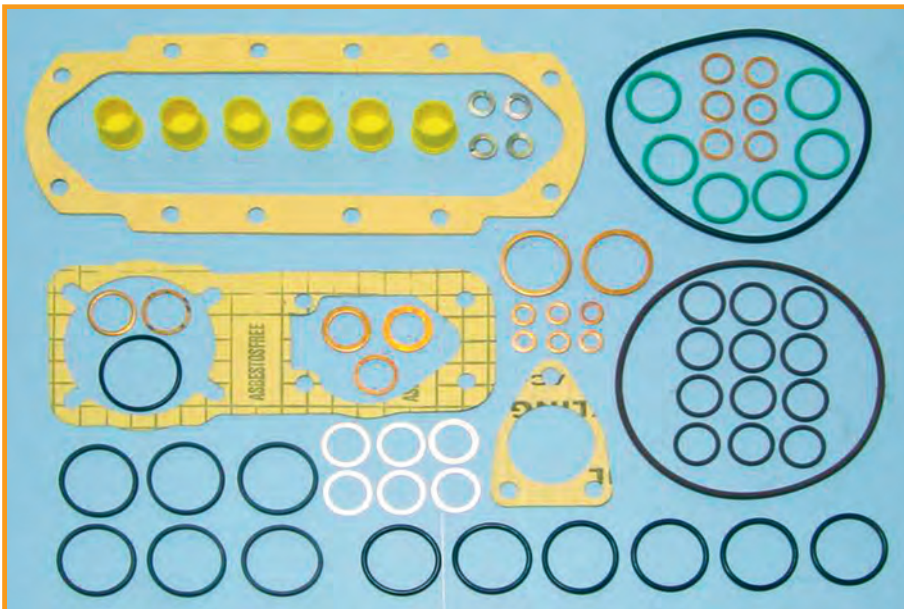

CODICE OMS 10-15-171

COD. DGK 117
COD. _____
COD. _____
COD. _____

for MACK

TIPO-TYPE 6P..S.6000

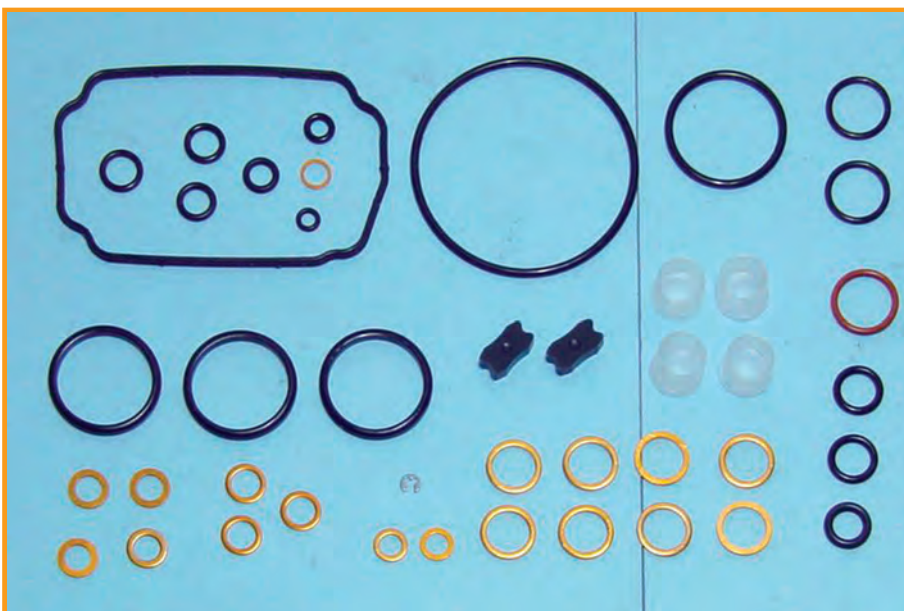

CODICE OMS 10-15-172

COD. Denso 096010-0111
COD. _____
COD. _____
COD. _____

TIPO-TYPE EP-VE Denso



CODICE OMS 10-15-173

COD. Denso 096010-0630
 COD.
 COD.
 COD.

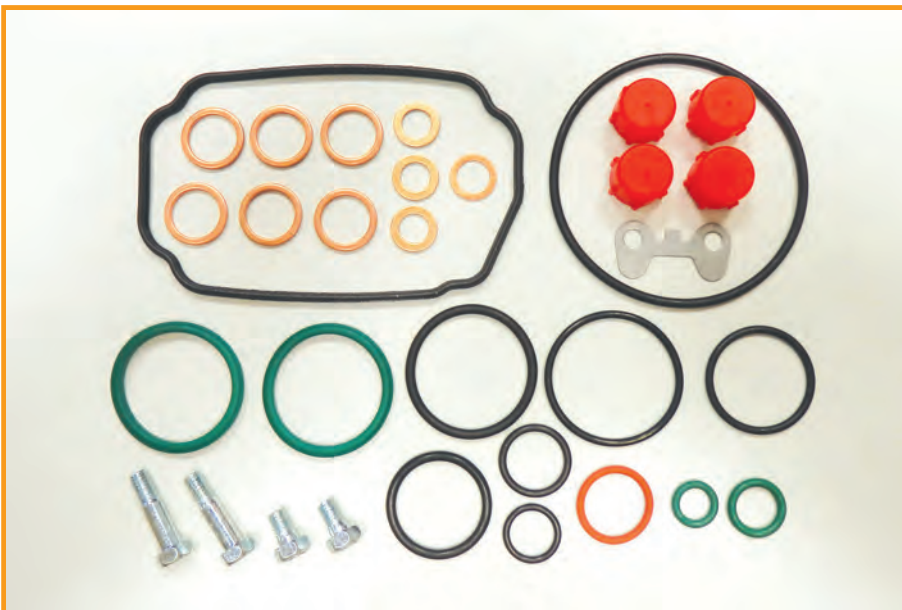

TIPO-TYPE Pompa ECD-V3 Denso

CODICE OMS 10-15-174

COD. Bh F 002 A10 615 (3B3)
 COD.
 COD.
 COD.

(Pos. 116/2)

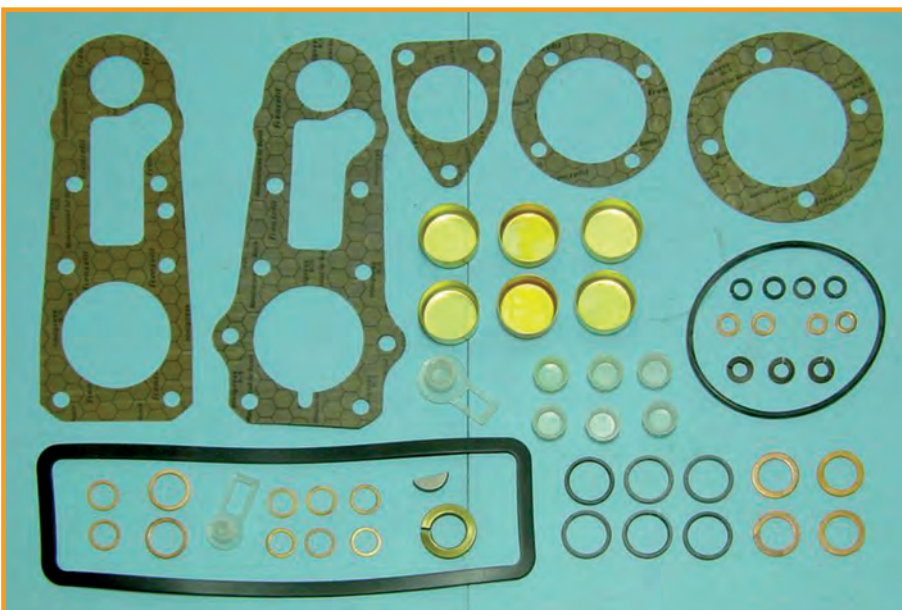

TIPO-TYPE PE(S) 6A..D..S3000

CODICE OMS 10-15-175

COD. Bh 2 427 010 049
 COD.
 COD.
 COD.



TIPO-TYPE RQ,RQV.PA.MW

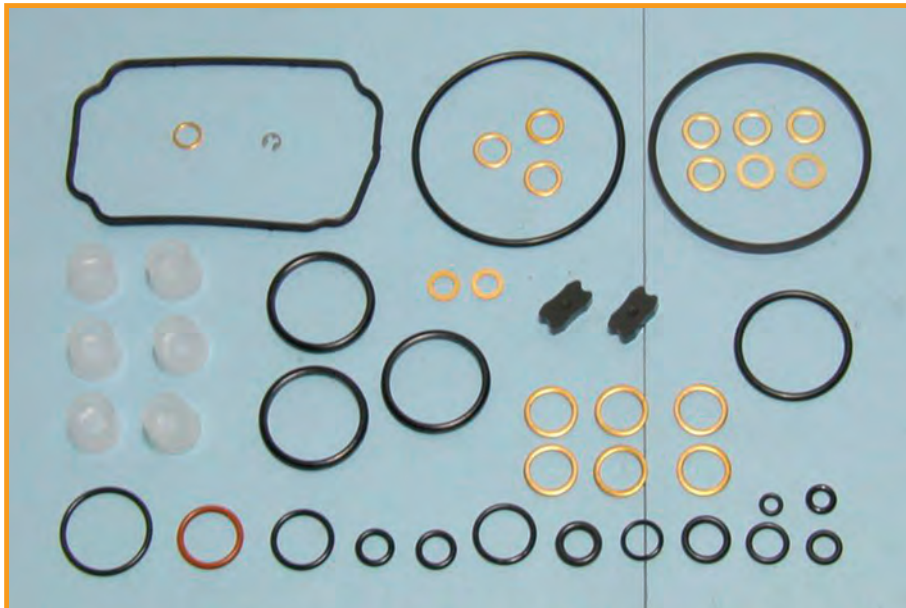

CODICE OMS 10-15-176

COD. Denso 096010-0551

COD. _____

COD. _____

COD. _____

TIPO-TYPE EP/VE

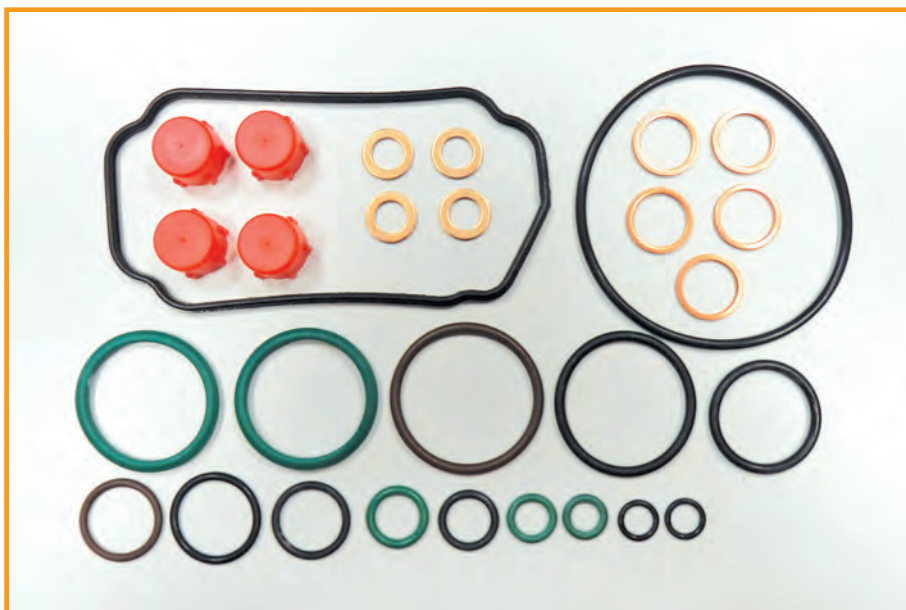

CODICE OMS 10-15-177

COD. Denso 096010-0780

COD. _____

COD. _____

COD. _____

TIPO-TYPE EP/VE

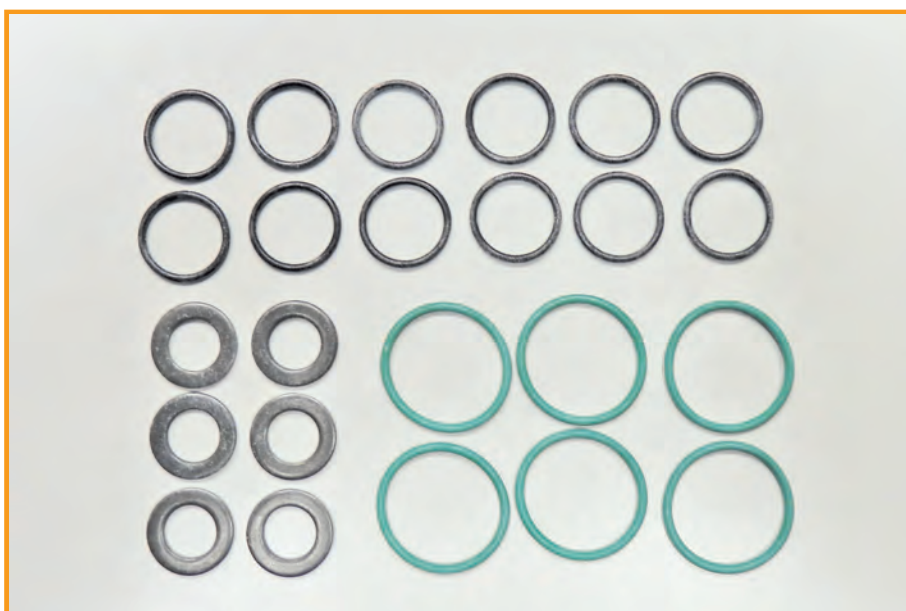

CODICE OMS 10-15-178

COD. _____

COD. _____

COD. _____

COD. _____

MACK 6 cilindri

TIPO-TYPE



CODICE OMS 10-15-179

COD. Bh 9 461 080 509

COD.

COD.

COD.

10-15-179/1 A PAG. 84

TIPO-TYPE

EP/VE..F..

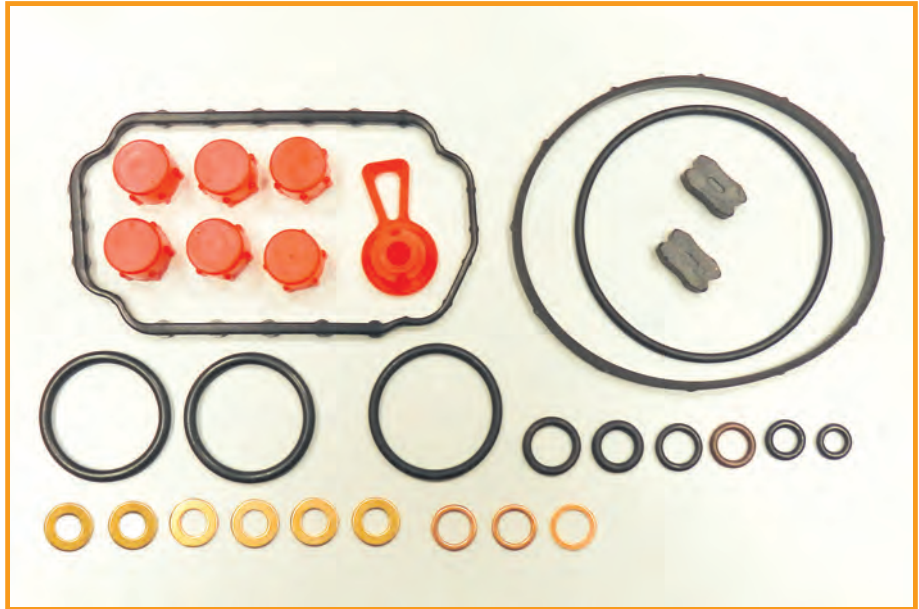

CODICE OMS 10-15-180

COD. Bh 9 401 087 818

COD.

COD.

COD.

Scania Volvo in Brasile
Paraolio 25x35x7

TIPO-TYPE

PE(S)6P..3000

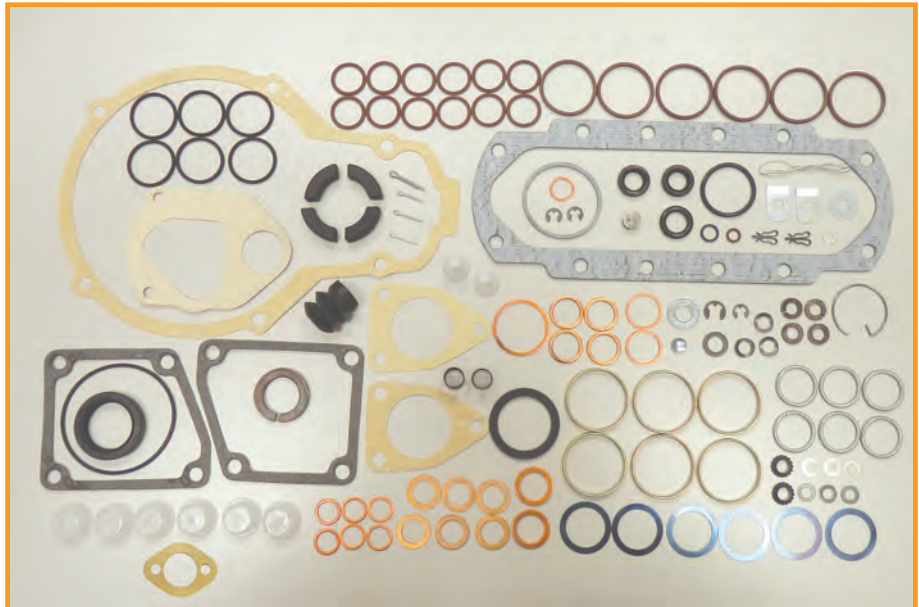

CODICE OMS 10-15-180/1

COD. Bh 9 401 087 818

COD.

COD.

COD.

Versione Brasile

TIPO-TYPE

PE8P..7100

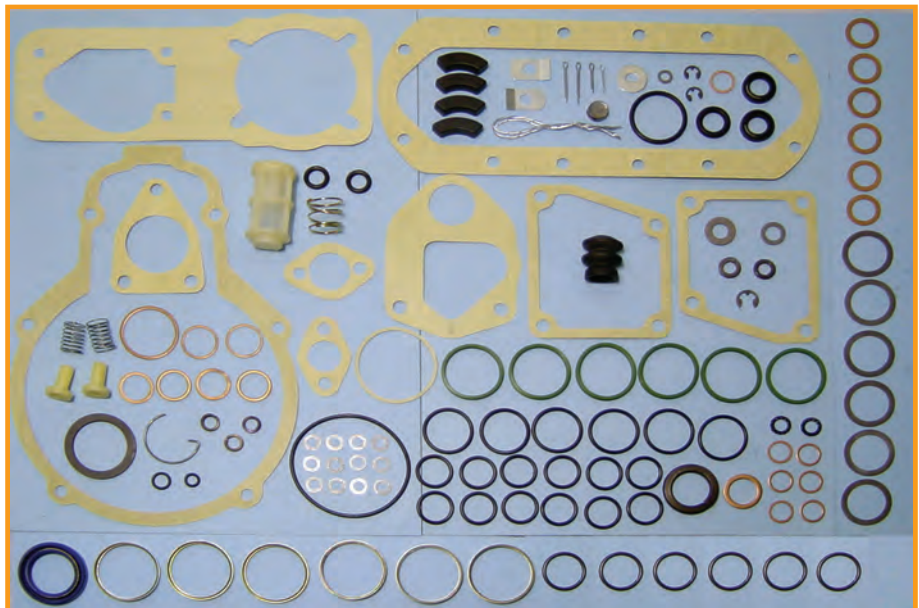

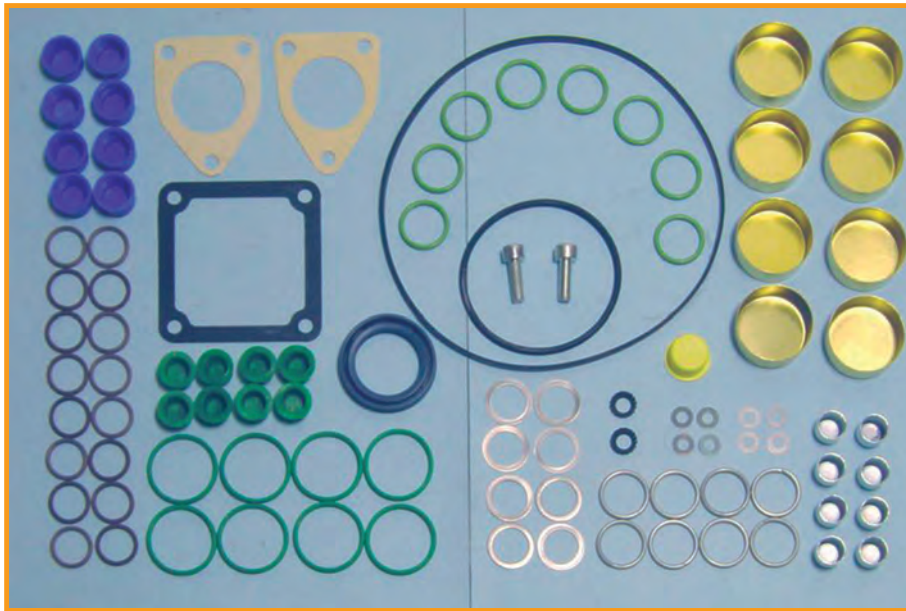

CODICE OMS 10-15-181

COD. Bh 9 401 087 558

COD.

COD.

COD.

TIPO-TYPE PE8P..7100

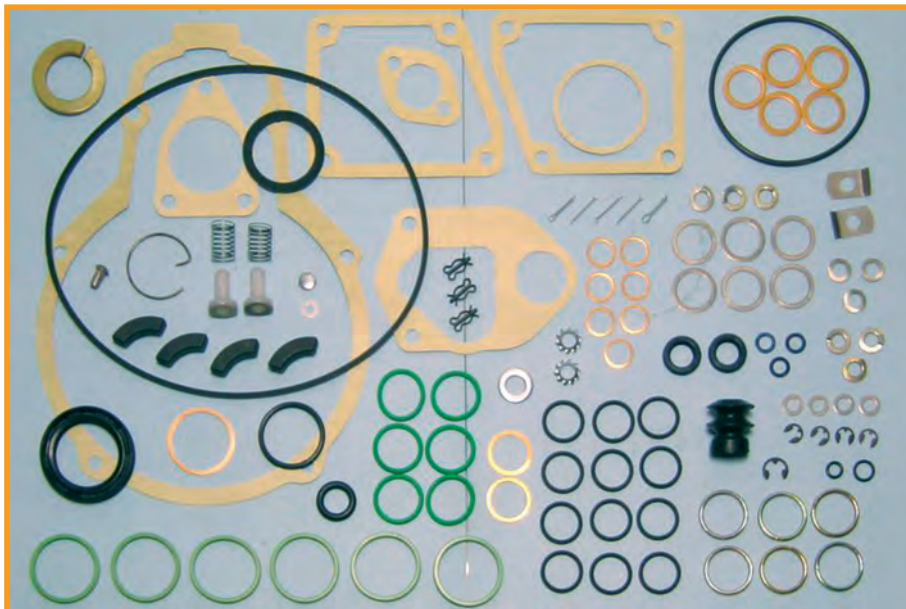

CODICE OMS 10-15-182

COD. Bh 9 401 087 819

COD.

COD.

COD.

Scania Volvo in Brasile
Paraolio 30x42x6

TIPO-TYPE PE(S)6P..7000

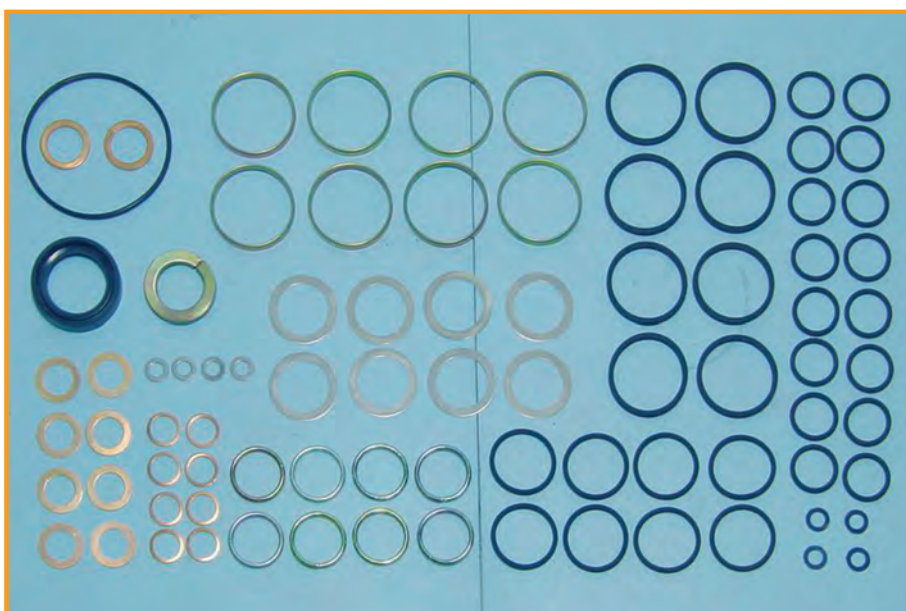

CODICE OMS 10-15-183

COD. Bh 9 401 087 019

COD.

COD.

COD.

Paraolio 25x35x7

TIPO-TYPE PE8P..7000-7100



CODICE OMS 10-15-184

COD. Bh 9 401 087 182

COD.

COD.

COD.

Paraolio 30x42x6

TIPO-TYPE PE8P..7000



CODICE OMS 10-15-185

COD. Bh 9 421 081 182

COD.

COD.

COD.

TIPO-TYPE RQV Kit



CODICE OMS 10-15-186

COD. Bh 9 401 087 817

COD.

COD.

COD.

TIPO-TYPE RQV Kit

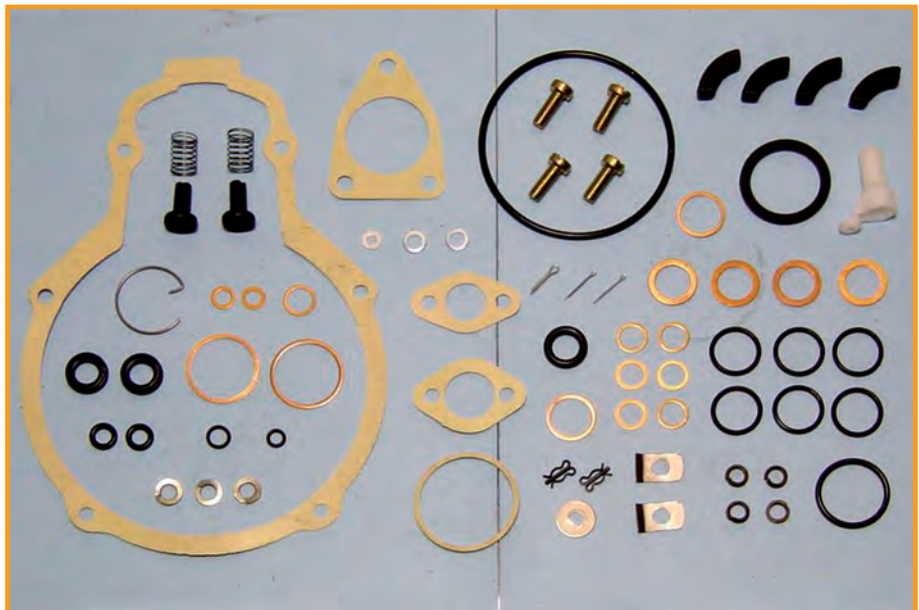

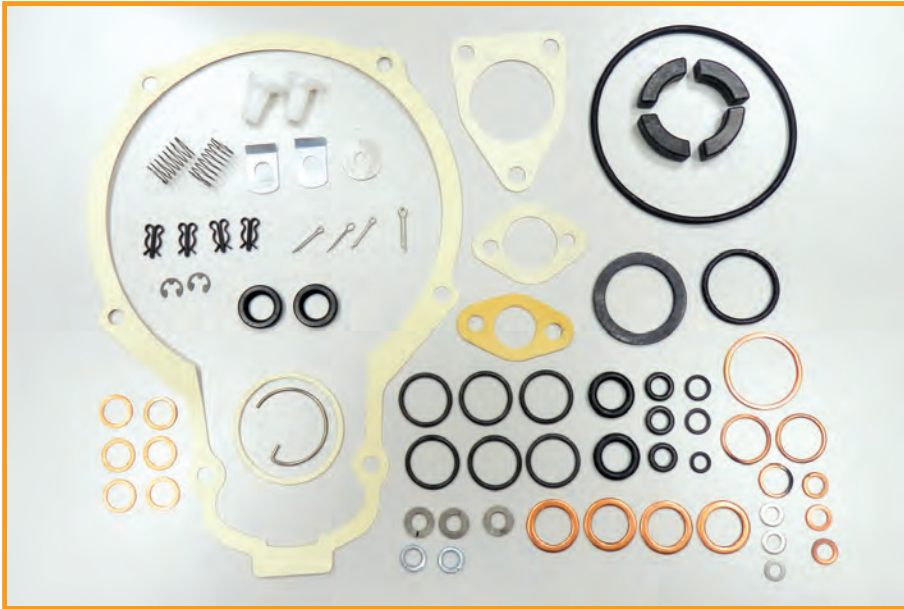

CODICE OMS 10-15-186/1

COD. Bh 9 401 087 817

COD. _____

COD. _____

COD. _____

Versione Brasile

TIPO-TYPE RQV Kit

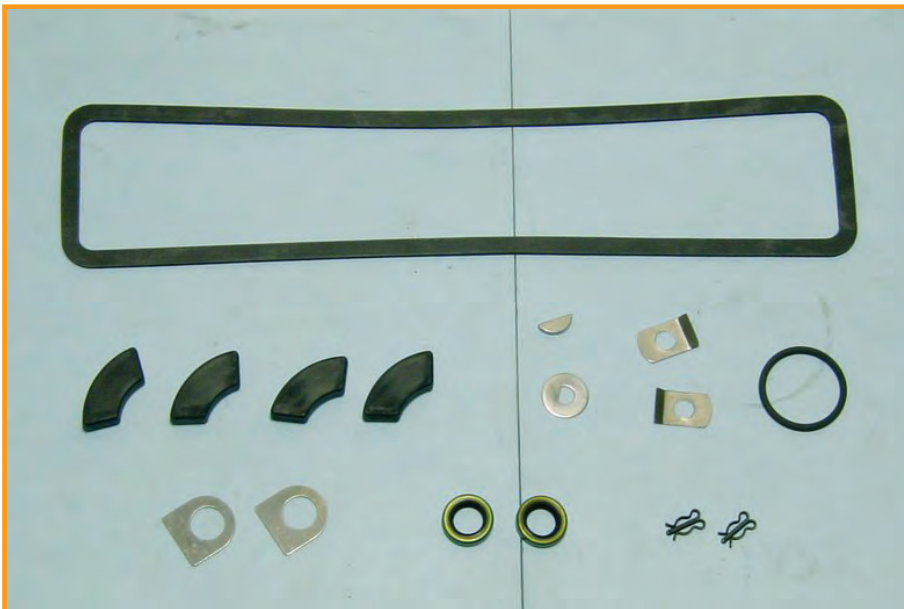

CODICE OMS 10-15-187

COD. Bh 9 421 081 231

COD. _____

COD. _____

COD. _____

Con guarnizione coperchio 8 cilindri

TIPO-TYPE PE8P..7000-7100

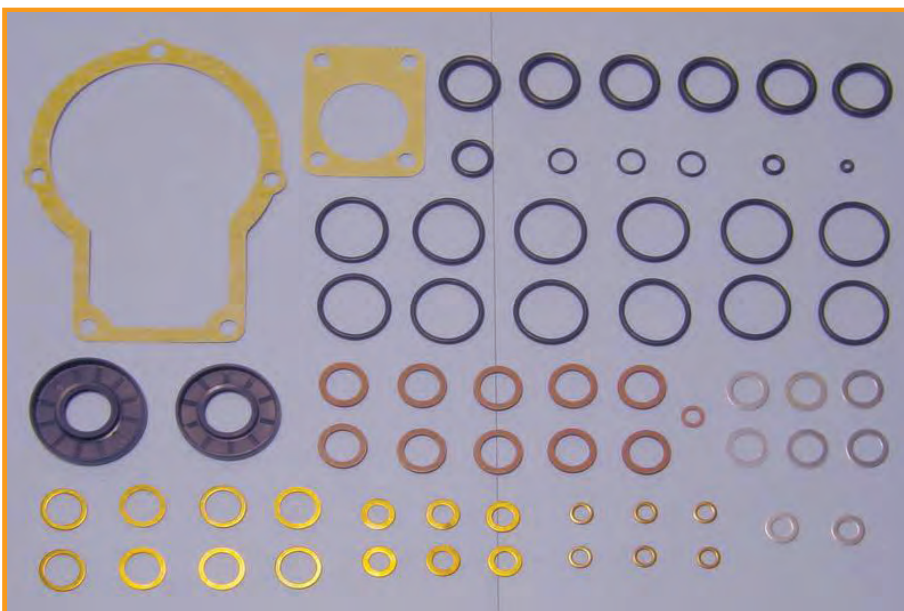

CODICE OMS 10-15-188

COD. SIGMA CMX 6D

COD. _____

COD. _____

COD. _____

TIPO-TYPE



CODICE OMS 10-15-189

COD. GK RSUV - 2500

COD.

COD.

COD.

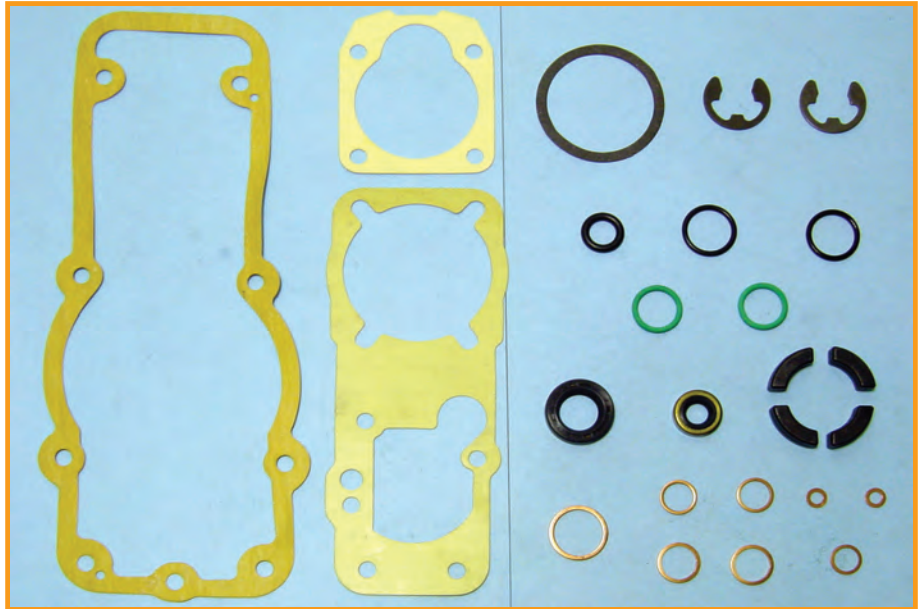

TIPO-TYPE

CODICE OMS 10-15-190

COD. Denso 190440-0360

COD.

COD.

COD.

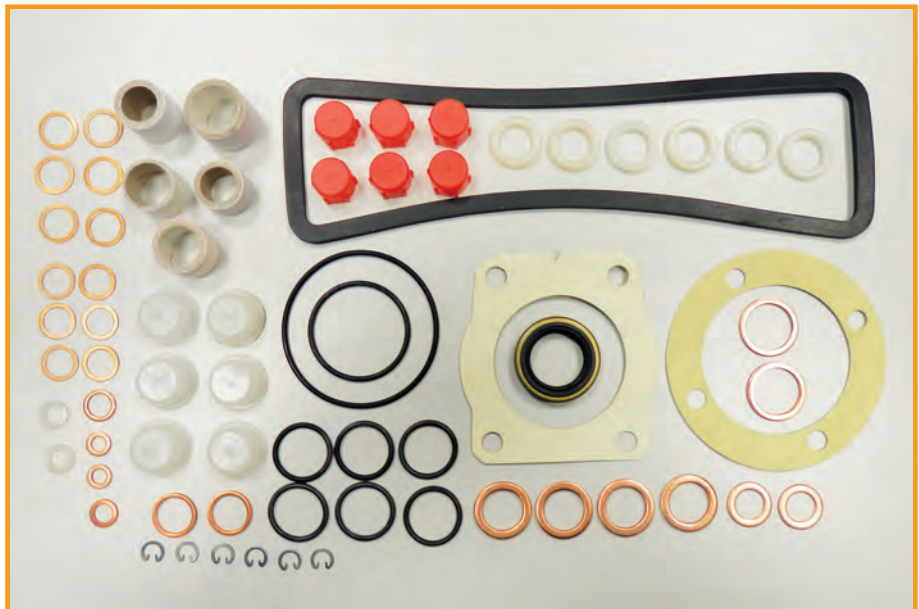

TIPO-TYPE

CODICE OMS 10-15-191

COD. 190890-0720

COD.

COD.

COD.

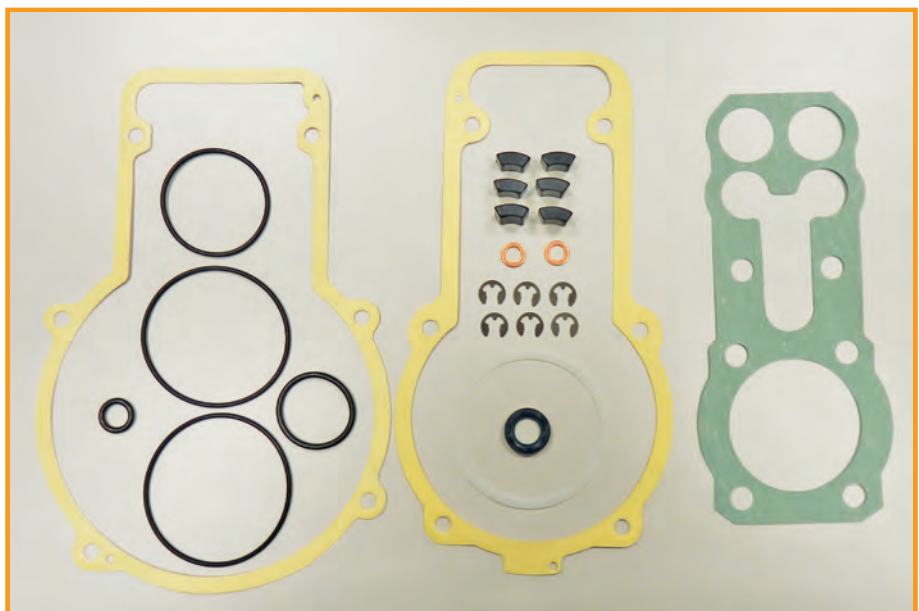

TIPO-TYPE



CODICE OMS 10-15-192

COD. Bh 1 417 010 020

COD.

COD.

COD.

TIPO-TYPE PE(S)4MW..RS/RQV

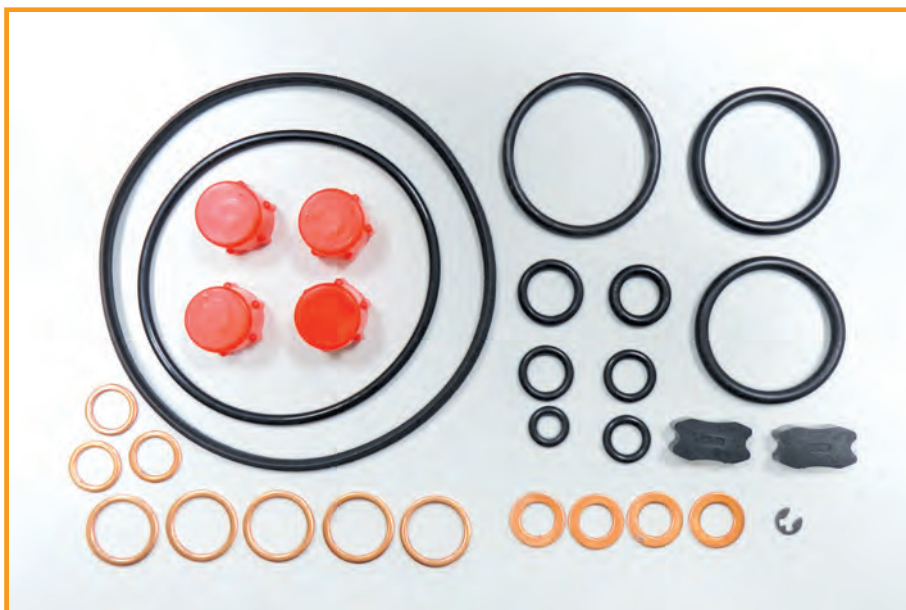

CODICE OMS 10-15-193

COD. Denso 096010-0010

COD.

COD.

COD.

10-15-193/1 A PAG. 96

TIPO-TYPE

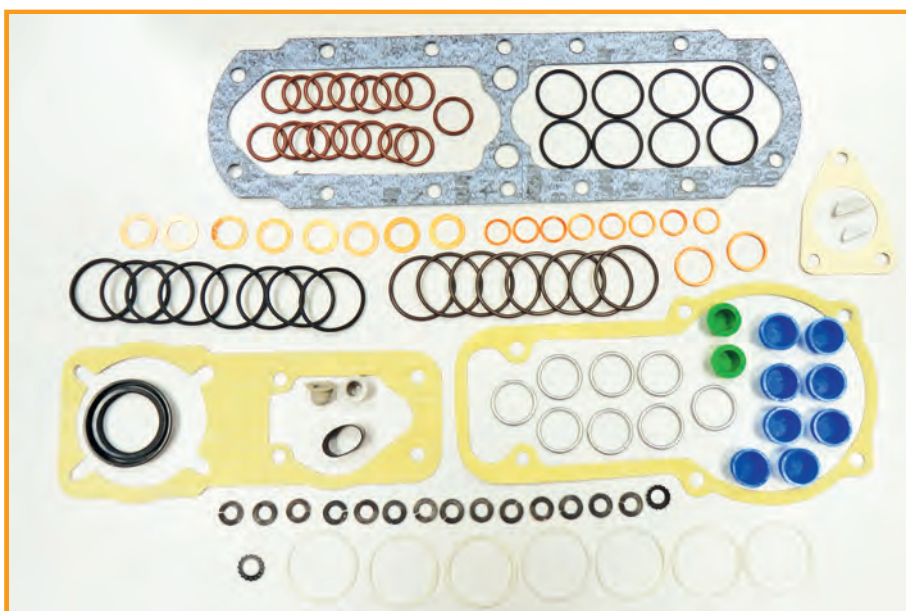

CODICE OMS 10-15-194

COD. 71343-2

COD.

COD.

COD.

TIPO-TYPE PE8P 29MM



CODICE OMS 10-15-195

COD. Denso 097490-0010
 Versione alleggerita senza raccordo
 COD. Small version without joint
 COD.
 COD.



TIPO-TYPE

CODICE OMS 10-15-195/1

COD. Denso 097490-0010
 kit completo
 complete kit
 COD.
 COD.



TIPO-TYPE

CODICE OMS 10-15-196

COD. Denso 294009-0030
 COD.
 COD.
 COD.



TIPO-TYPE

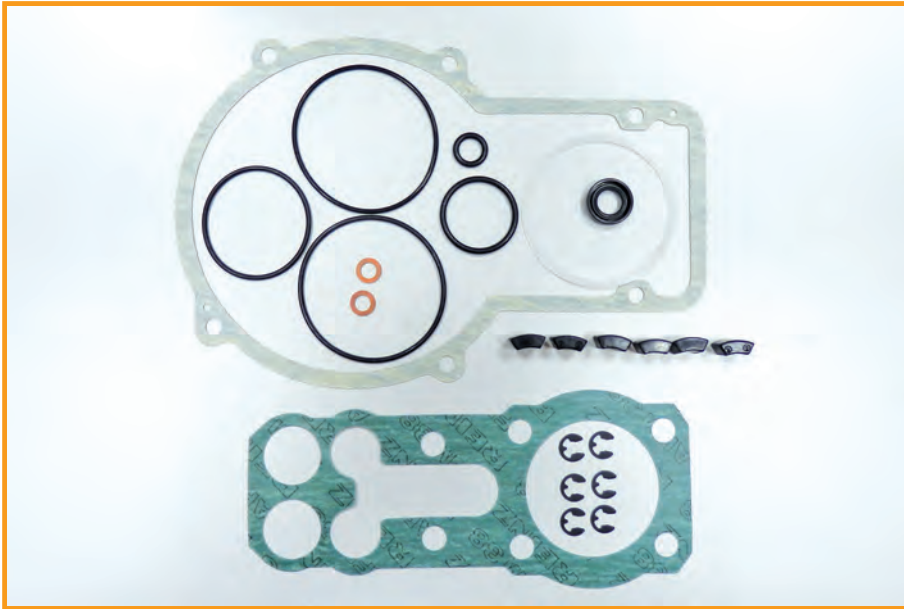

CODICE OMS 10-15-198

COD. 190890-0730

COD.

COD.

COD.

TIPO-TYPE



CODICE OMS 10-15-199

COD. 096010-0540A

COD.

COD.

COD.

TIPO-TYPE



CODICE OMS 10-15-200

COD. 146600-2420

COD. Bh 9 461 610 430

COD.

COD.

TIPO-TYPE



CODICE OMS 10-15-201

COD. Bh 9 421 082 400

COD.

COD.

COD.



TIPO-TYPE

CODICE OMS 10-15-202

COD. Denso 190440-0320

COD.

COD.

COD.

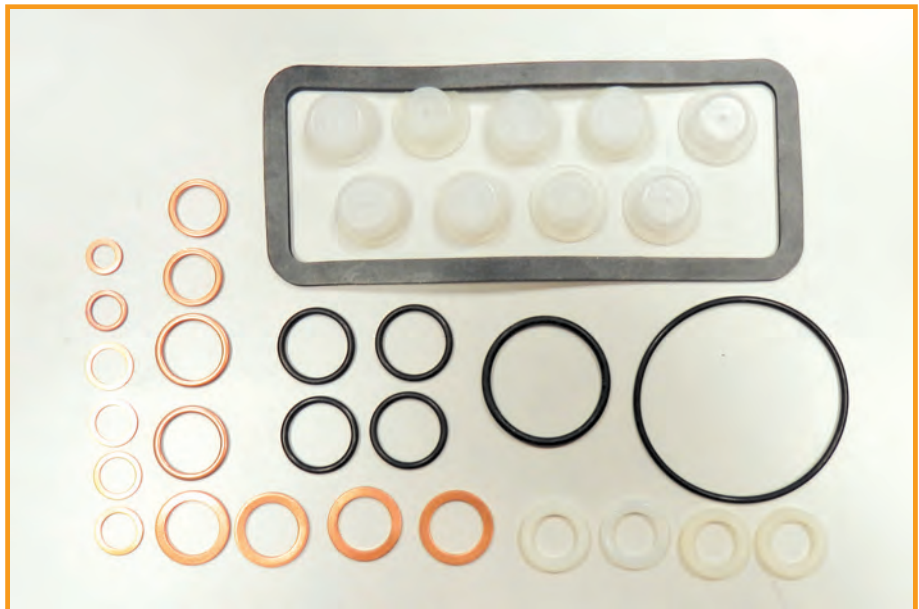

TIPO-TYPE

CODICE OMS 10-15-203

COD. GK-T6-AD-0900

COD.

COD.

COD.

Versione speciale

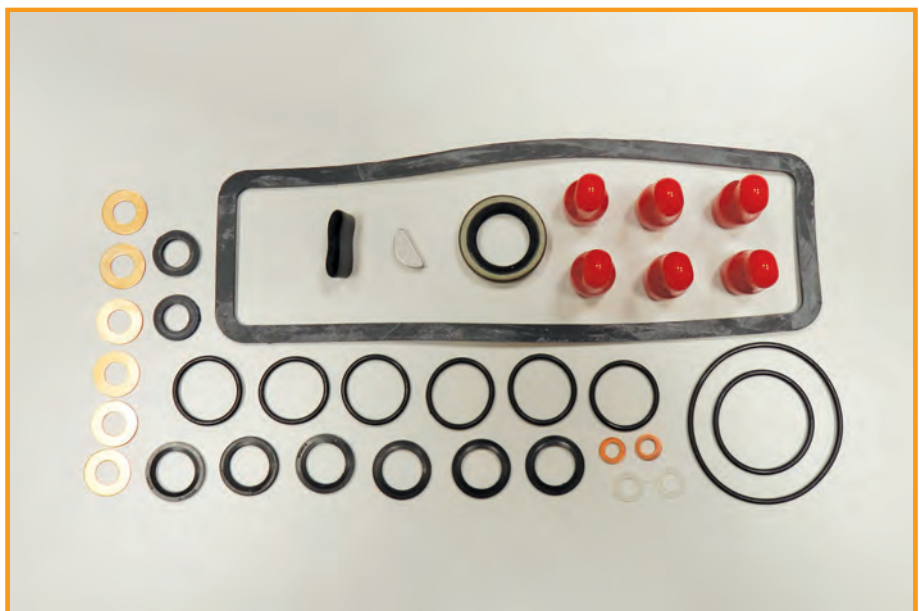

TIPO-TYPE

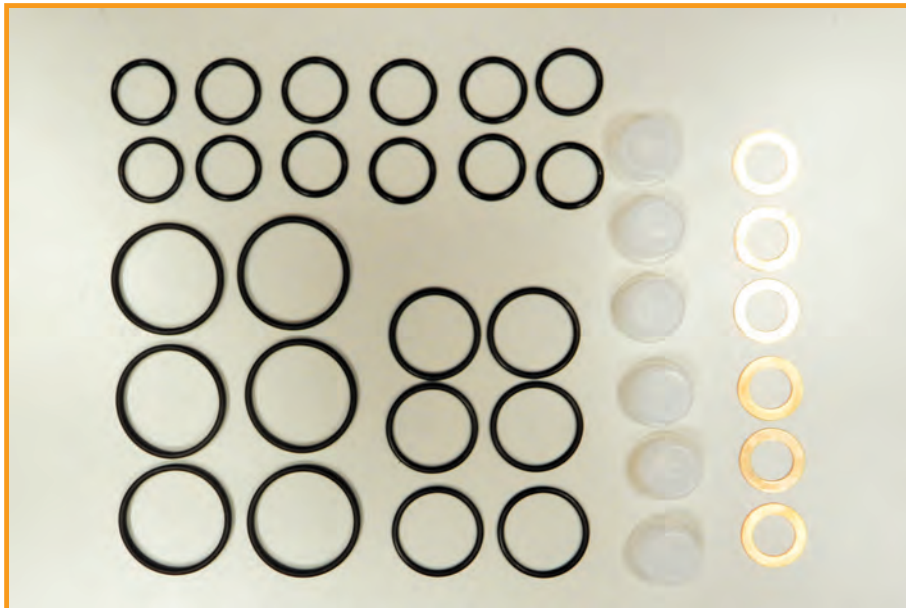

CODICE OMS 10-15-204

COD. K664002/5-L116

COD.

COD.

COD.

Versione speciale

TIPO-TYPE



CODICE OMS 10-15-205

COD.

COD.

COD.

COD.

Versione speciale

TIPO-TYPE



CODICE OMS 10-15-206

COD. VI - Mack - III

COD.

COD.

COD.

TIPO-TYPE



CODICE OMS 10-15-207

COD. 294009-0050

COD. 294009-0051

COD.

COD.



TIPO-TYPE C/R DENSO HP4

CODICE OMS 10-15-208

COD. Denso 094040-0010

COD.

COD.

COD.

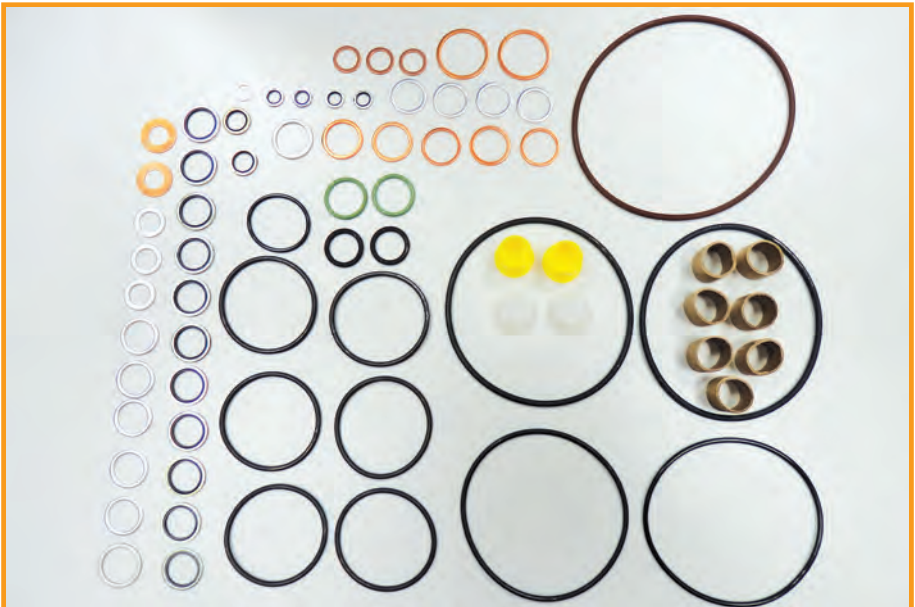

TIPO-TYPE C/R DENSO HP0

CODICE OMS 10-15-209

COD. Denso 094040-0030

COD.

COD.

COD.

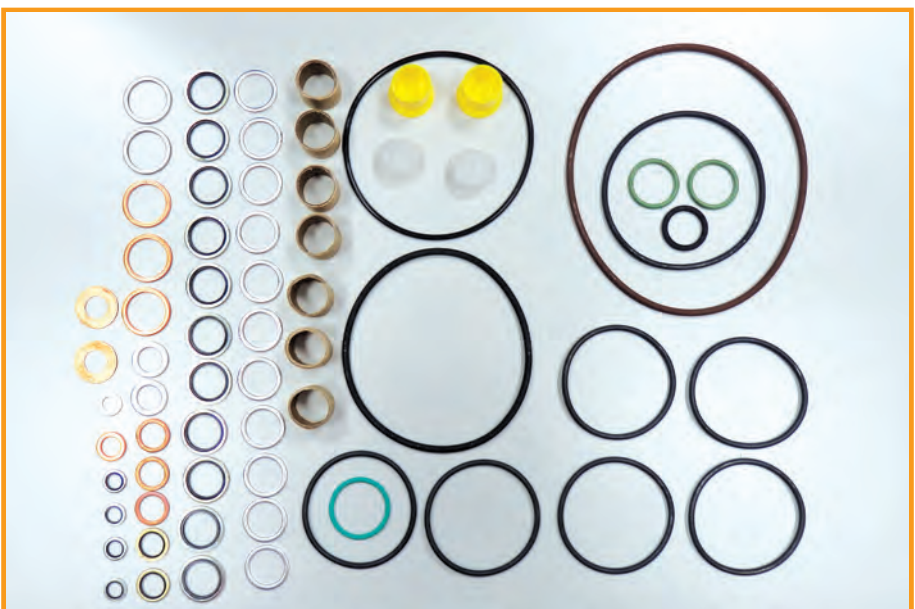

TIPO-TYPE C/R DENSO HP0

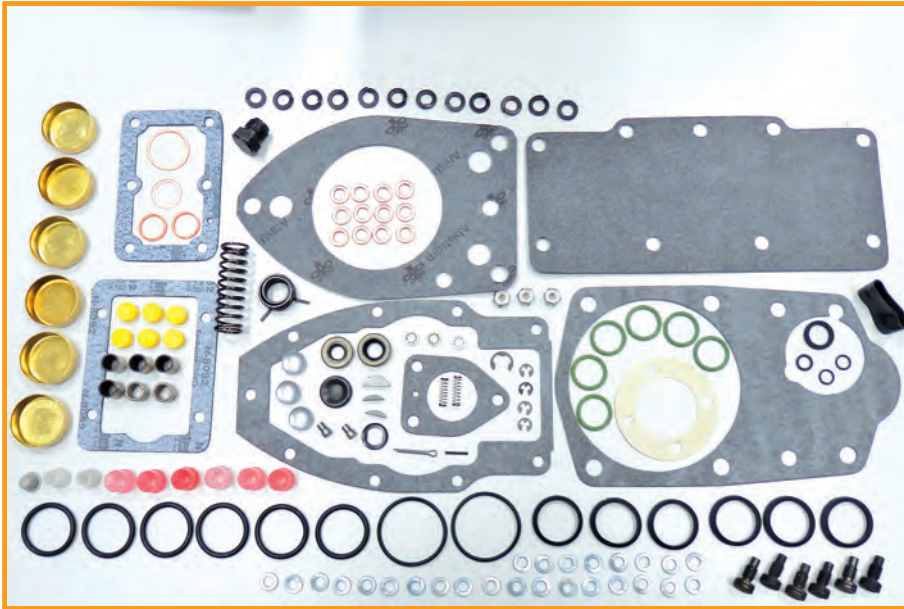

CODICE OMS 10-15-210

COD. AMBAC

COD.

COD.

COD.

TIPO-TYPE APE 6BB-GVB300



CODICE OMS 10-15-211

COD. GM INJECTOR FILTER KIT

COD.

COD.

COD.

TIPO-TYPE

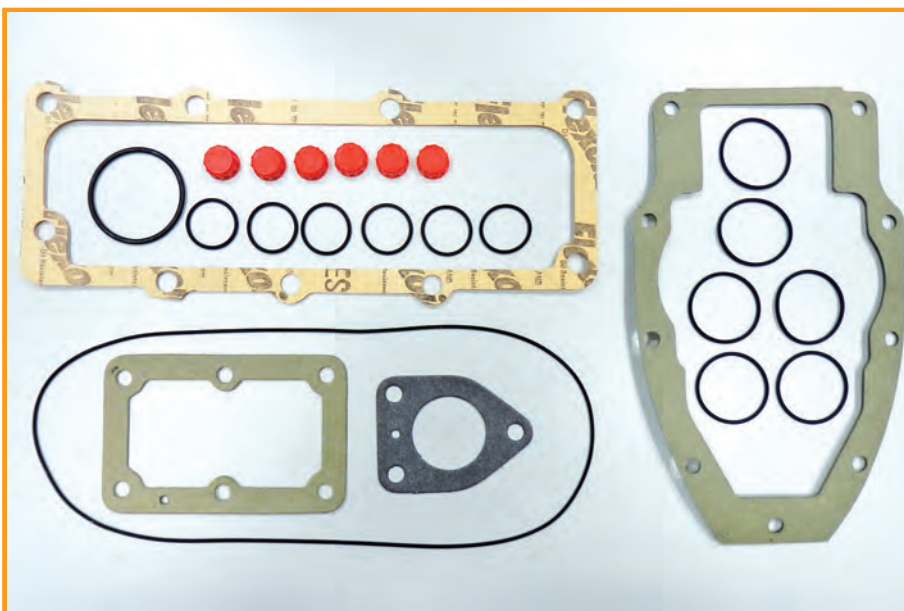

CODICE OMS 10-15-212

COD. KT-401705

COD.

COD.

COD.

TIPO-TYPE AB -MODEL-300



CODICE OMS 10-15-213

COD. Denso 190890-0250

COD.

COD.

COD.

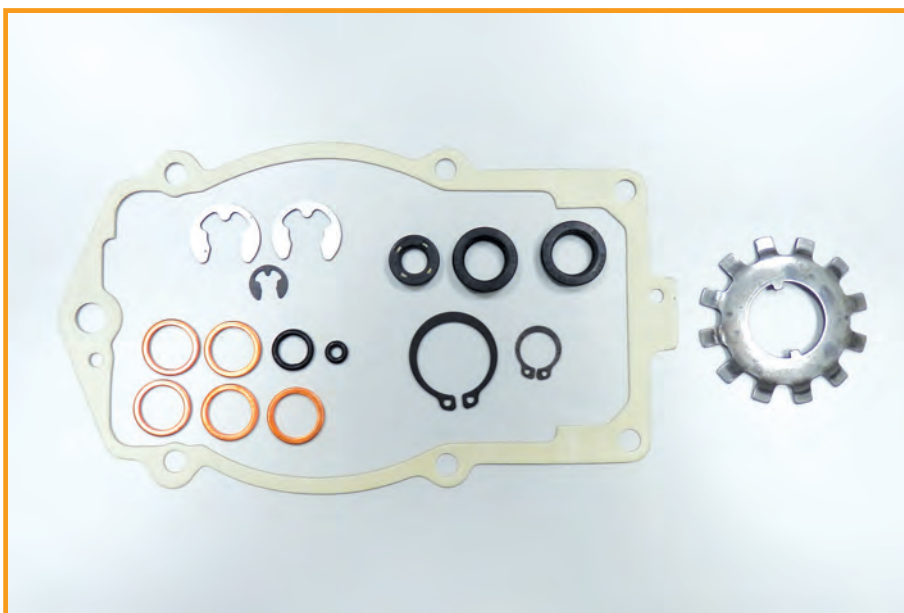

TIPO-TYPE DENSO

CODICE OMS 10-15-214

COD. 7135-399

COD.

COD.

COD.



TIPO-TYPE DELPHI

CODICE OMS 10-15-215

COD. DGK 506

COD.

COD.

COD.

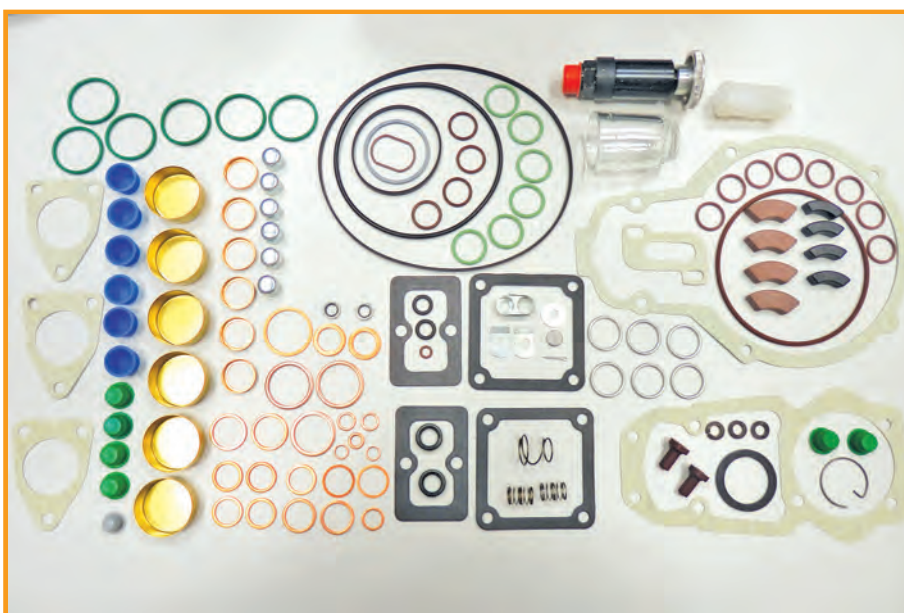

TIPO-TYPE DELPHI



CODICE OMS 10-15-216

COD. 294009-0080

COD.

COD.

COD.

TIPO-TYPE DENSO



CODICE OMS 10-15-217

COD. 294009-0032

COD.

COD.

COD.

TIPO-TYPE DENSO

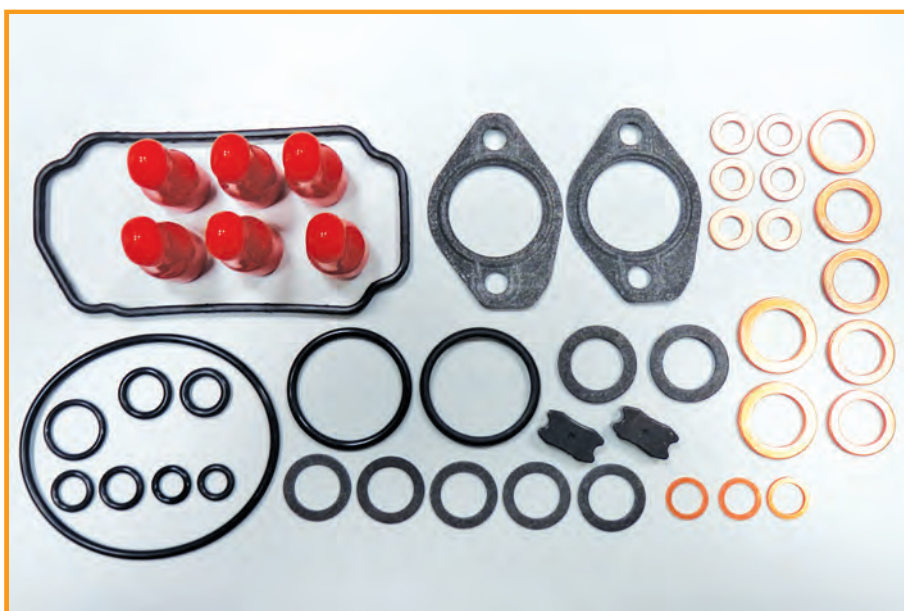

CODICE OMS 10-15-218

COD. Zexel 9 461 628 160

COD.

COD.

COD.

TIPO-TYPE



CODICE OMS 10-15-219

COD. MOTORPAL AVIA

COD.

COD.

COD.



TIPO-TYPE

CODICE OMS 10-15-220

COD. 294009-0031

COD.

COD.

COD.



TIPO-TYPE DENSO

CODICE OMS 10-15-221

APPLICAZIONE:
POMPE CPIII



TIPO-TYPE



10-15-***



CODICE OMS 10-15-222

APPLICAZIONE:
POMPE CPIII

TIPO-TYPE



CODICE OMS 10-15-223

APPLICAZIONE:
POMPE CPIII

TIPO-TYPE



CODICE OMS 10-15-224

APPLICAZIONE:
POMPA MERCEDES/BENZ
OM 904 / 906 / 924 / 926
MODERNO

TIPO-TYPE



CODICE OMS 10-15-225

APPLICAZIONE:
POMPA MERCEDES/BENZ
OM 904 / 906 / 924 / 926
MODERNO



TIPO-TYPE

CODICE OMS 10-15-226

COD. Bh 1 467 010 002



TIPO-TYPE PE(S) 4A..D..S 1000

CODICE OMS 10-15-227

COD. Bh 1 467 010 516



TIPO-TYPE



CODICE OMS 10-15-228

COD. Bh 9 421 082 241

COD.

COD.

COD.

TIPO-TYPE

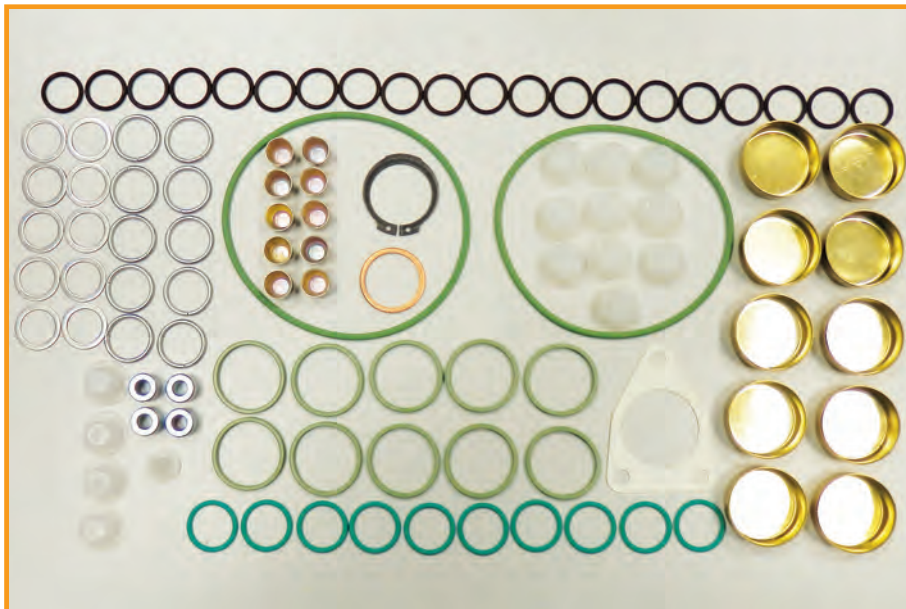

CODICE OMS 10-15-229

COD. Bh 2 417 010 024

COD.

COD.

COD.

TIPO-TYPE

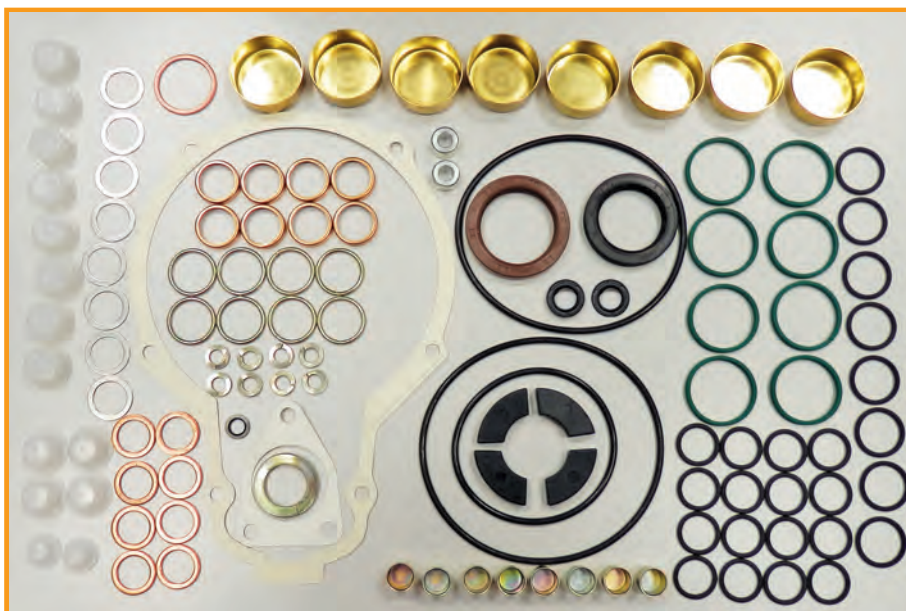

CODICE OMS 10-15-230

COD. Bh 2 417 010 022

+ kit regolatore

COD.

COD.

COD.

TIPO-TYPE



CODICE OMS 10-15-016/1

COD. Bh 2 417 010 003
 COD.
 COD.
 COD.

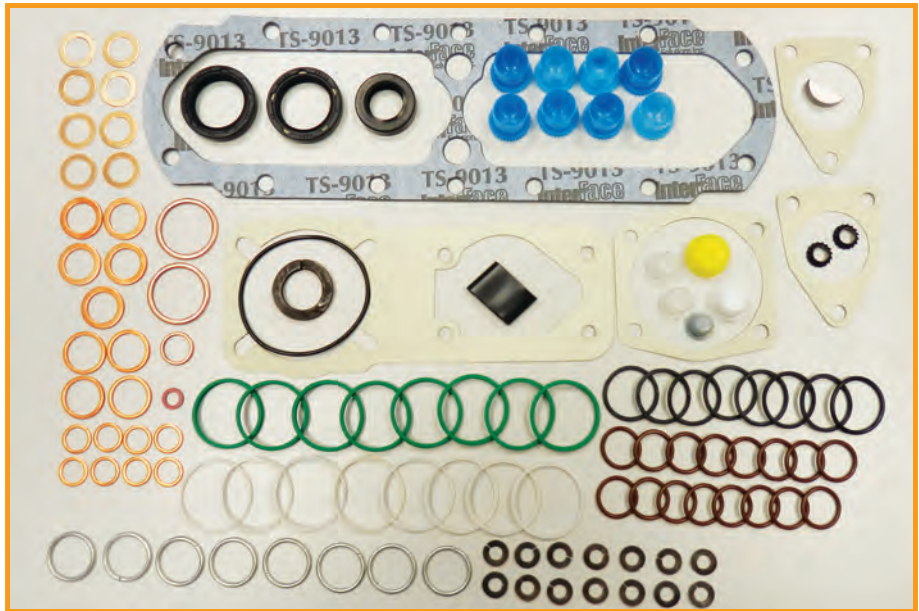

TIPO-TYPE PE8P...

CODICE OMS 10-15-047/1

COD. 9 461 087 009
 720 RS 3000 FIAT
 MERCEDES SCANIA
 VOLVO
 Versione Brasile



TIPO-TYPE PE6P110A...

CODICE OMS 10-15-179/1

COD. 9 461 080 509/1
 COD.
 COD.
 COD.

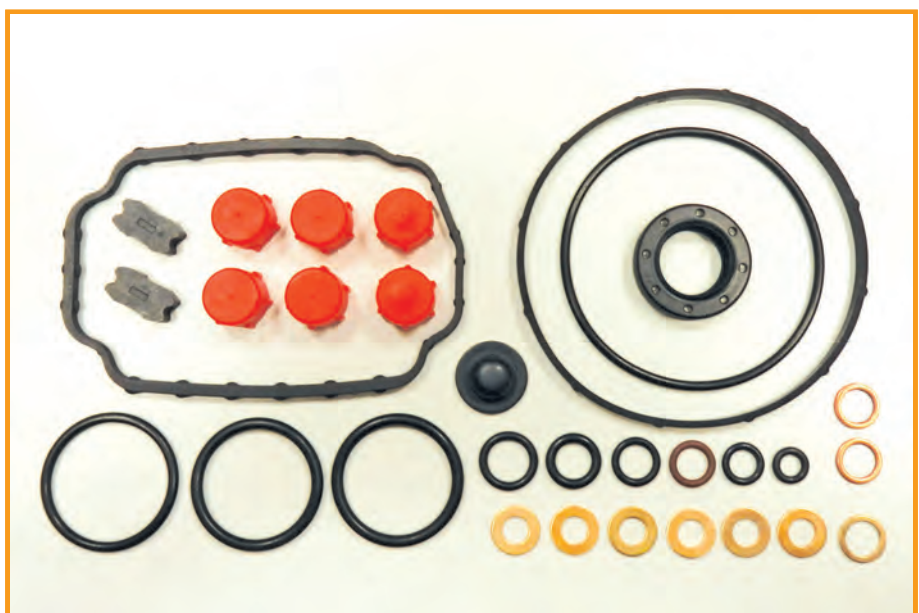

TIPO-TYPE EP/VE...F...

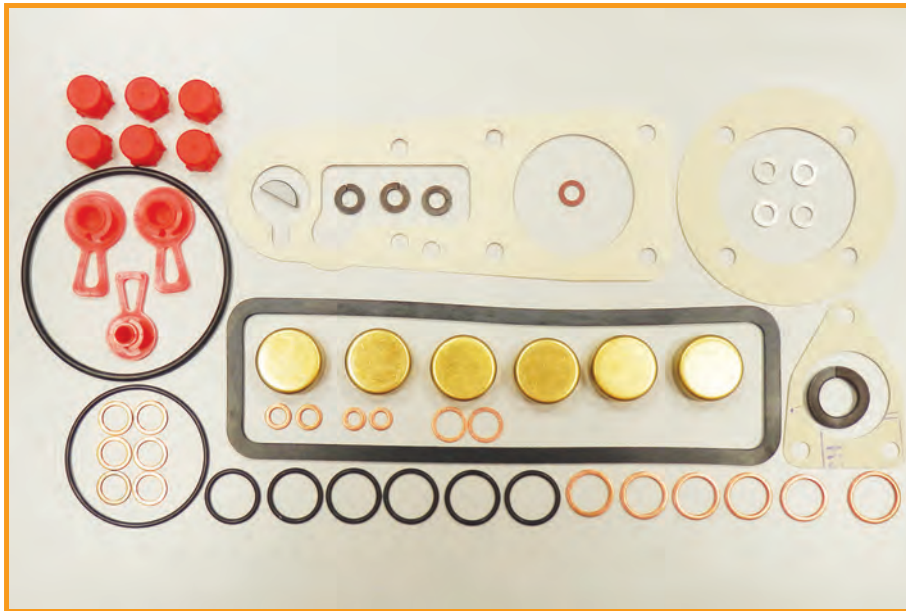

CODICE OMS 10-15-231

COD. Bh F 002 A10 614

COD. _____

COD. _____

COD. _____

TIPO-TYPE



CODICE OMS 10-15-232

COD. Bh 1 467 010 059/3

COD. _____

COD. _____

COD. _____

TIPO-TYPE



CODICE OMS 10-15-233

COD. Bh 2 417 010 026

COD. _____

COD. _____

COD. _____

TIPO-TYPE



CODICE OMS 10-15-234

COD. Bh 2 417 010 037
 COD.
 COD.
 COD.

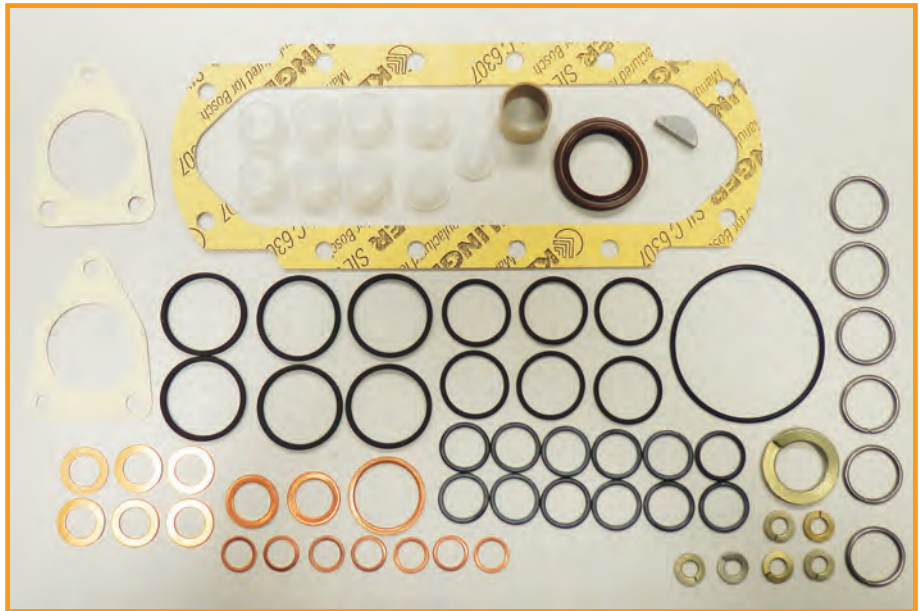

TIPO-TYPE

CODICE OMS 10-15-235

COD. Bh 2 417 010 024
 COD.
 COD.
 COD.

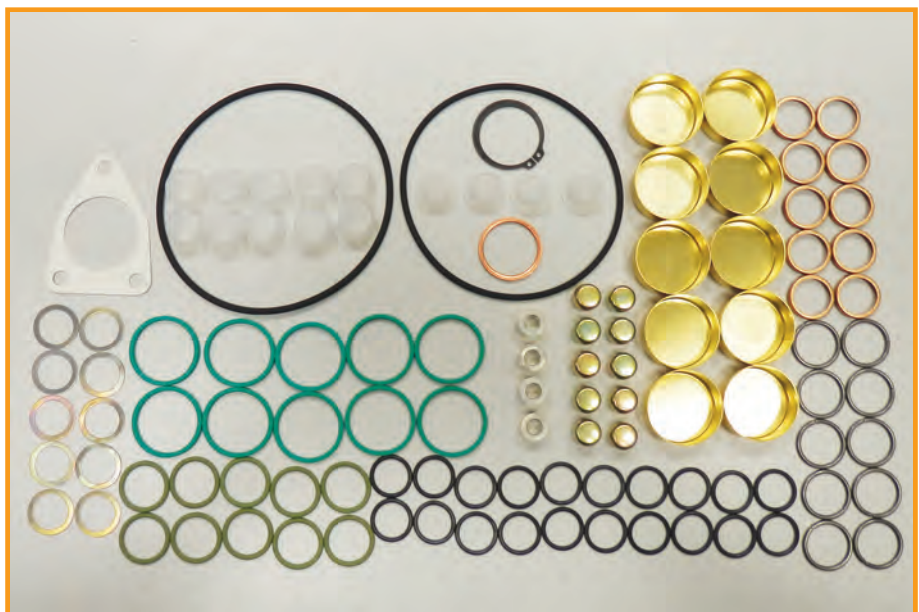

TIPO-TYPE

CODICE OMS 10-15-236

COD. Bh 2 417 010 019
 COD.
 COD.
 COD.

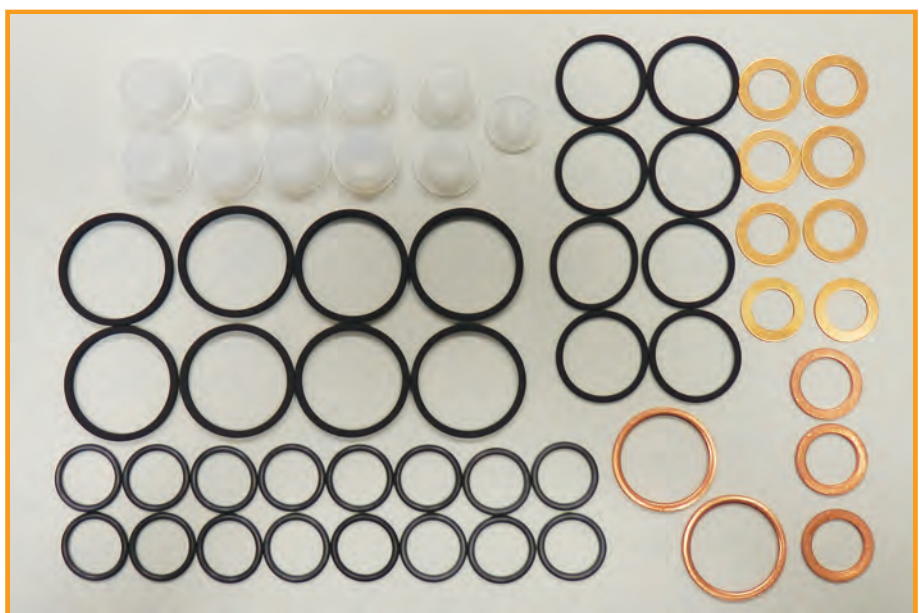

TIPO-TYPE



CODICE OMS 10-15-237

COD. Bh 2 417 010 018

COD. _____

COD. _____

COD. _____

TIPO-TYPE

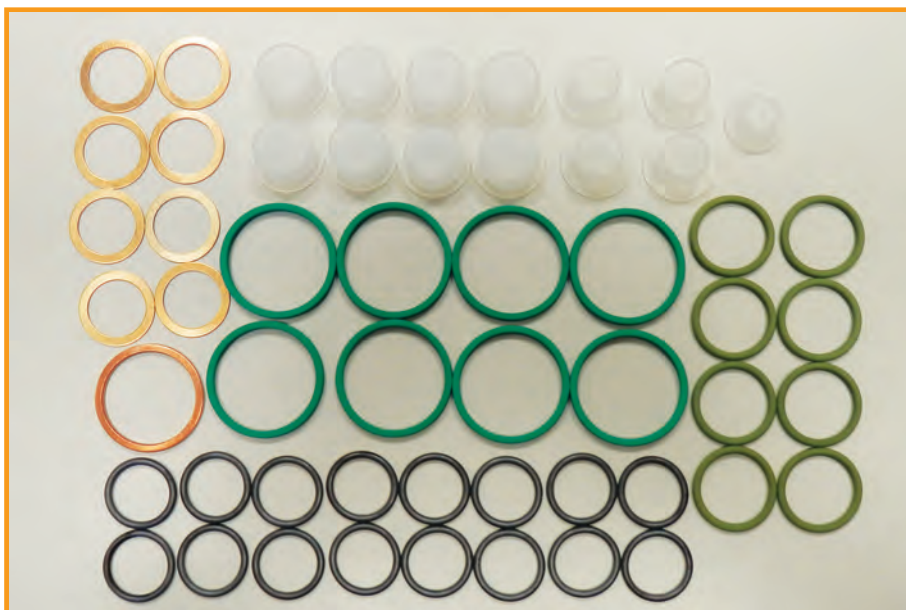

CODICE OMS 10-15-238

COD. Bh 2 417 010 017

COD. _____

COD. _____

COD. _____

TIPO-TYPE



CODICE OMS 10-15-239

COD. 135599-1420

COD. _____

COD. _____

COD. _____

TIPO-TYPE MD-TICS



CODICE OMS 10-15-240

COD. DGK 208

COD.

COD.

COD.

Con paraolio rettificato
20x30x7

TIPO-TYPE RQV...K...GOVERNOR

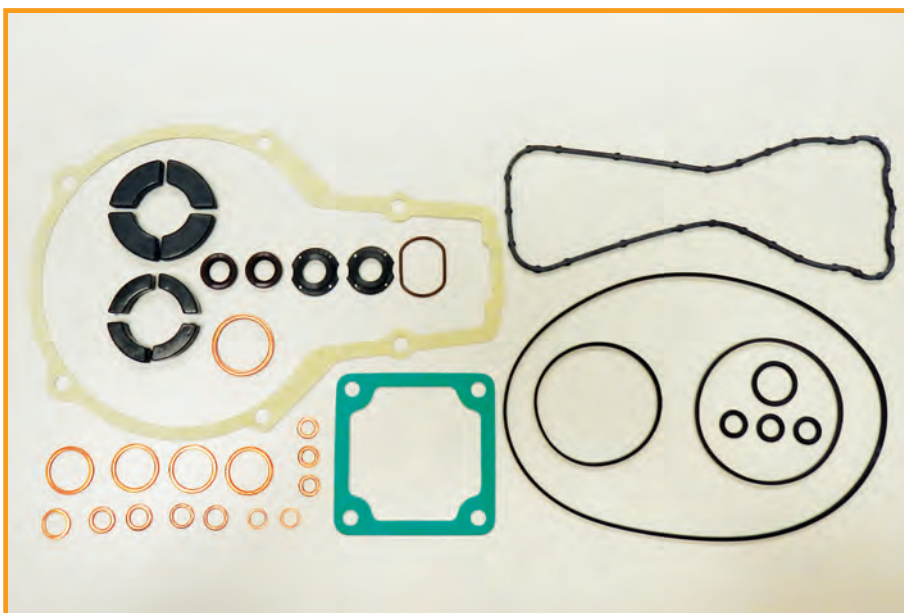

CODICE OMS 10-15-241

COD. Bh 2 417 010 039

COD.

COD.

COD.

TIPO-TYPE

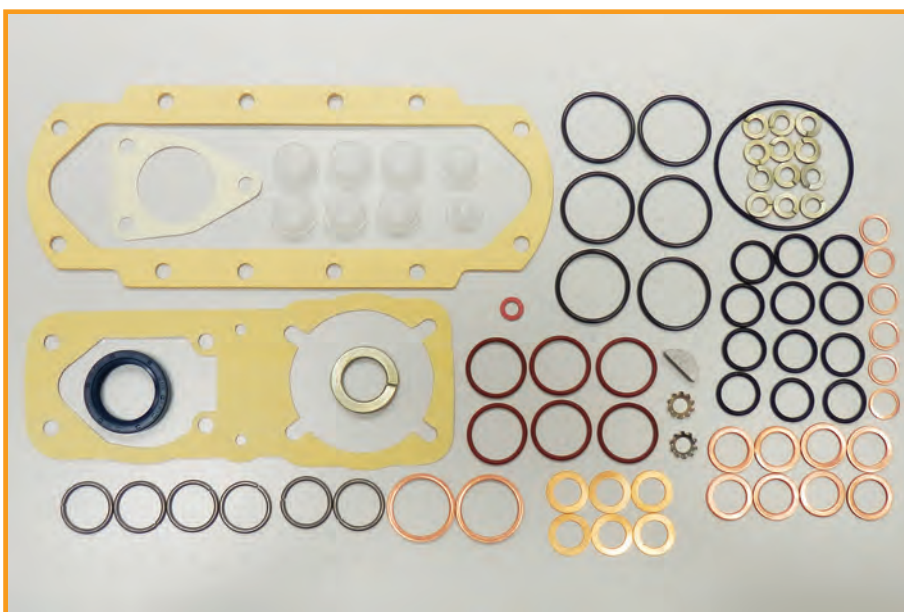

CODICE OMS 10-15-242

COD. Bh 2 417 010 043

COD.

COD.

COD.

TIPO-TYPE

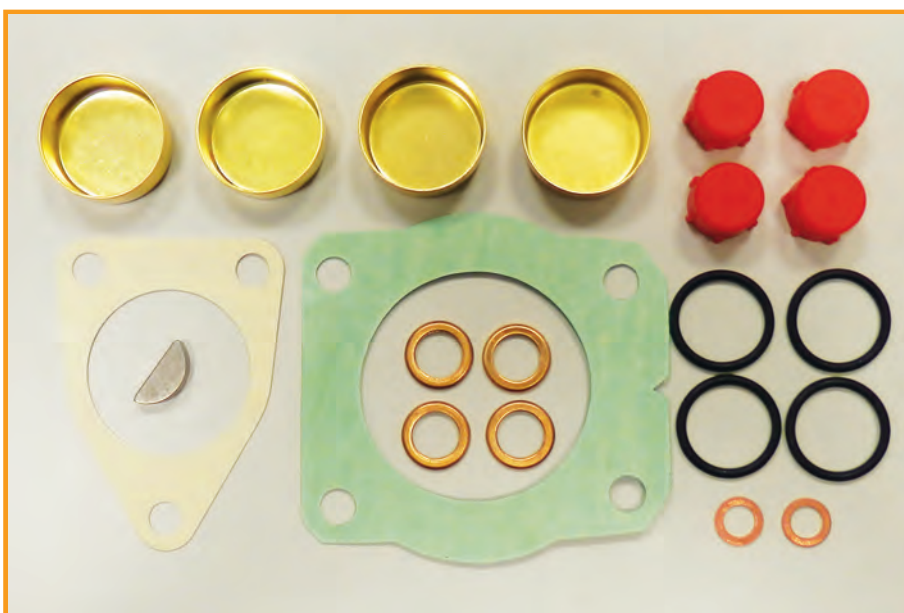



CODICE OMS 10-15-243

COD. Zexel 9 411 610 988
131499-2020

COD.

COD.

COD.

TIPO-TYPE



CODICE OMS 10-15-244

COD. Denso 294009-0110

COD.

COD.

COD.

TIPO-TYPE

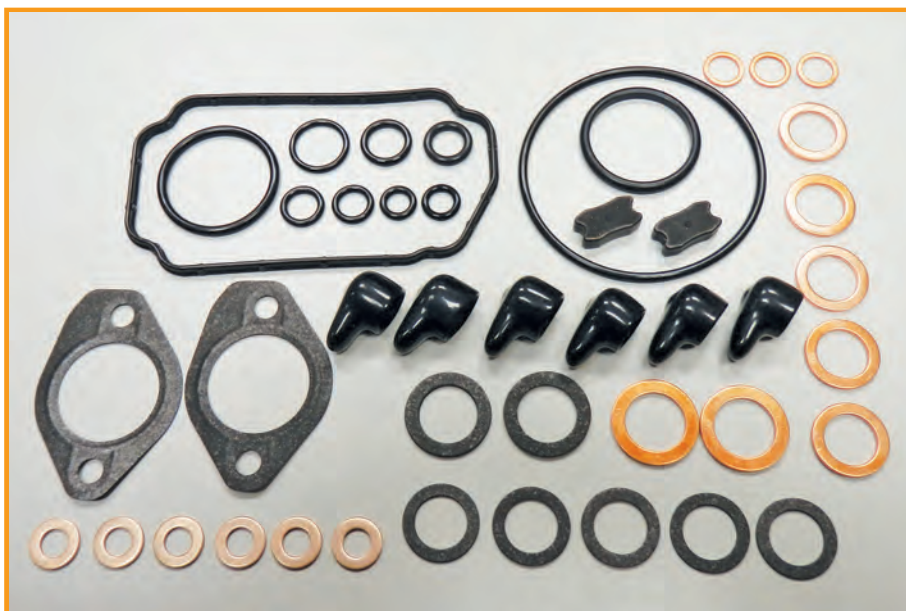

CODICE OMS 10-15-245

COD. Zexel 9 461 628 160
146600-6320

COD.

COD.

COD.

TIPO-TYPE



CODICE OMS 10-15-246

COD. Bh 1 467 010 059DS

COD.

COD.

COD.



TIPO-TYPE EP/VE...F...

CODICE OMS 10-15-247

COD. Bh 1 417 010 016

COD.

COD.

COD.



TIPO-TYPE PE(S)4-5-6M / RSF

CODICE OMS 10-15-248

COD. Bh 1 417 010 017

COD.

COD.

COD.

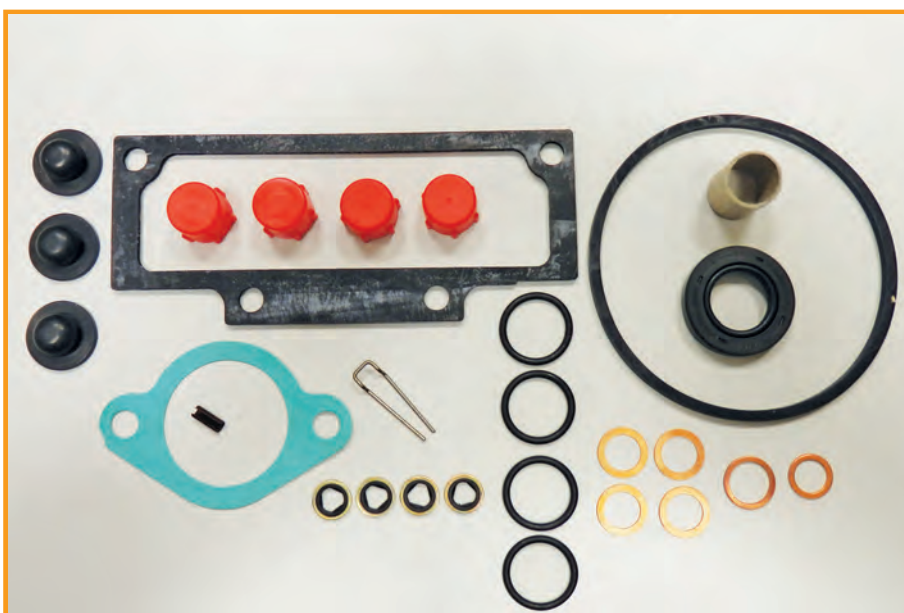

TIPO-TYPE PE(S)4-5-6M

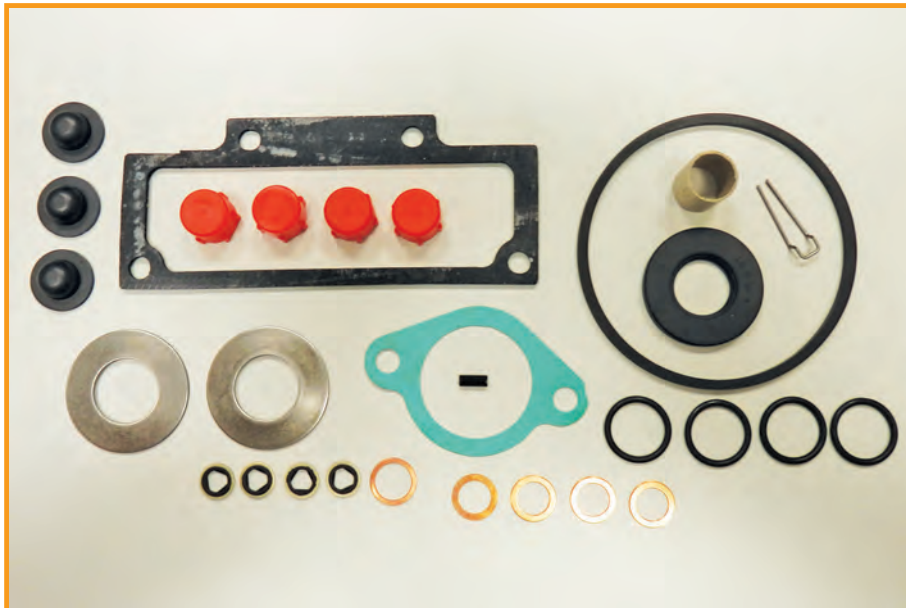

CODICE OMS 10-15-249

COD. Bh 1 417 010 018

COD. _____

COD. _____

COD. _____

TIPO-TYPE PE(S)4-5-6M

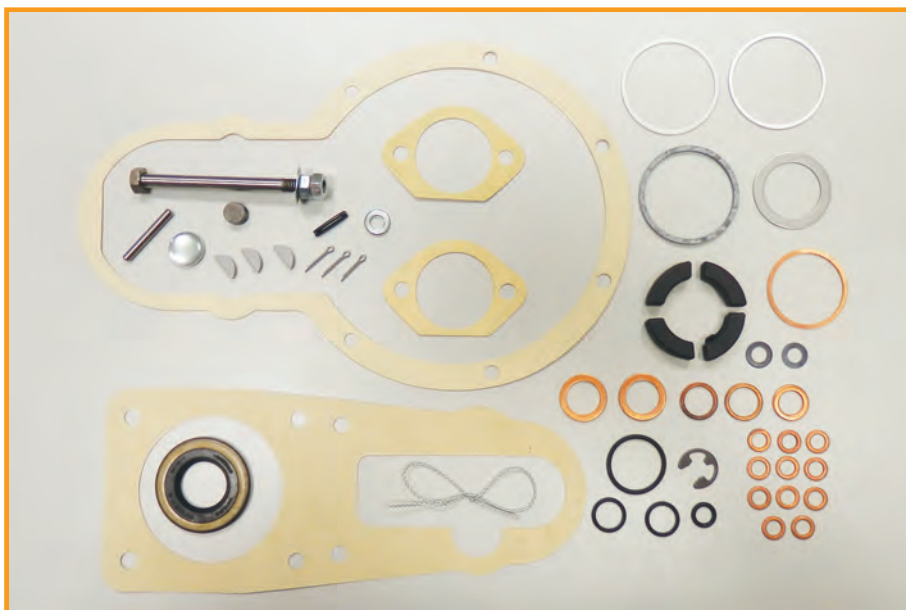

CODICE OMS 10-15-250

COD. GK 303

COD. _____

COD. _____

COD. _____

TIPO-TYPE RPB/RPVB



CODICE OMS 10-15-251

COD. DGK 133

COD. _____

COD. _____

COD. _____

TIPO-TYPE PES6MW100/120RS



CODICE OMS 10-15-252

COD. Bh 1 497 010 059/1

COD.

COD.

COD.

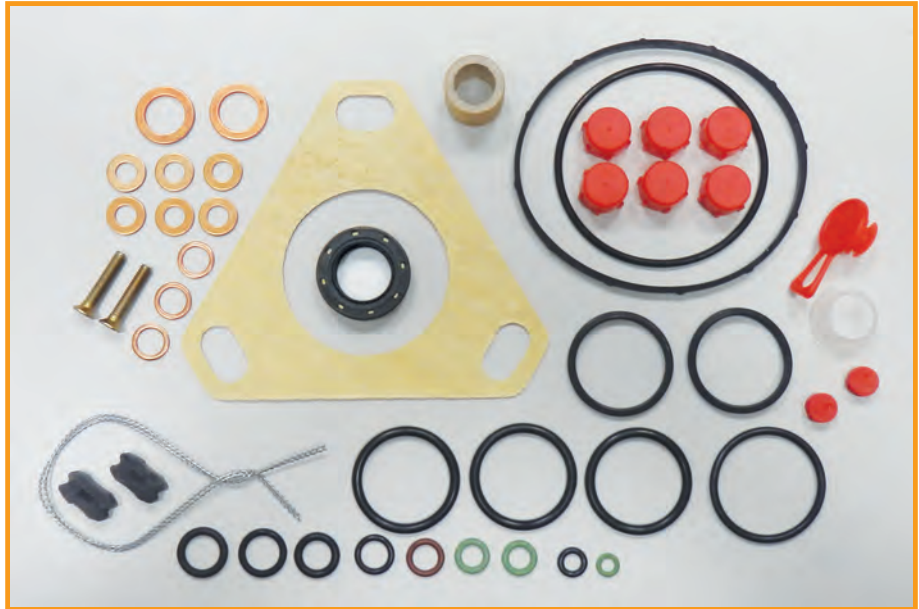

TIPO-TYPE EP/VE...F...

CODICE OMS 10-15-253

COD. Bh 1 417 010 021

COD.

COD.

COD.

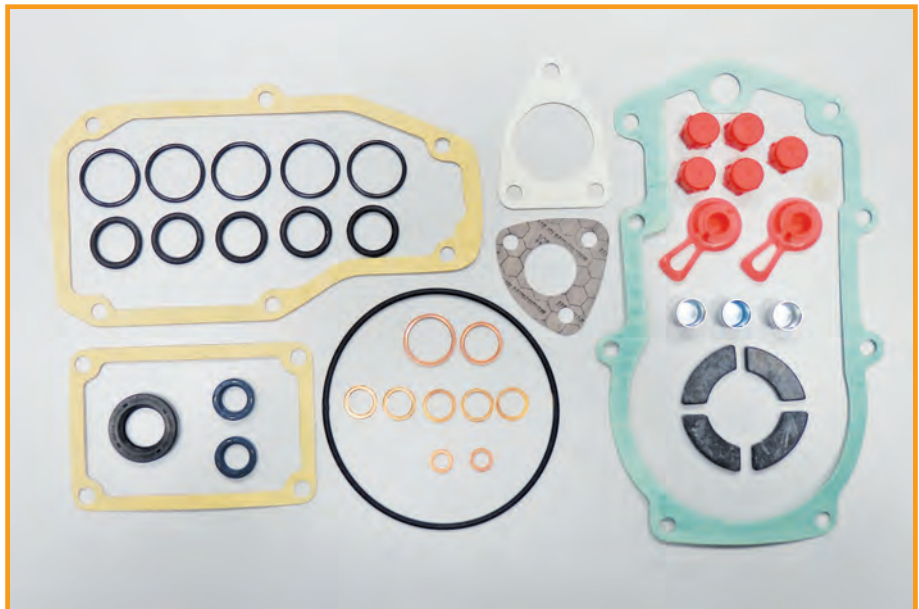

TIPO-TYPE PE(S)5MW..RW/RWV

CODICE OMS 10-15-254

COD. Denso 098010-0040

COD.

COD.

COD.

Momentaneamente non fornibile
Temporarily can not be supplied



TIPO-TYPE



CODICE OMS 10-15-255

COD. Denso 098010-0060

COD. _____

COD. _____

COD. _____

Momentaneamente non fornibile
Temporarily can not be supplied

TIPO-TYPE



CODICE OMS 10-15-256

COD. Bh 9 443 612 894

COD. Denso 149960-0020

COD. _____

COD. _____

TIPO-TYPE

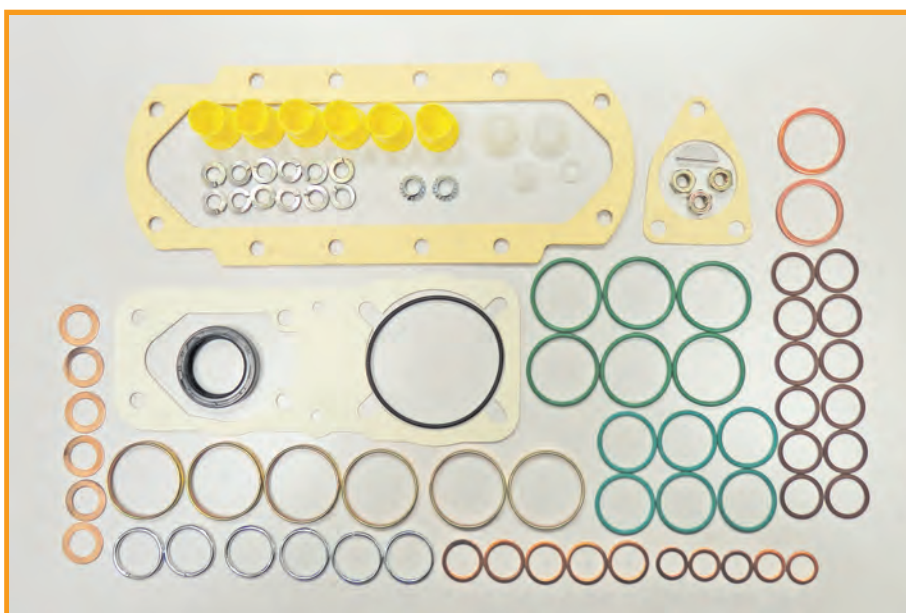

CODICE OMS 10-15-014/5

COD. Bh 2 417 010 001/I

COD. _____

COD. _____

COD. _____

TIPO-TYPE



CODICE OMS 10-15-263

COD. 120 - 15A

COD.

COD.

COD.

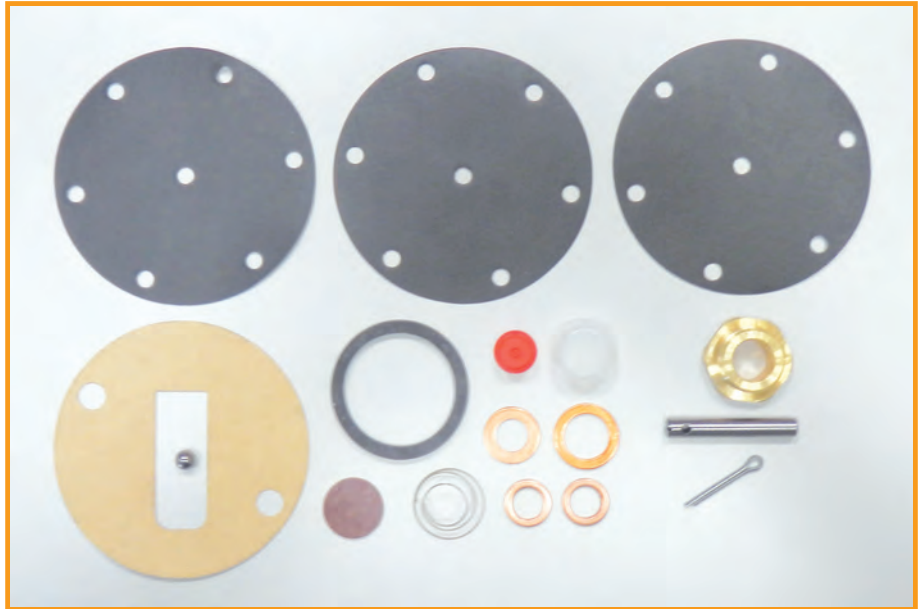

TIPO-TYPE

CODICE OMS 10-15-264

COD. Caterpillar 8T-2484

COD.

COD.

COD.



TIPO-TYPE

CODICE OMS 10-15-265

COD. Caterpillar 6V-8902

COD.

COD.

COD.

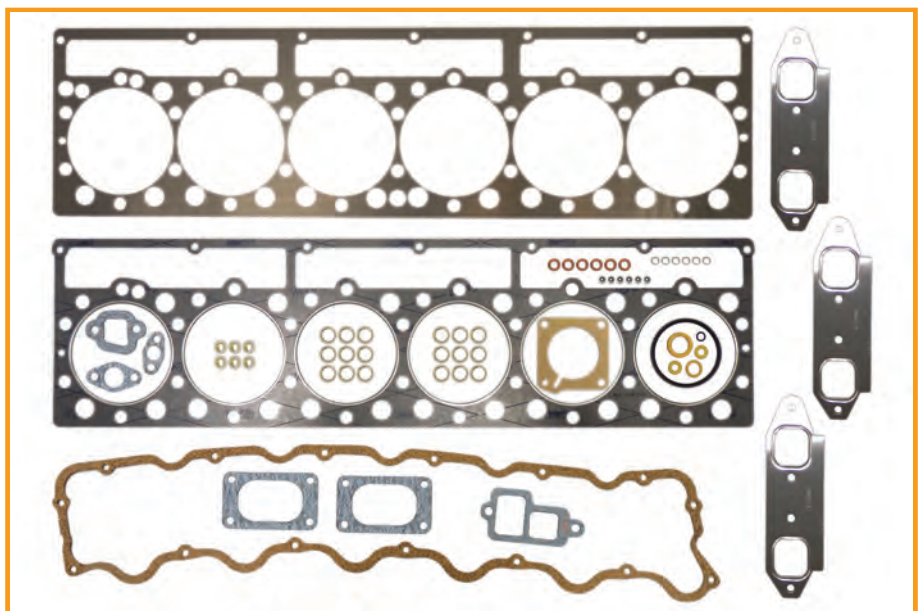

TIPO-TYPE

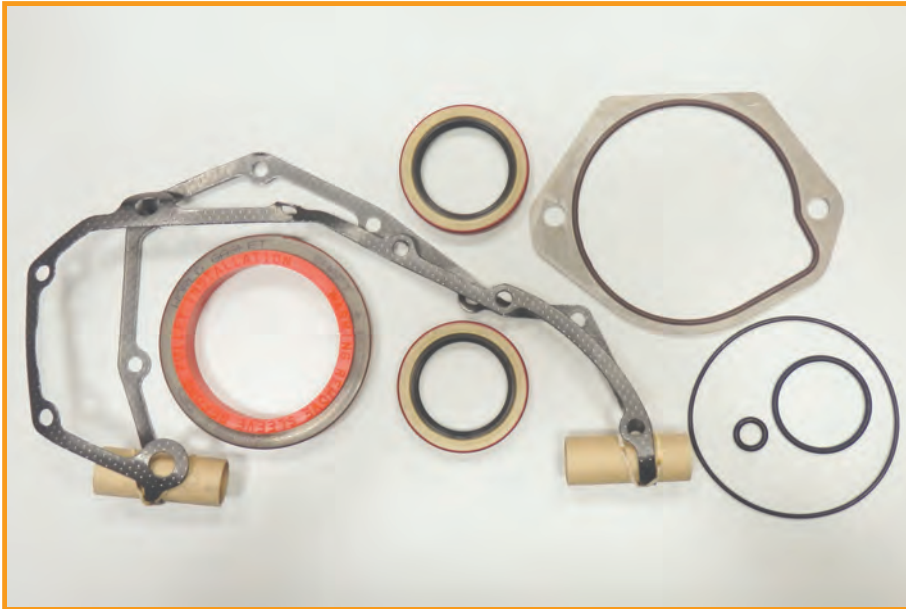

CODICE OMS 10-15-266

COD. Caterpillar 3E-3278

COD.

COD.

COD.

TIPO-TYPE



CODICE OMS 10-15-267

COD. Gasket kit

COD. YANMAR/KUBOTA

COD.

COD.

TIPO-TYPE BOBCAT 3 CIL.

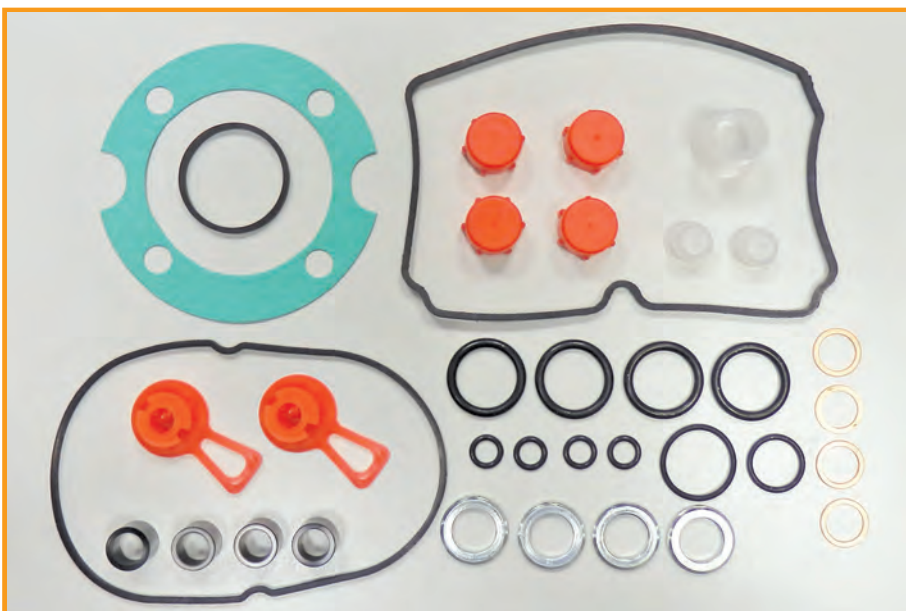

CODICE OMS 10-15-268

COD. Gasket kit

COD. YANMAR/KUBOTA

COD.

COD.

TIPO-TYPE 4 CIL.



CODICE OMS 10-15-269

COD. Gasket kit

COD. GOVERNOR YANMAR

COD.

COD.

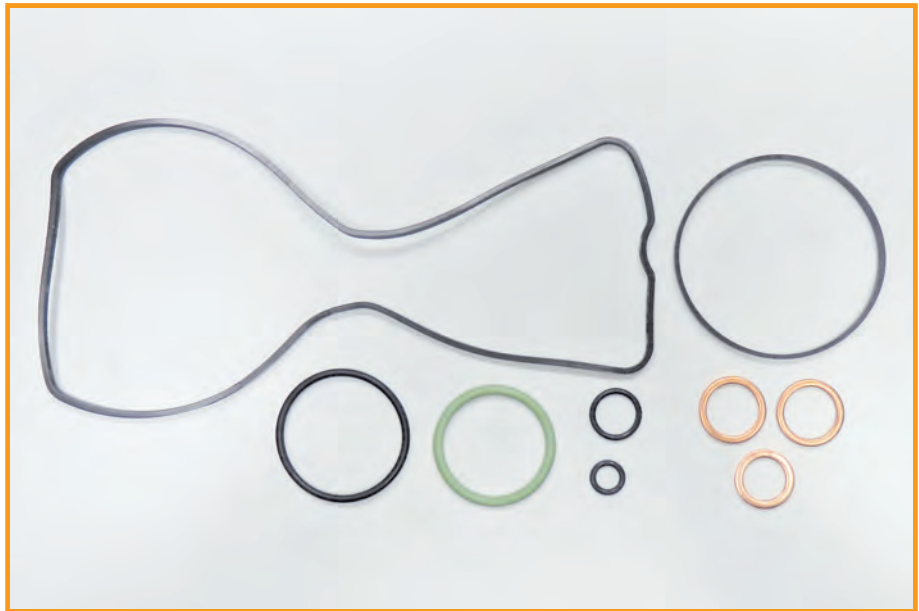

TIPO-TYPE 3/4 CIL.

CODICE OMS 10-15-193/1

COD. Denso 096010-0010//

COD.

COD.

COD.



TIPO-TYPE





CODICE OMS 10-16-001

COD. Bh 1 467 010 497
 Boccola Lungh. 20 mm
 rif. or. Bh 1 460 324 315
 Guarnizione gomma
 1 461 015 300/301/302

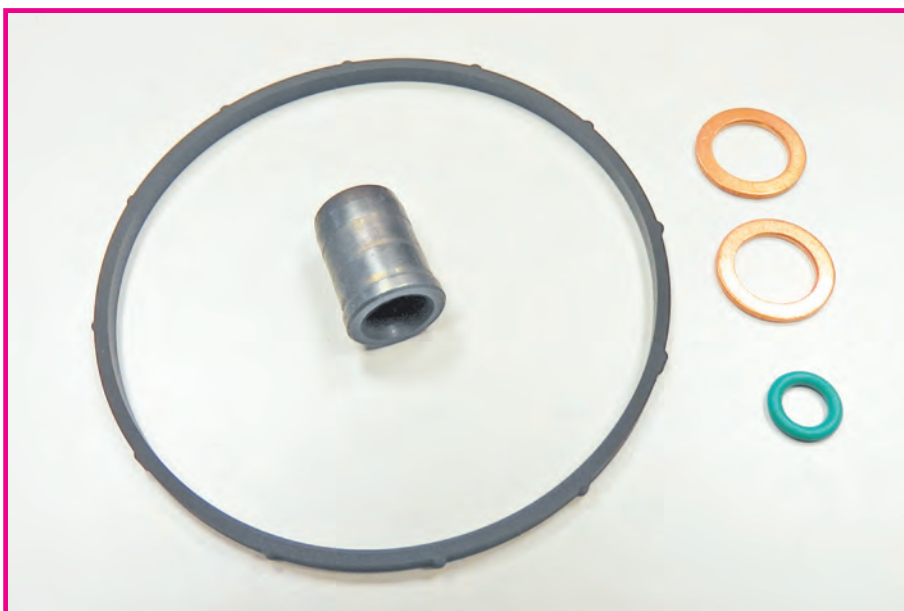

TIPO-TYPE

CODICE OMS 10-16-002

COD. Bh 1 467 010 499
 Boccola Lungh. 25 mm
 rif. or. Bh 1 460 324 316
 Guarnizione gomma
 1 461 015 300/301/302

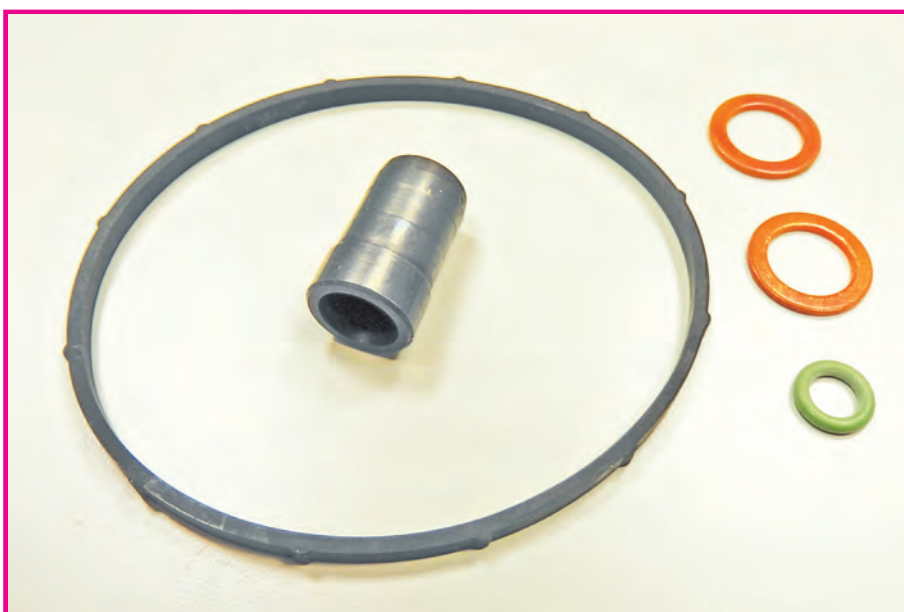

TIPO-TYPE

CODICE OMS 10-16-003

COD. Boccola Lungh. 30,5 mm
 rif. or. Bh 1 460 324 333
 Guarnizione gomma
 1 461 015 300/301/302

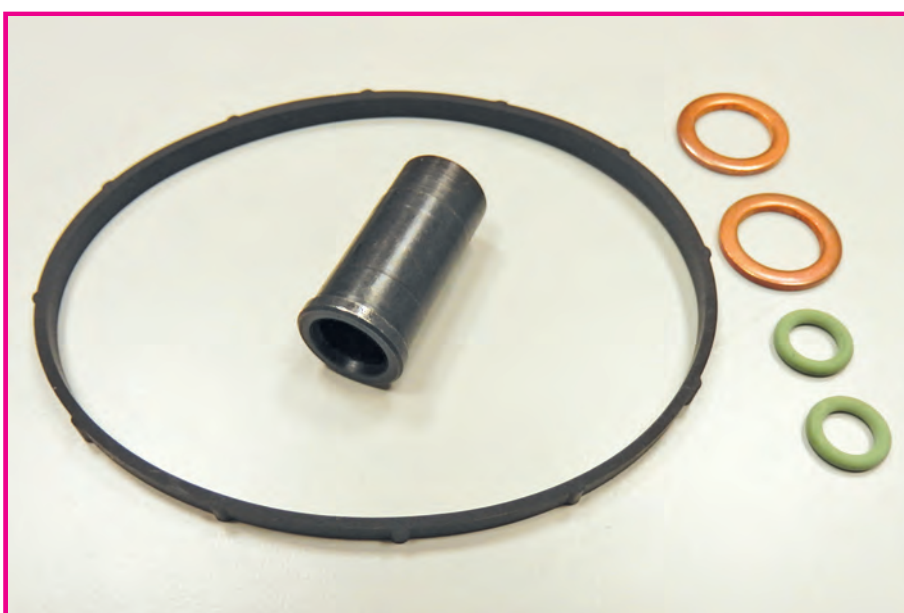

TIPO-TYPE



10-16-***



CODICE OMS 10-16-004

COD.

Boccola Lungh. 35 mm
rif. or. Bh 1 460 324 332

Guarnizione gomma
1 461 015 300/301/302

TIPO-TYPE



CODICE OMS 10-16-005

COD.

Boccola Lungh. 40,5 mm
rif. or. Bh 1 460 324 331

Guarnizione gomma
1 461 015 300/301/302

TIPO-TYPE

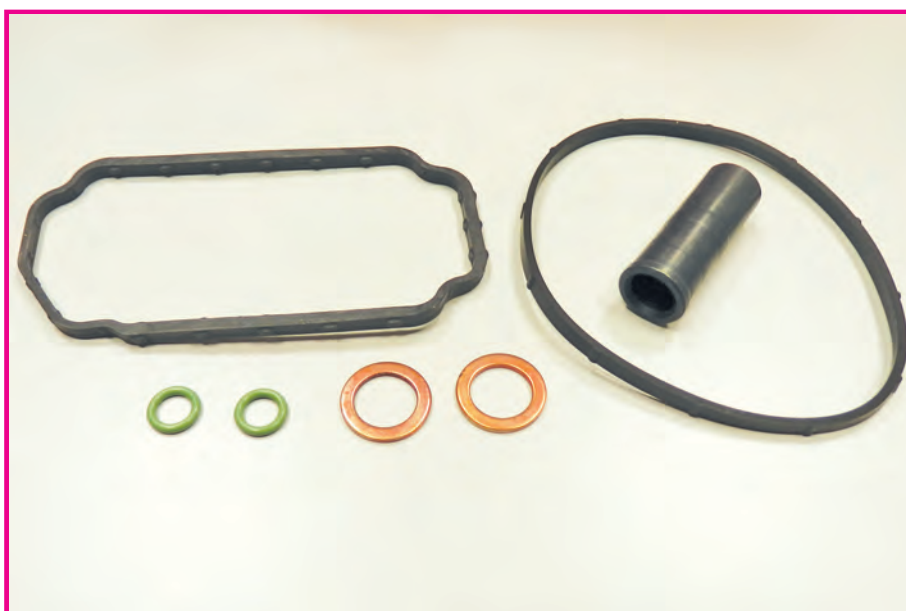

CODICE OMS 10-16-006

COD.

Boccola Lungh. 40,5 mm
rif. or. Bh 1 460 324 331

Guarnizione gomma
1 460 206 301/303

Guarnizione gomma
1 461 015 300/301/302

TIPO-TYPE

CODICE OMS 10-16-007

COD.

Boccola Lungh. 33,5 mm
rif. or. Bh 1 460 324 337

Guarnizione gomma
1 460 206 301/303

Guarnizione gomma
1 461 015 300/301/302



TIPO-TYPE

CODICE OMS 10-16-008

COD.

Boccola Lungh. 35 mm
rif. or. Bh 1 460 324 332

Guarnizione gomma
1 460 206 301/303

Guarnizione gomma
1 461 015 300/301/302

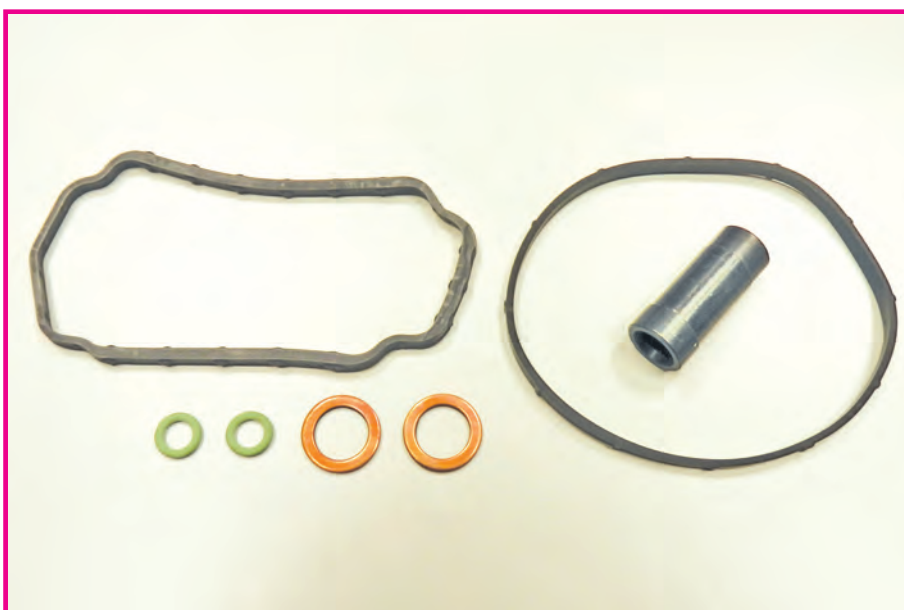

TIPO-TYPE

CODICE OMS 10-16-009

COD.

Bh 1 467 010 501

Boccola Lungh. 30,5 mm
rif. or. Bh 1 460 324 333

Guarnizione gomma
1 460 206 301/303

Guarnizione gomma
1 461 015 300/301/302

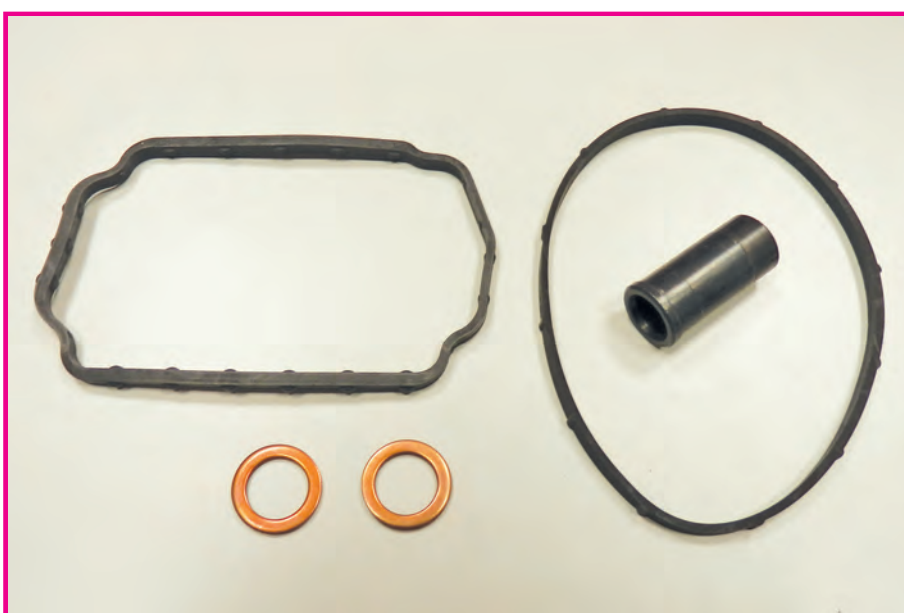

TIPO-TYPE



10-16-***

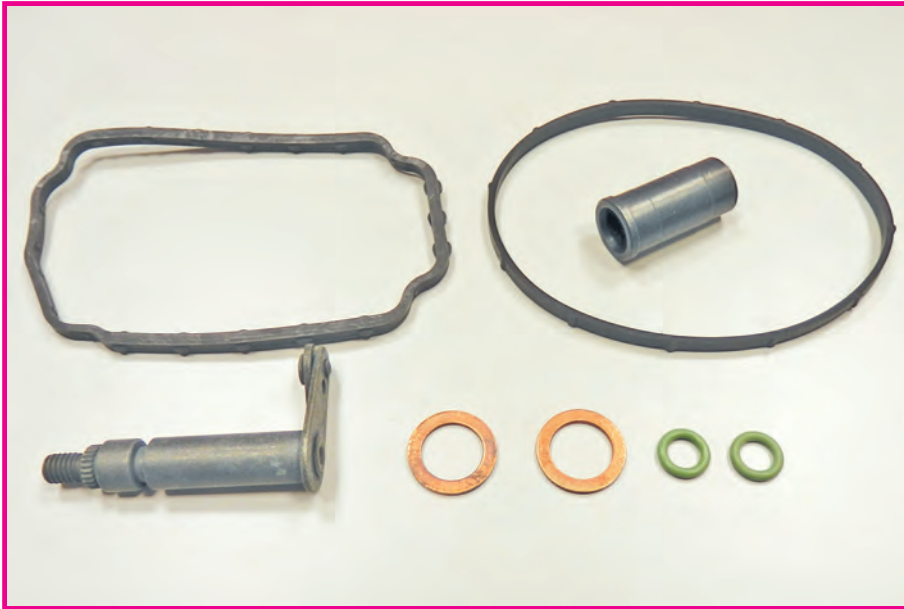

CODICE OMS 10-16-011

COD. Bh 1 467 010 502

Boccola Lungh. 30,5 mm
rif. or. Bh 1 460 324 333

Guarnizione gomma
1 460 206 301/303

Guarnizione gomma
1 461 015 300/301/302

Alberino 10-01-042
rif. or. 1 463 161 596

TIPO-TYPE



CODICE OMS 10-16-012

COD.

Boccola Lungh. 33,5 mm
rif. or. Bh 1 460 324 337

Guarnizione gomma
1 461 015 300/301/302

TIPO-TYPE



CODICE OMS 10-16-013

COD.

Boccola Lungh. 25 mm
rif. or. Bh 1 460 324 315

Guarnizione gomma
1 460 206 301/303

TIPO-TYPE



CODICE OMS 10-16-014

COD.

Boccola Lungh. 20 mm
rif. or. Bh 1 460 324 316

Guarnizione gomma
1 460 206 301/303

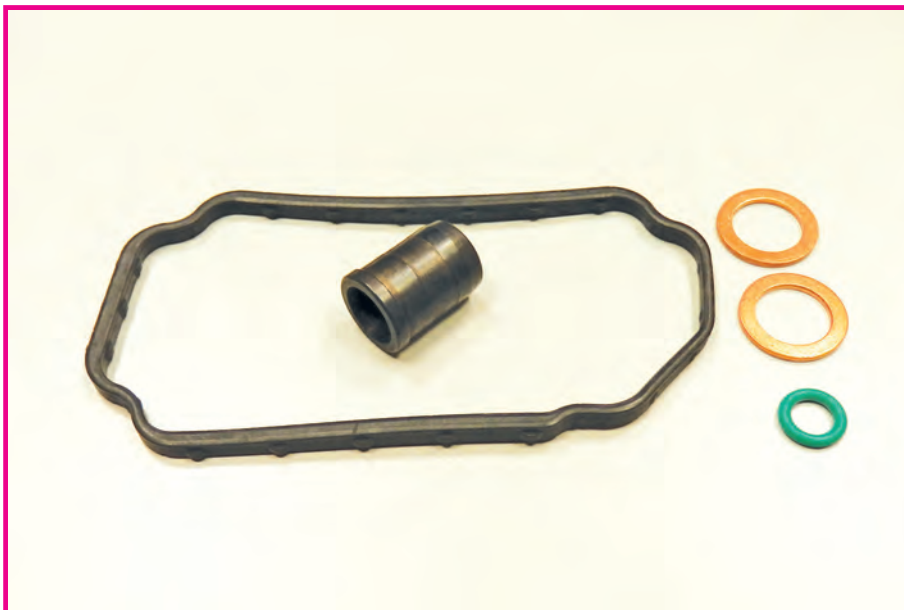

TIPO-TYPE

CODICE OMS 10-16-015

COD.

Bh 1 467 010 500

Boccola Lungh. 25 mm
rif. or. Bh 1 460 324 316

Guarnizione gomma
1 461 015 300/301/302

Alberino 10-01-015
1 463 161 366



TIPO-TYPE

CODICE OMS 10-16-016

COD.

Bh 1 467 010 498

Boccola Lungh. 25 mm
rif. or. Bh 1 460 324 315

Guarnizione gomma
1 461 015 300/301/302

Alberino 10-01-020
1 463 161 377

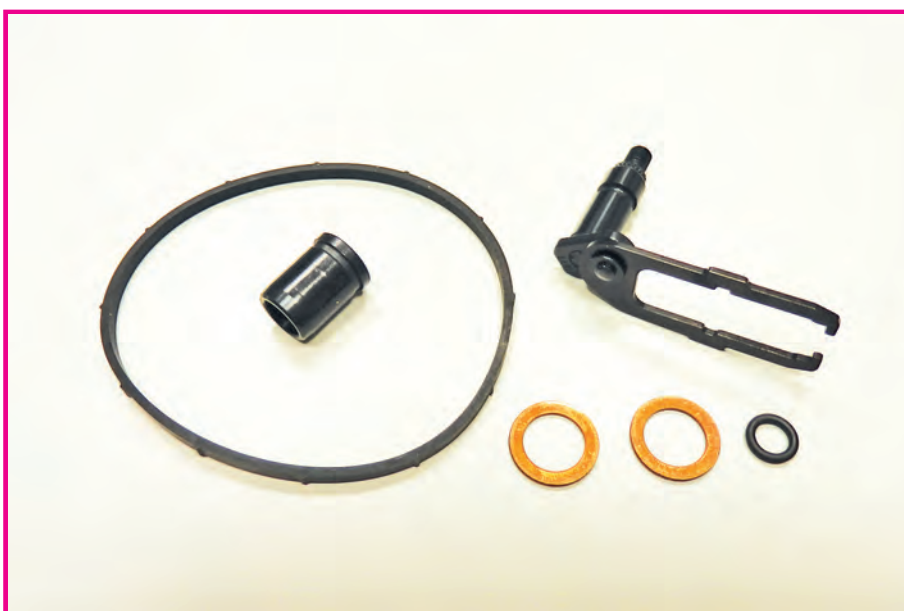

TIPO-TYPE



10-16-***

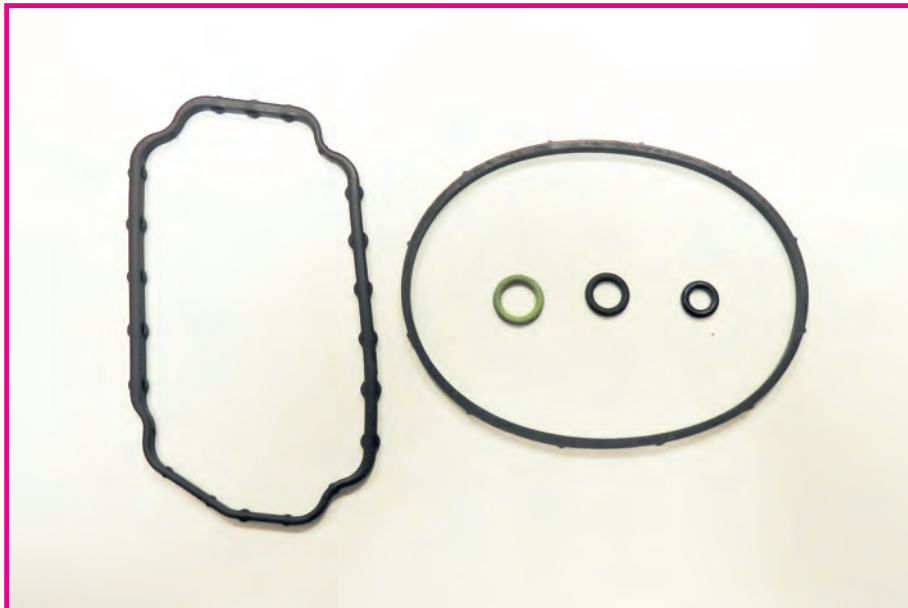

	CODICE OMS 10-16-017
COD.	Bh 1 467 010 425
	Guarnizione gomma 1 460 206 301/303
	Guarnizione gomma 1 461 015 300/301/302

TIPO-TYPE



CODICE OMS 11-09-001

COD. Lucas 7135-121

COD.

COD.

COD.

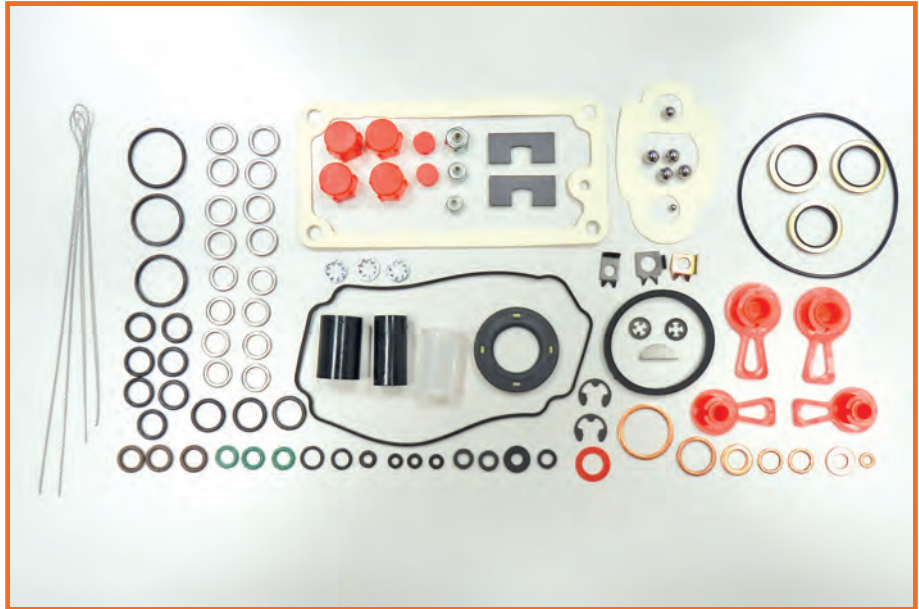

TIPO-TYPE DPS

CODICE OMS 11-09-017

COD. Lucas 7135-123

COD.

COD.

COD.

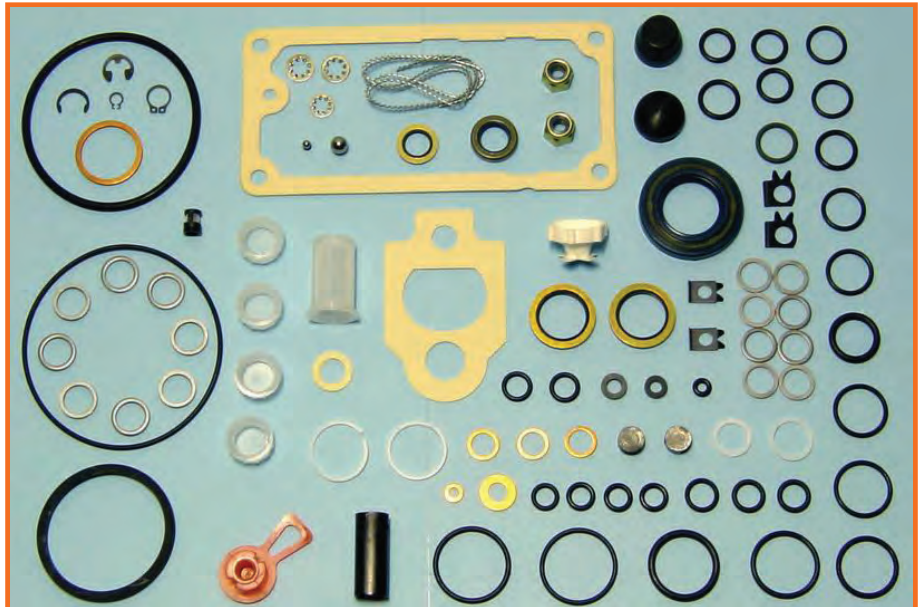

TIPO-TYPE DPS

CODICE OMS 11-09-018

COD. Lucas 7135-124

COD.

COD.

COD.

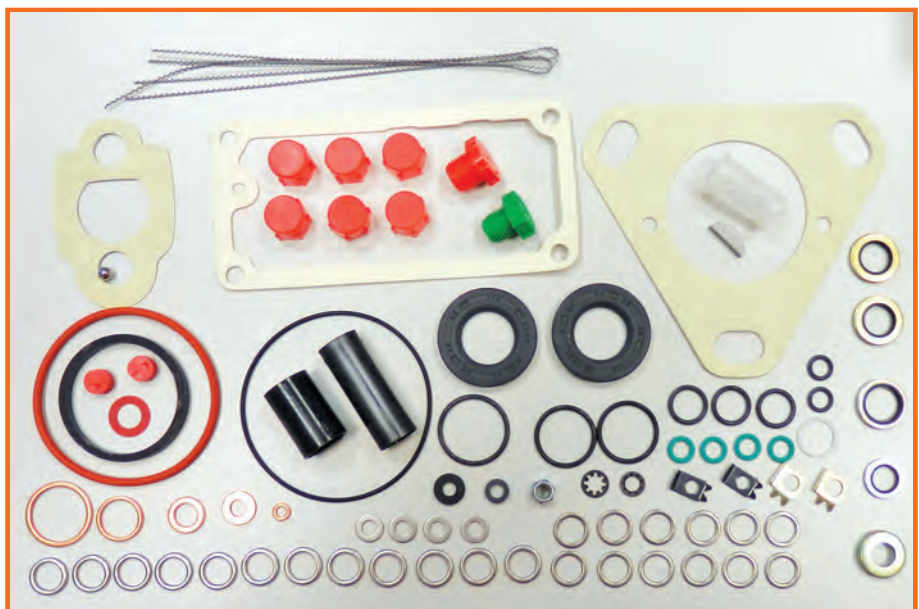

TIPO-TYPE DPS

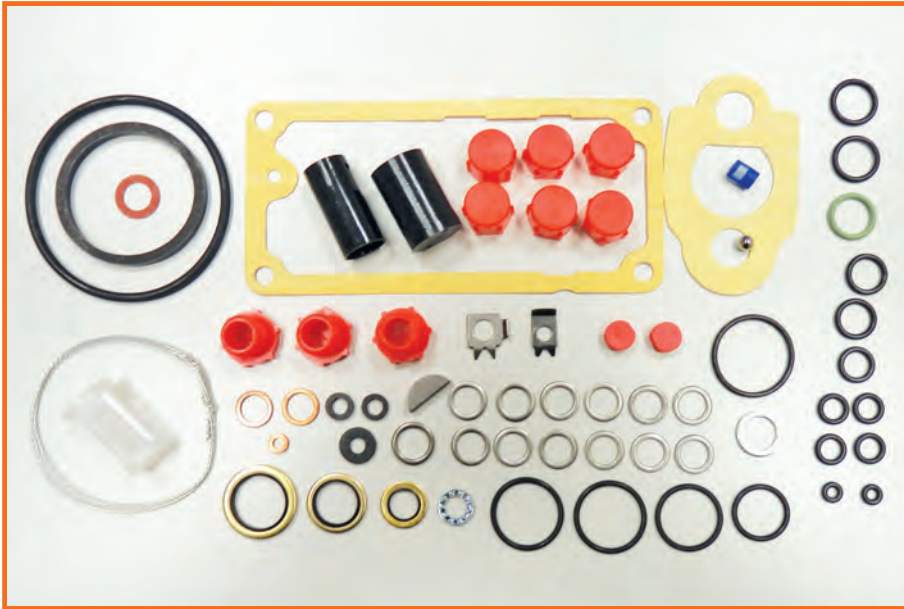

CODICE OMS 11-09-019

COD. Lucas 7135-126

COD.

COD.

COD.

TIPO-TYPE DPS

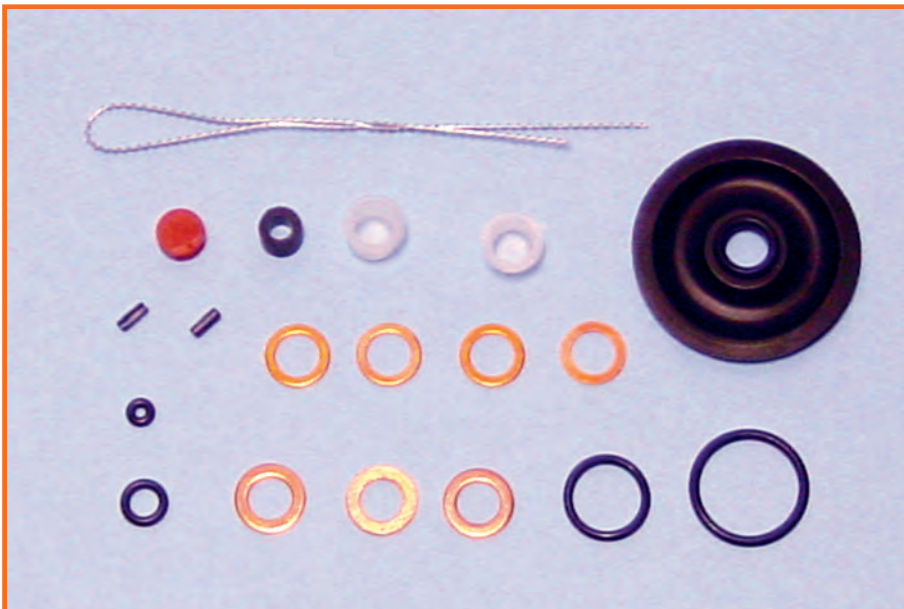

CODICE OMS 11-09-020

COD. Lucas 7135-125

COD.

COD.

COD.

TIPO-TYPE DPS

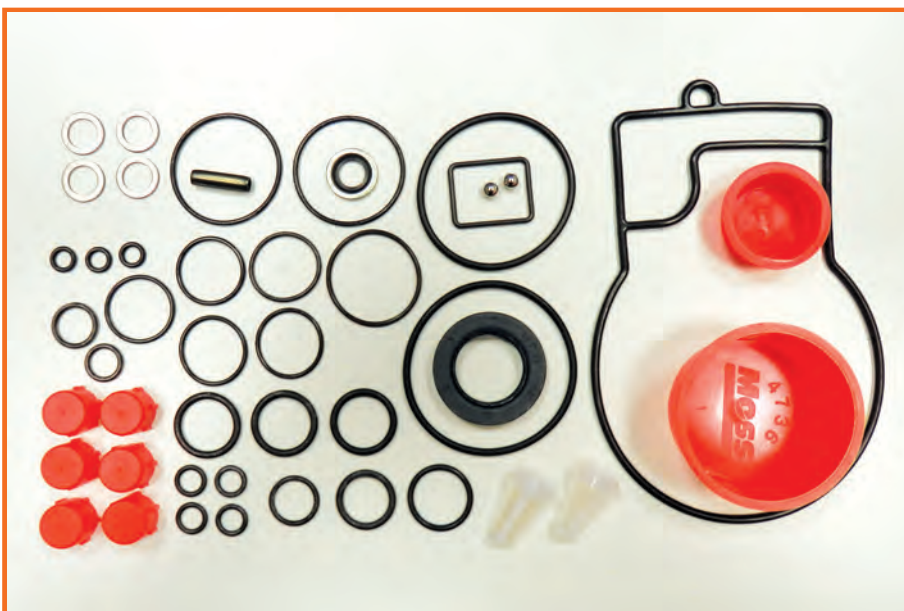

CODICE OMS 11-09-021

COD. Lucas 7135-237

COD.

COD.

COD.

TIPO-TYPE DPS



CODICE OMS 11-09-022

COD. Lucas 7135-70

COD. Lucas 7135-110

COD. Lucas 9009-089A

COD.

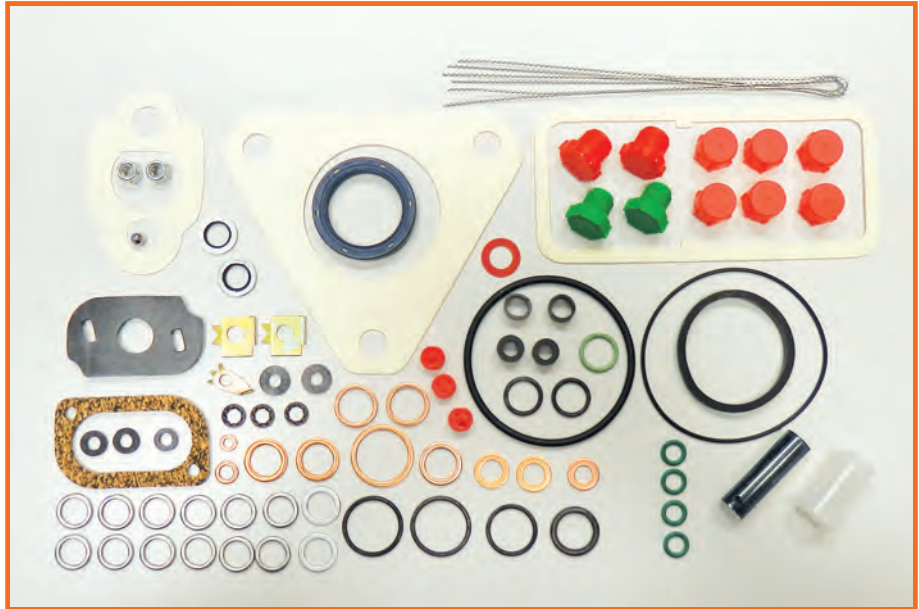

TIPO-TYPE DPA

CODICE OMS 11-09-022/1

COD. 9059-041A

COD.

COD.

COD.

Versione Brasile

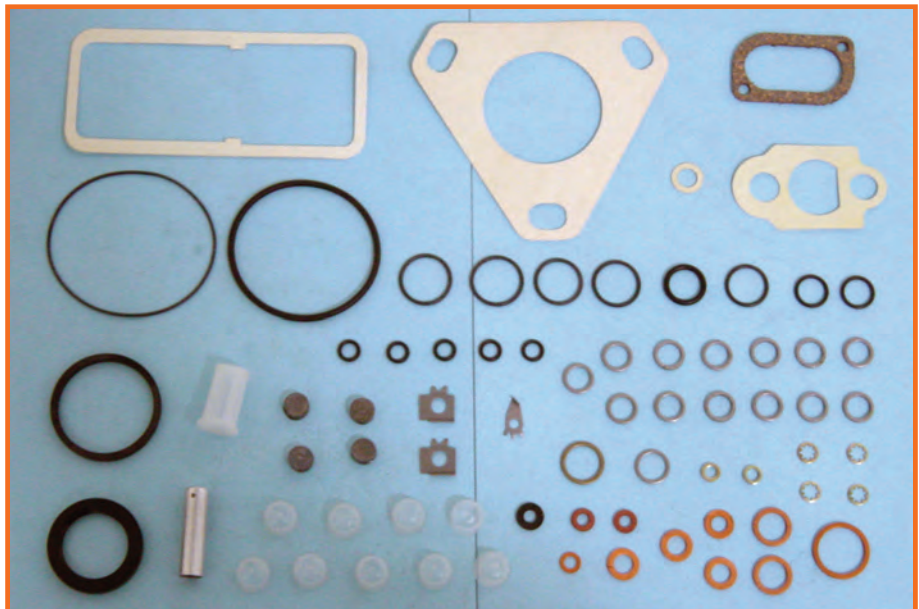

TIPO-TYPE

CODICE OMS 11-09-022/2

COD. Lucas 7135-110R

COD.

COD.

COD.

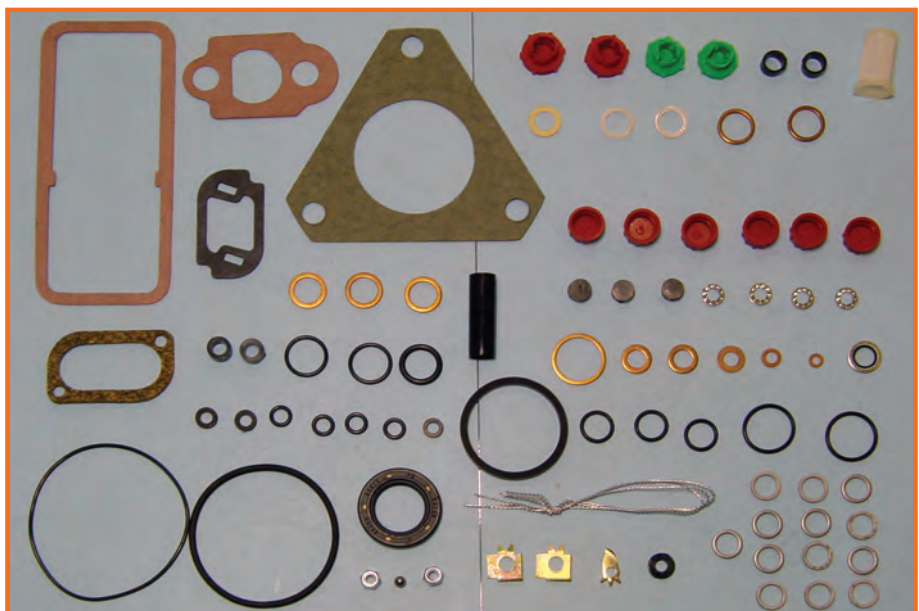

TIPO-TYPE DPA

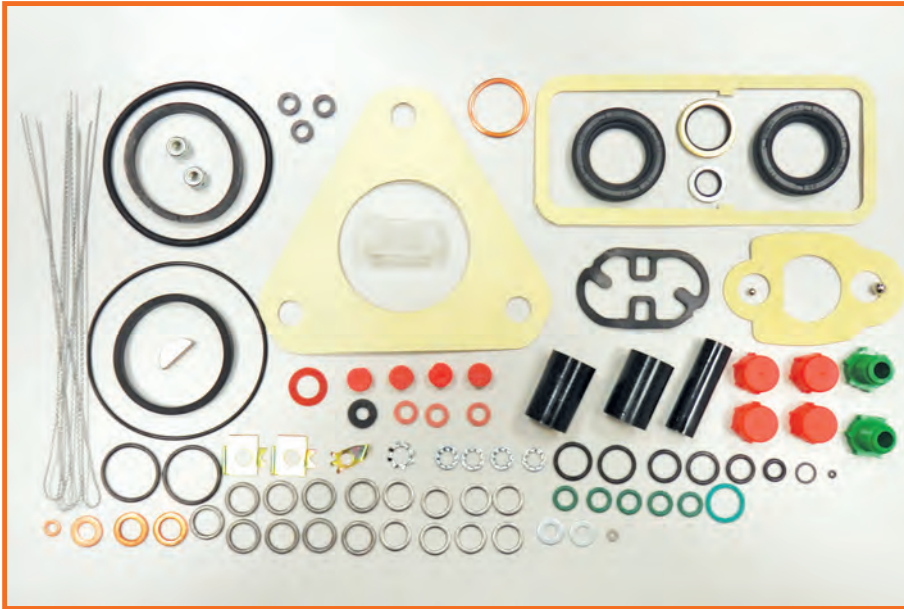

CODICE OMS 11-09-023

COD. Lucas 7135-113

COD.

COD.

COD.

TIPO-TYPE DPA

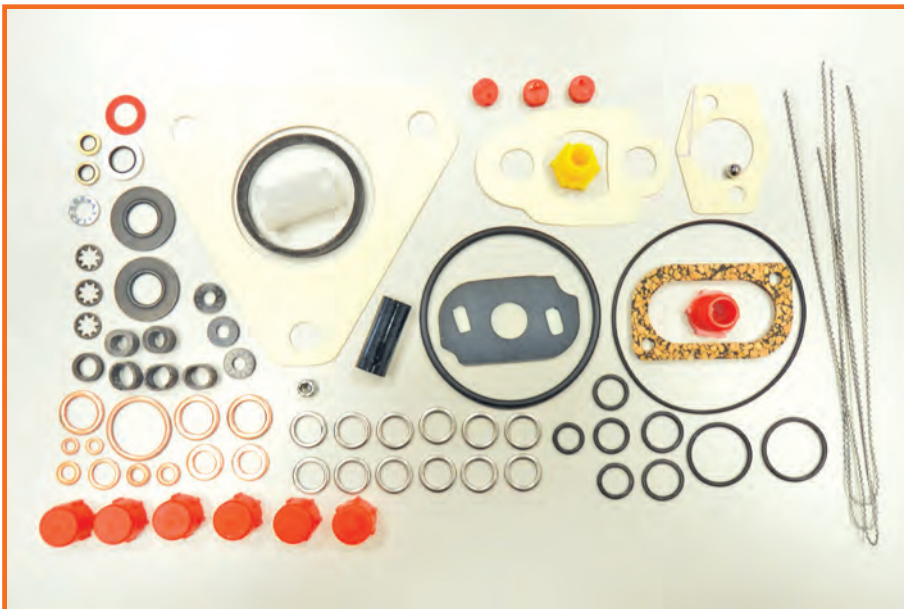

CODICE OMS 11-09-024

COD. Lucas 7135-68

COD. Lucas 7135-114

COD.

COD.

TIPO-TYPE DPA

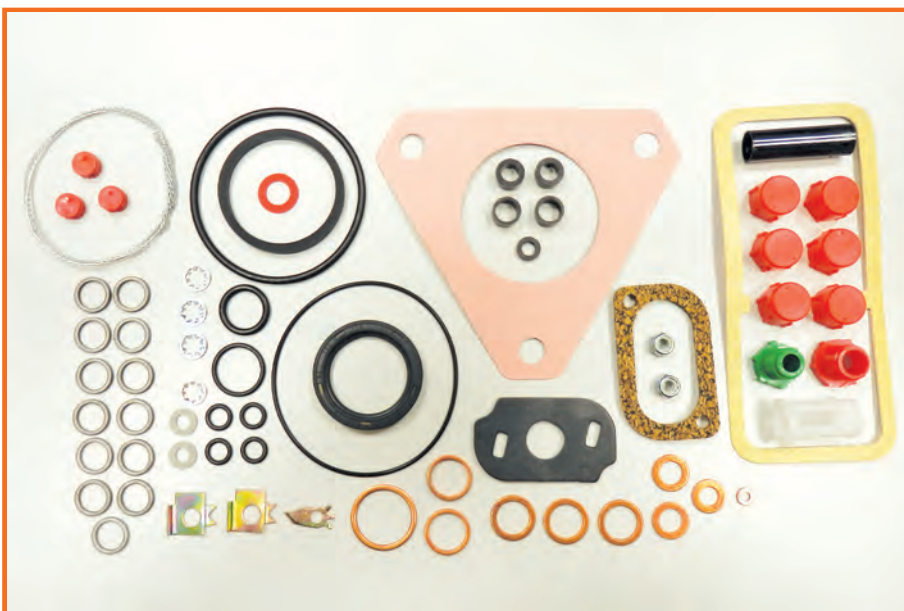

CODICE OMS 11-09-025

COD. Lucas 7135-111

COD.

COD.

COD.

TIPO-TYPE DPA



CODICE OMS 11-09-026

COD. Lucas 7135-110S

COD. Lucas 7135-258

COD.

COD.

TIPO-TYPE DPA

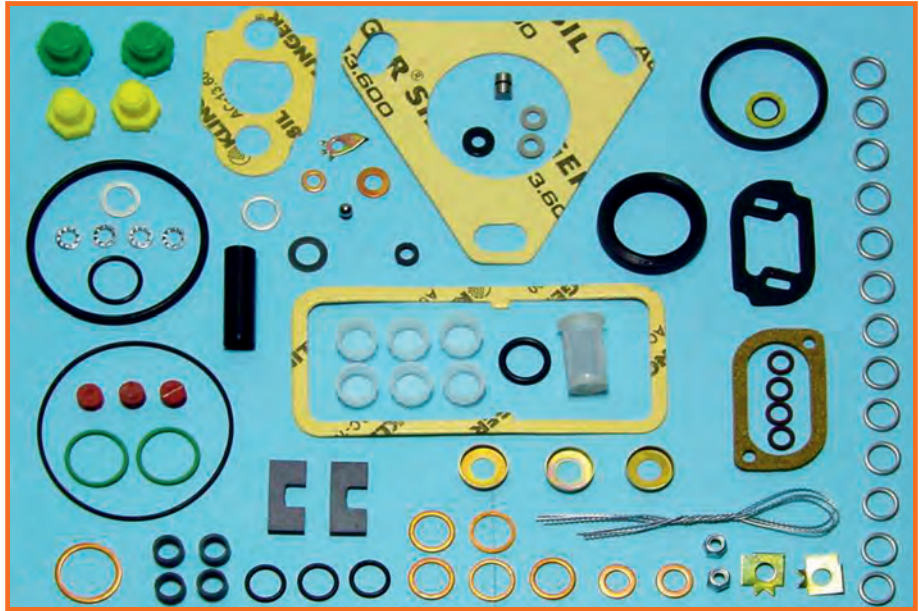

CODICE OMS 11-09-026/1

COD. Lucas 7135-110RS

COD.

COD.

COD.

TIPO-TYPE DPA

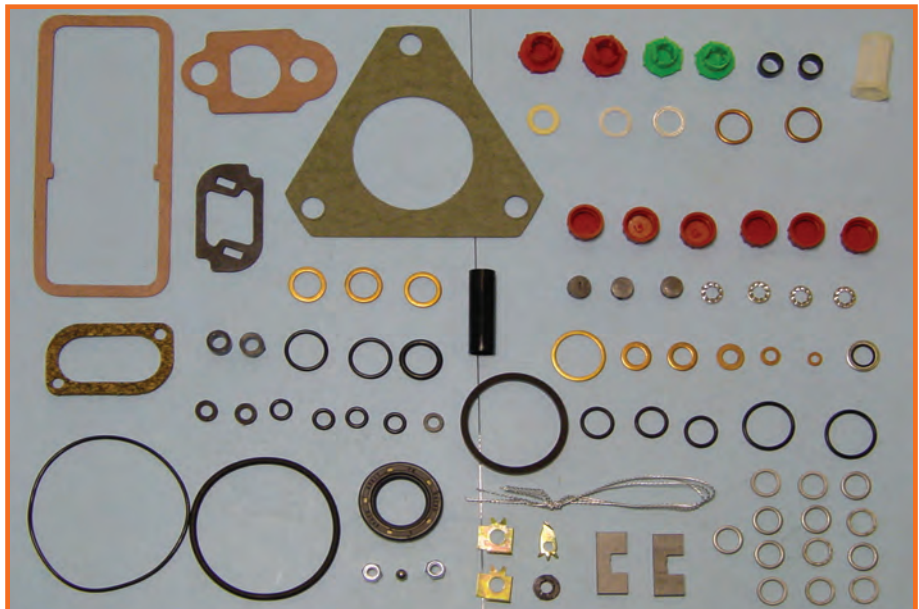

CODICE OMS 11-09-027

COD. Lucas 7135-68S

COD.

COD.

COD.

TIPO-TYPE DPA



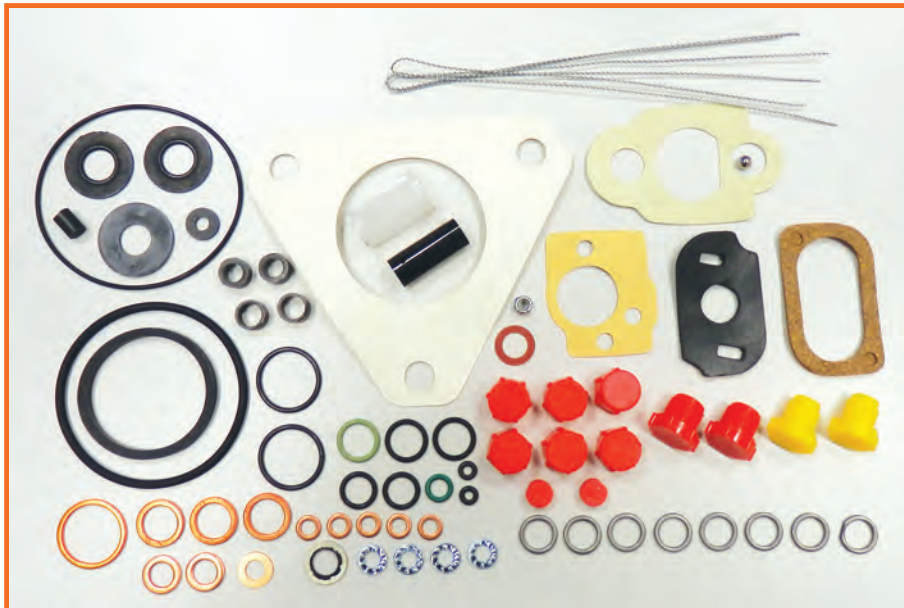

CODICE OMS 11-09-028

COD. Lucas 7135-69

COD. Lucas 7135-116

COD. Lucas 9009-088A

COD.

TIPO-TYPE DPA



CODICE OMS 11-09-029

COD. Lucas 7135-112

COD.

COD.

COD.

TIPO-TYPE DPA



CODICE OMS 11-09-030

COD. Lucas 7135-122

COD. Fiat 79071796

COD.

COD.

TIPO-TYPE DPS-FIAT TRAX



CODICE OMS 11-09-031

COD. Lucas 9109-220

COD.

COD.

COD.



TIPO-TYPE DPC

CODICE OMS 11-09-031/1

COD. Lucas 9109-220

COD.

COD.

COD.

Con 2 paraoli

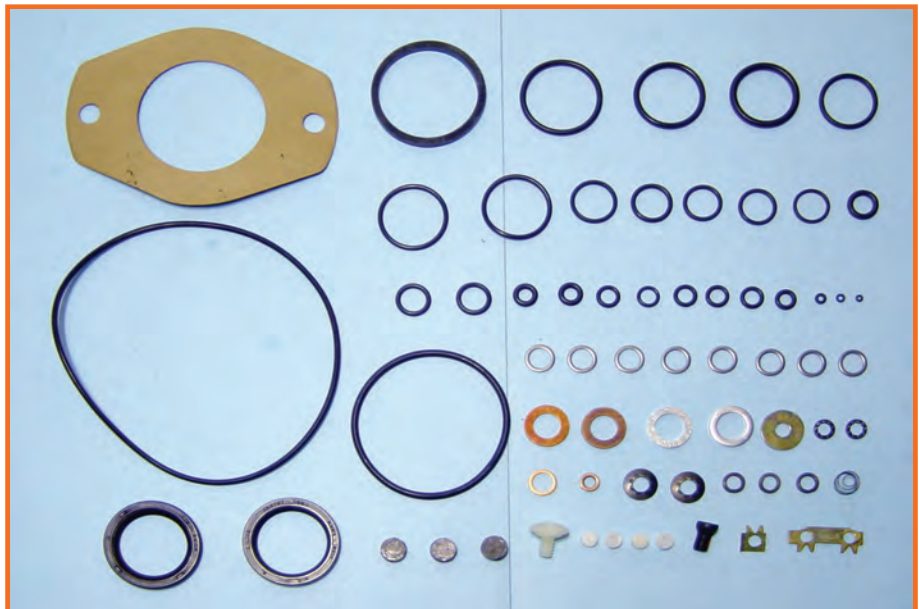

TIPO-TYPE DPC

CODICE OMS 11-09-032

COD. Lucas 9109-013A

COD. Lucas 9109-230

COD.

COD.

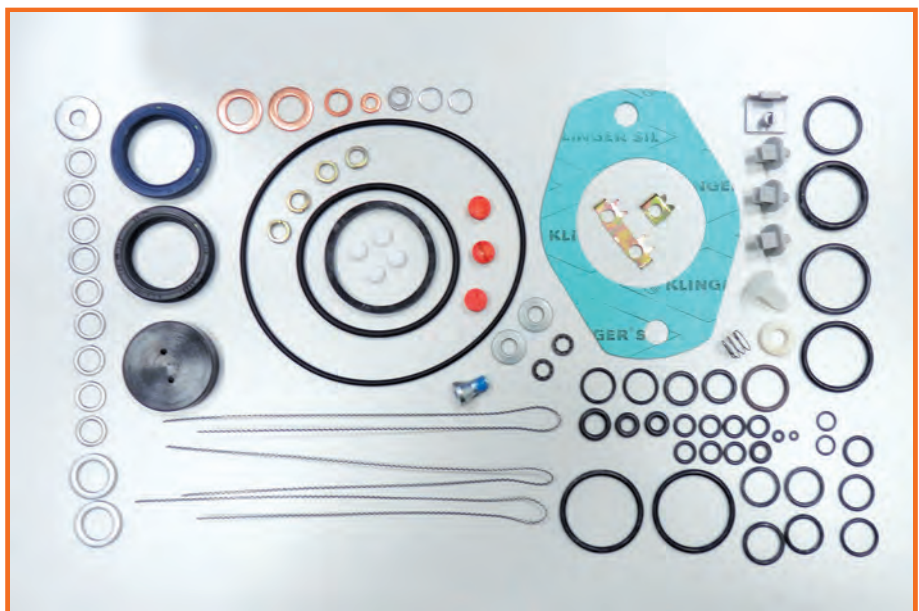

TIPO-TYPE DPC

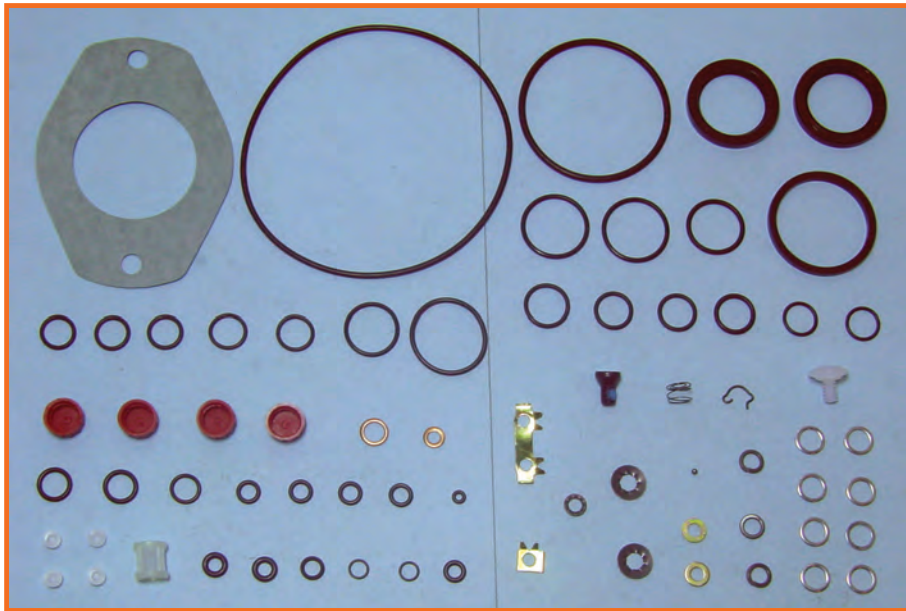

CODICE OMS 11-09-032/1

COD. Lucas 9109-013A

COD.

COD.

COD.

TIPO-TYPE DPC



CODICE OMS 11-09-033

COD. Lucas 9109-600

COD.

COD.

COD.

TIPO-TYPE DPC

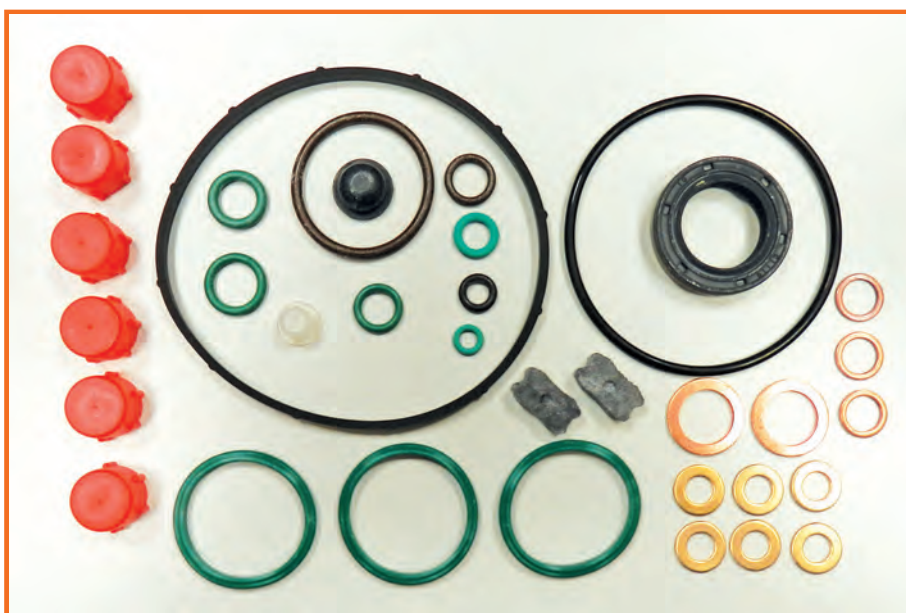

CODICE OMS 11-09-034

COD. Lucas 7135-171

COD.

COD.

COD.

TIPO-TYPE VA / VE



CODICE OMS 11-09-035

COD. Lucas 9109-210

COD.

COD.

COD.

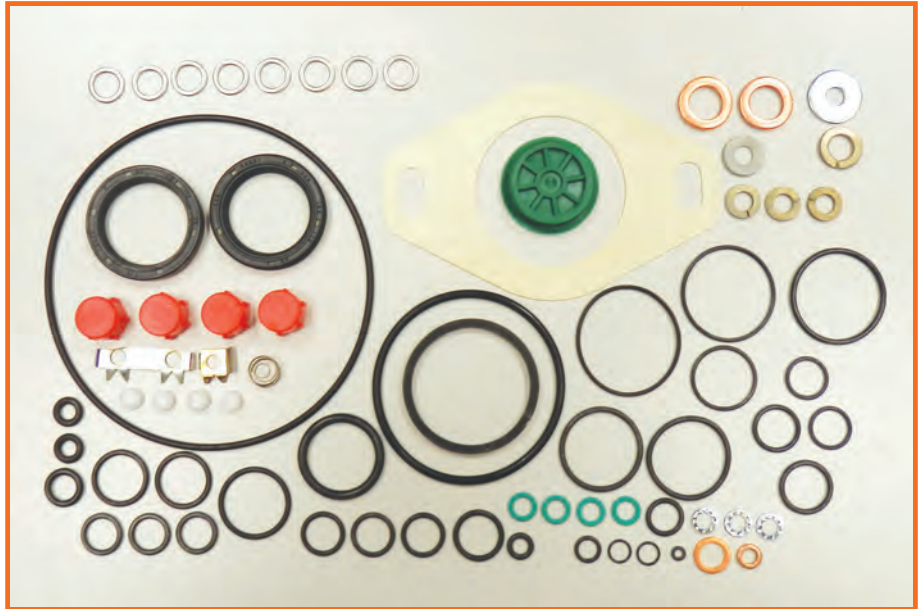

TIPO-TYPE DPC TURBO

CODICE OMS 11-09-036

COD. Lucas 9109-230A

COD.

COD.

COD.

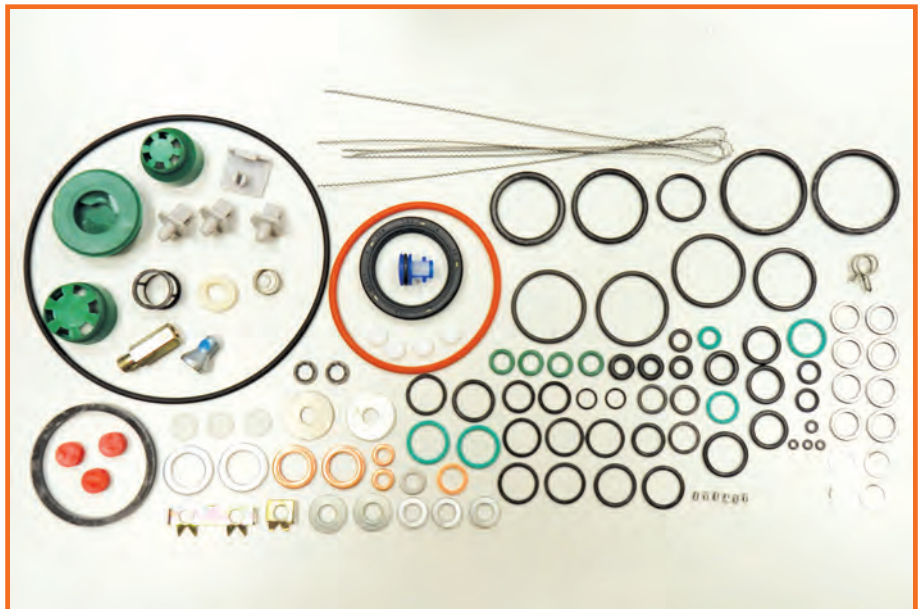

TIPO-TYPE X ASPIRATO

CODICE OMS 11-09-037

COD. Lucas 7135-68

COD.

COD.

COD.

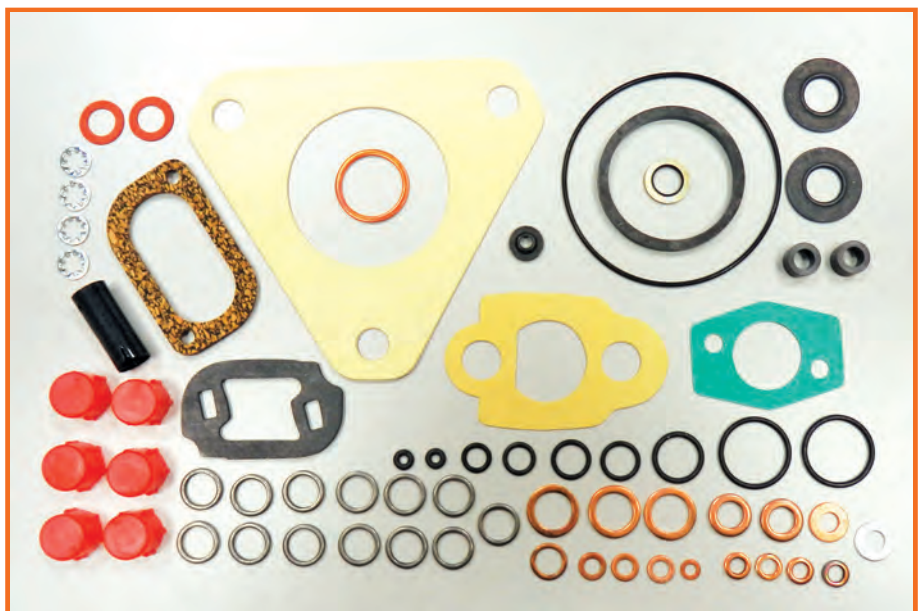

TIPO-TYPE

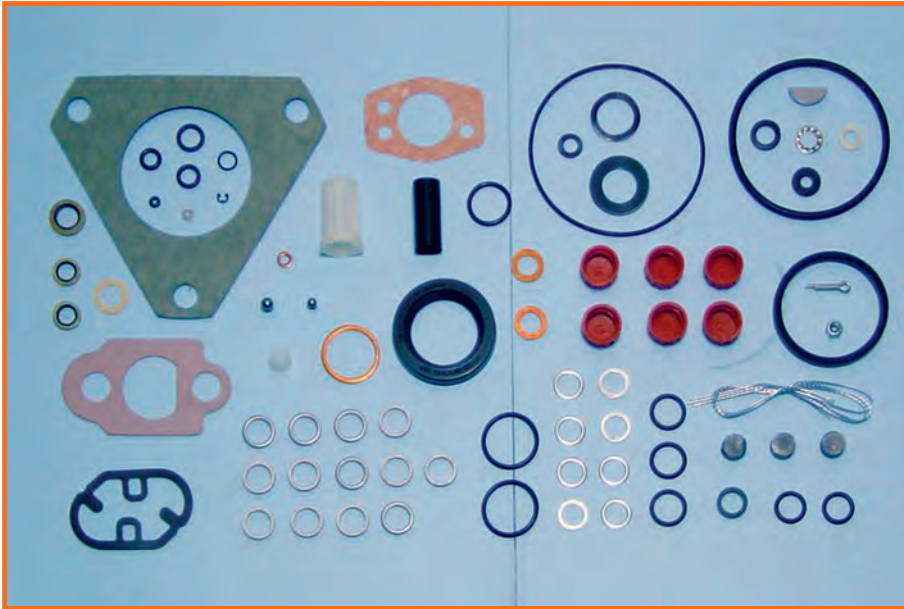

CODICE OMS 11-09-039

COD. Lucas 7135-68A

COD. Lucas 7135-117

COD.

COD.

TIPO-TYPE DPA

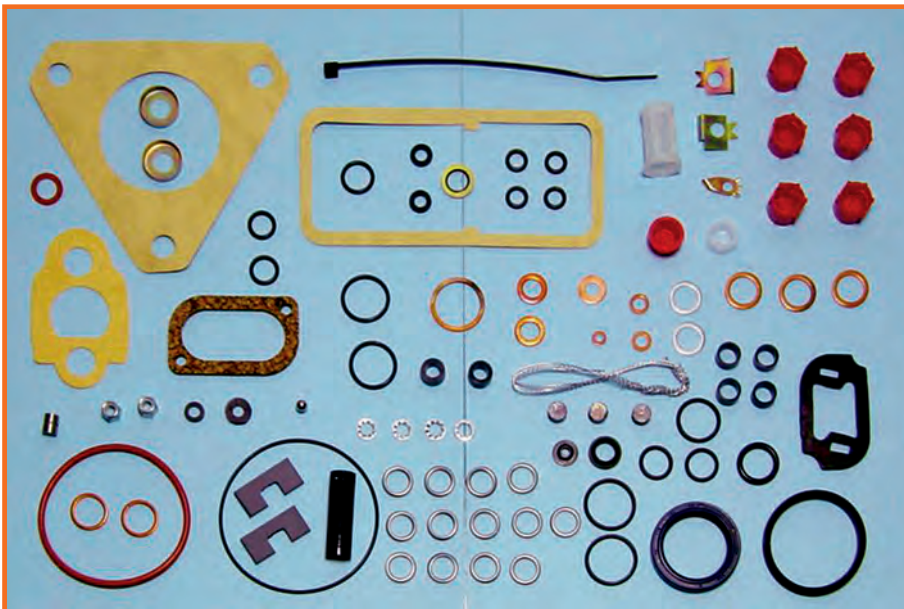

CODICE OMS 11-09-040

COD. Lucas 7135-70S

COD.

COD.

COD.

TIPO-TYPE DPA

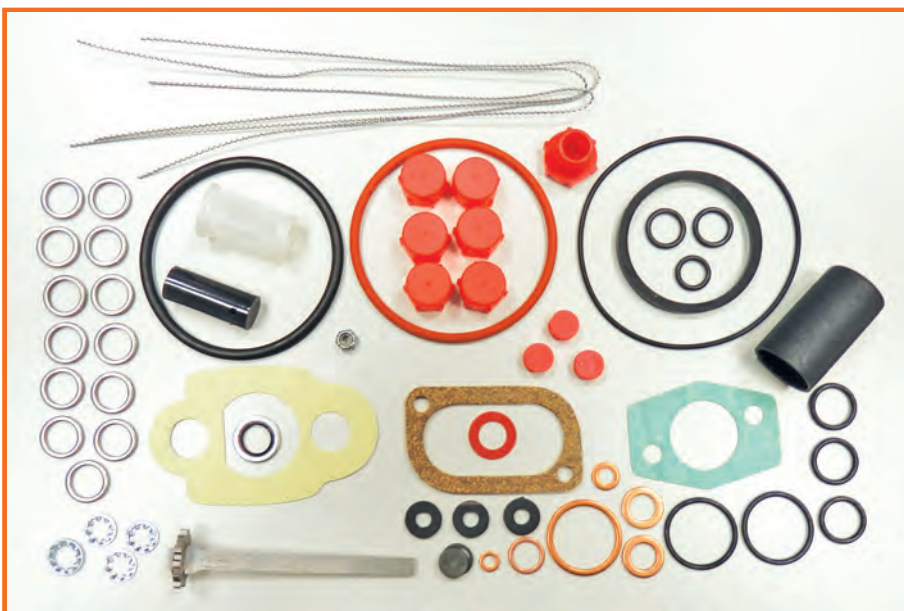

CODICE OMS 11-09-045

COD. Lucas 7135-115

COD.

COD.

COD.

TIPO-TYPE DPA



CODICE OMS 11-09-047

COD. Lucas 7135-118

COD.

COD.

COD.

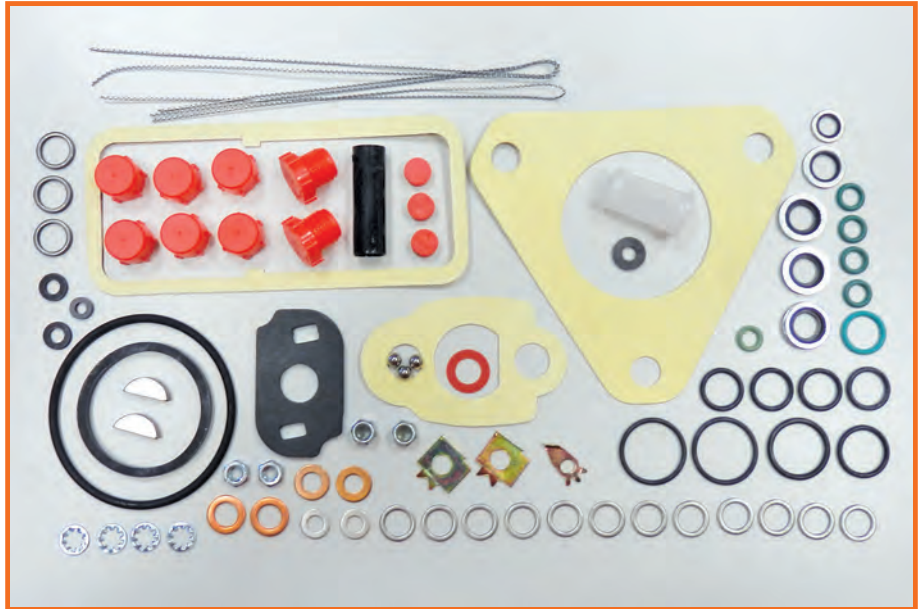

TIPO-TYPE DPA

CODICE OMS 11-09-048

COD. Lucas 7135-120

COD.

COD.

COD.

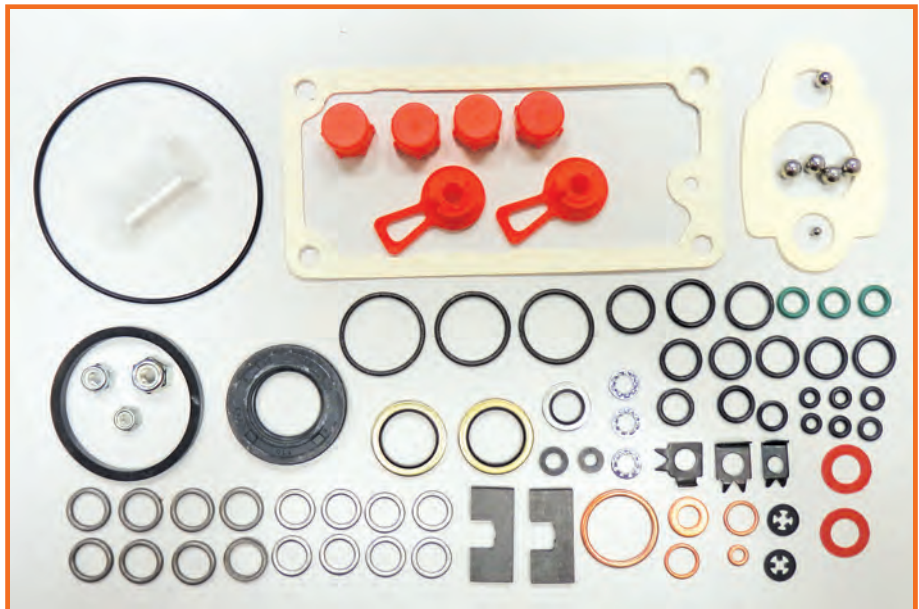

TIPO-TYPE DPS

CODICE OMS 11-09-053

COD. Lucas 7135-167

COD. GK 268

COD.

COD.

Con regolatore meccanico RSF

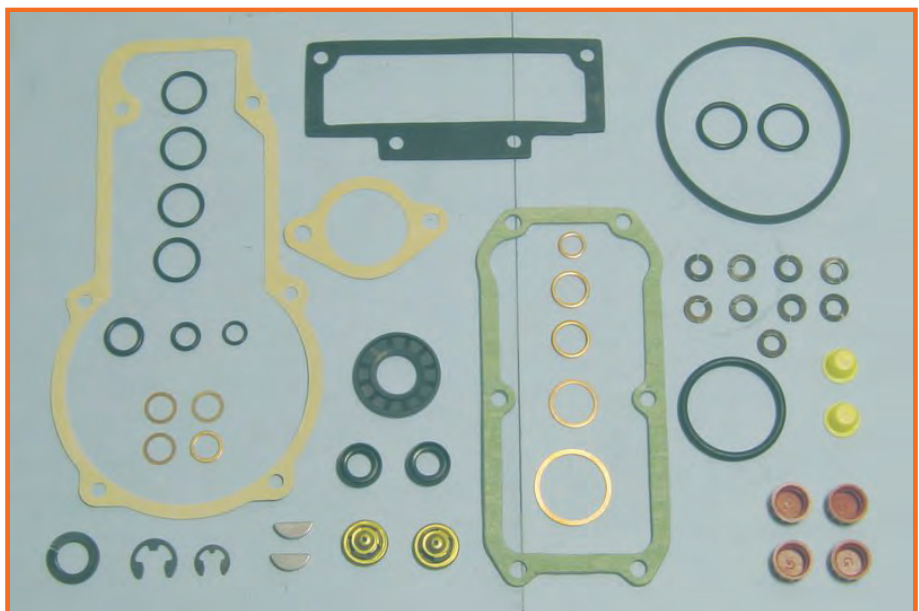

TIPO-TYPE PES..4M..

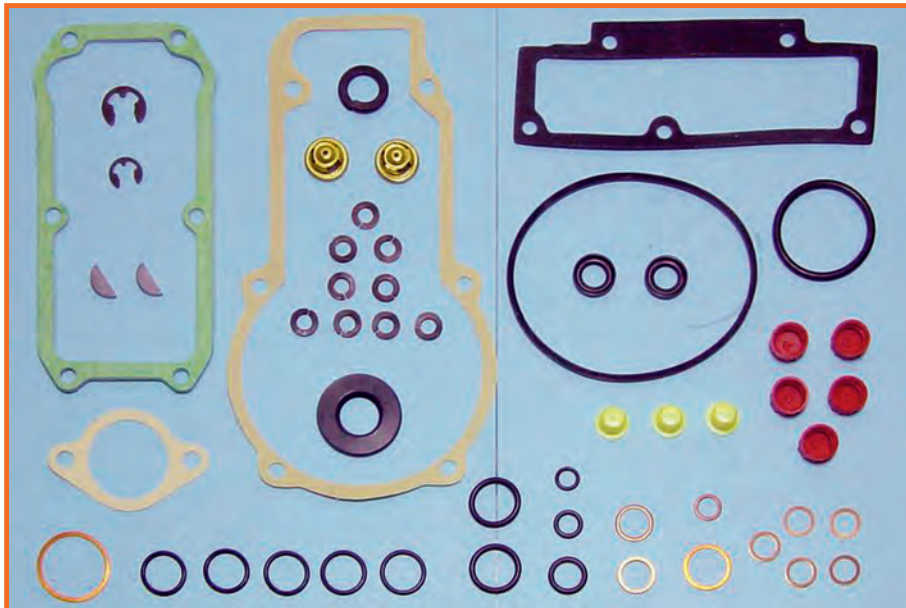

CODICE OMS 11-09-054

COD. Lucas 7135-168

COD. GK 269

COD.

COD.

TIPO-TYPE PES 5M...C...S 1



CODICE OMS 11-09-058

COD. Stanadyne 24370

COD.

COD.

COD.

TIPO-TYPE BD 2

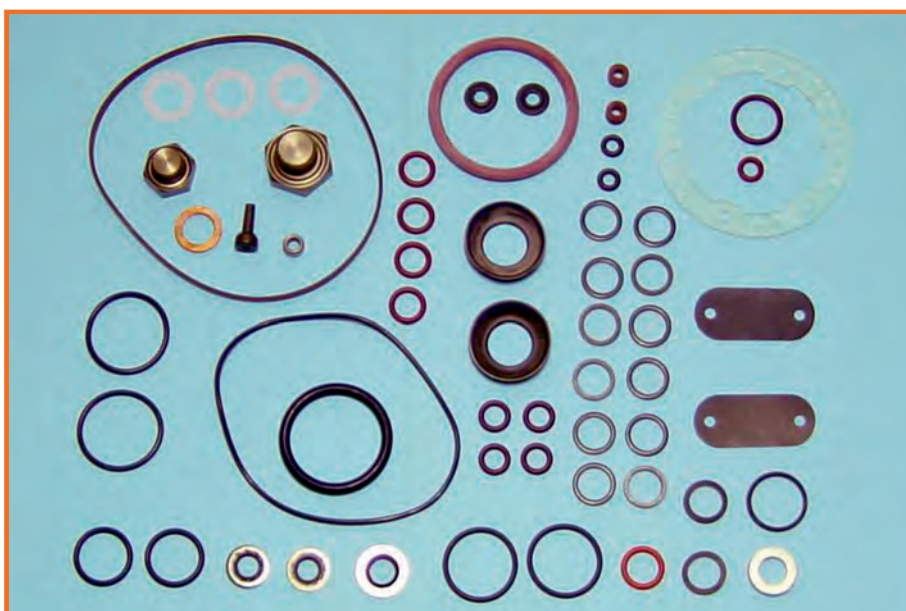

CODICE OMS 11-09-059

COD. Stanadyne 24371

COD.

COD.

COD.

TIPO-TYPE RM DB



CODICE OMS 11-09-060

COD. Stanadyne 24373

COD.

COD.

COD.



TIPO-TYPE RM DB2 AGRIC

CODICE OMS 11-09-061

COD. Simms 506805

COD.

COD.

COD.

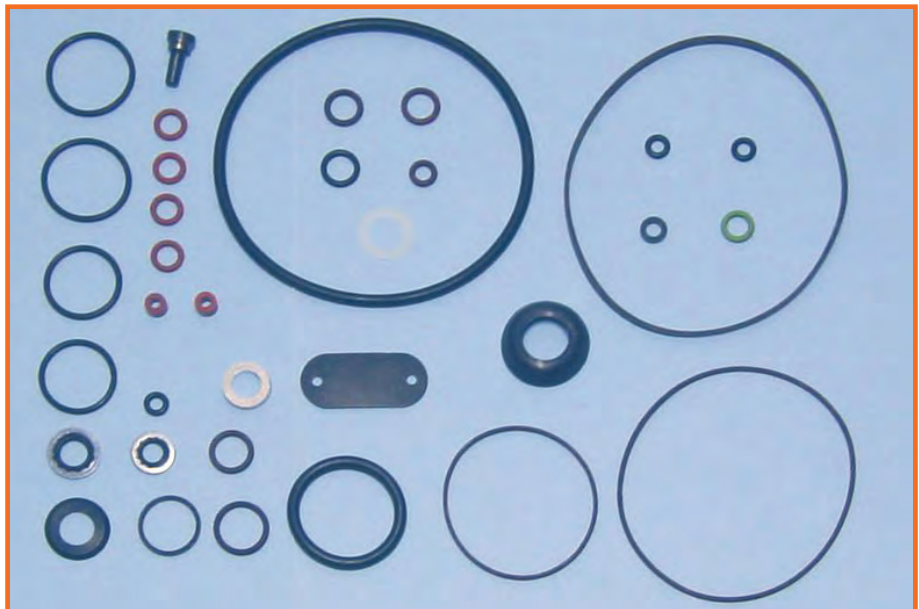

TIPO-TYPE SP GE...3

CODICE OMS 11-09-062

COD. Simms 506801

COD.

COD.

COD.

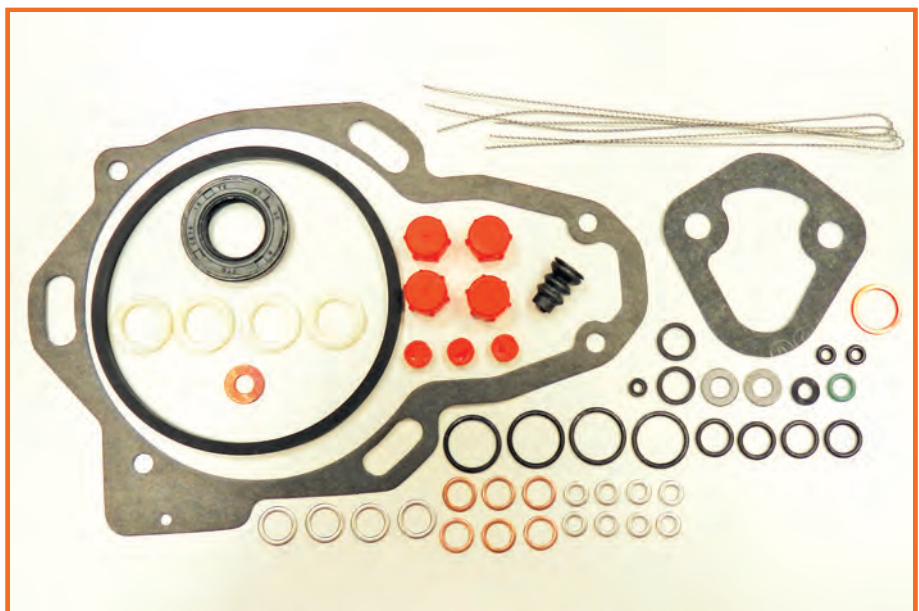

TIPO-TYPE SP GE...4A MINIMEC

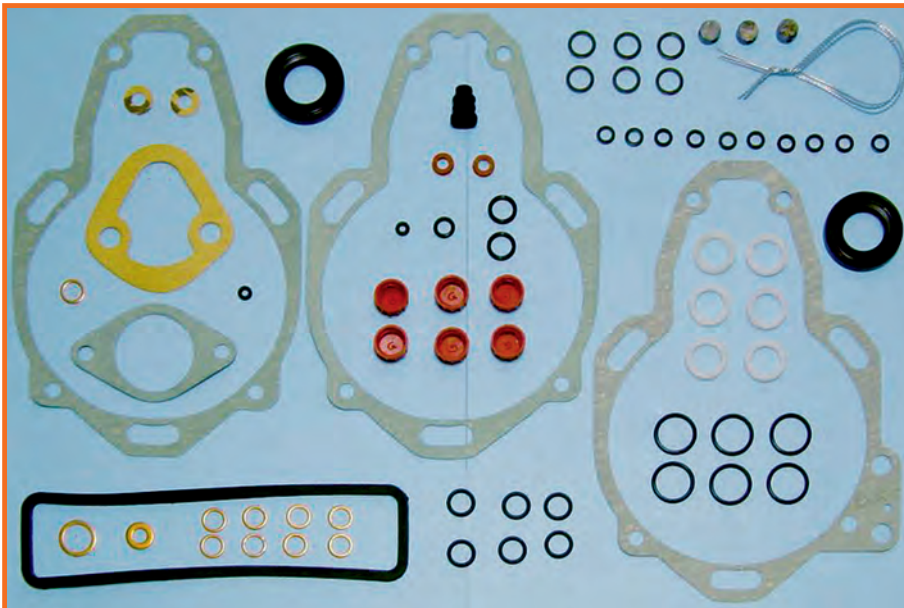

CODICE OMS 11-09-063

COD. Simms 506807

COD.

COD.

COD.

TIPO-TYPE SP GE...6A

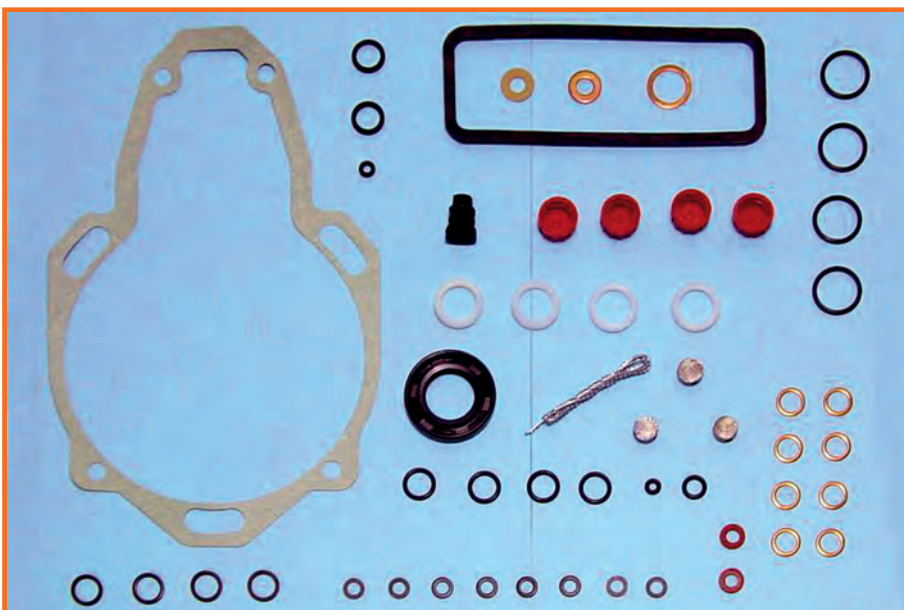

CODICE OMS 11-09-064

COD. Simms 506802

COD.

COD.

COD.

TIPO-TYPE SP GE...4A

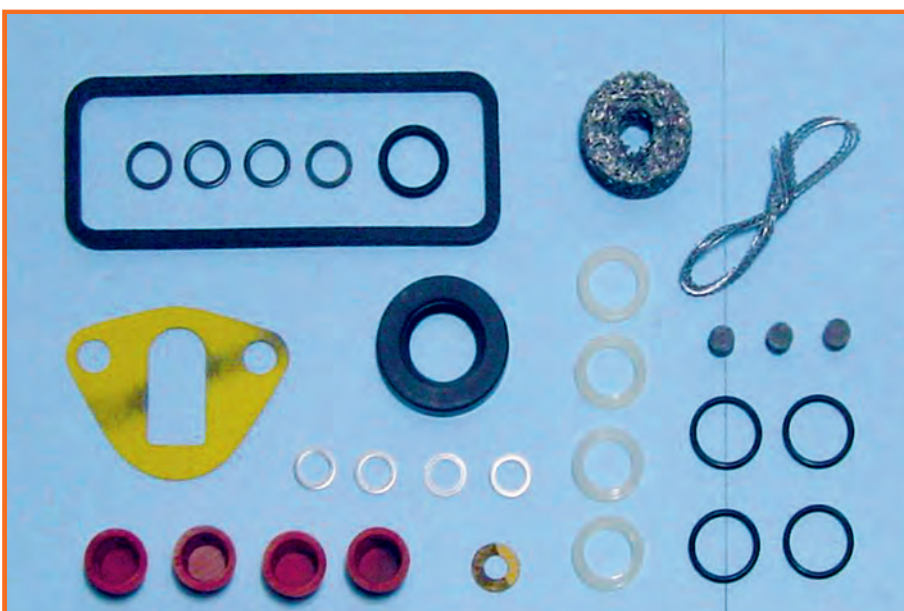

CODICE OMS 11-09-065

COD. Simms 506803

COD.

COD.

COD.

TIPO-TYPE SP GE...4A



CODICE OMS 11-09-066

COD. Simms 506808

COD.

COD.

COD.

TIPO-TYPE SP GE...6A

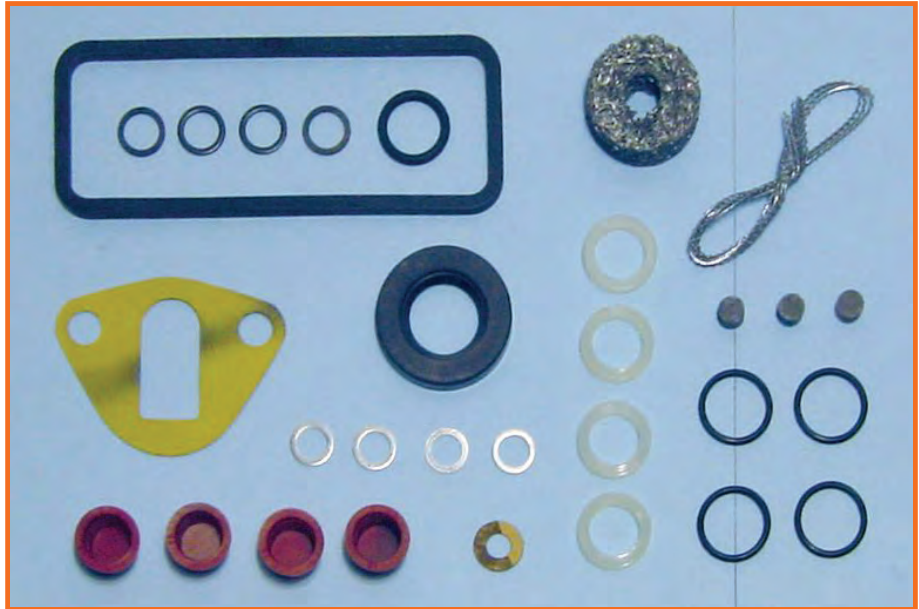

CODICE OMS 11-09-067

COD. Ambac KT 76479

COD.

COD.

COD.

TIPO-TYPE APE



CODICE OMS 11-09-069

COD. Caterpillar 6N1133

COD.

COD.

COD.

TIPO-TYPE

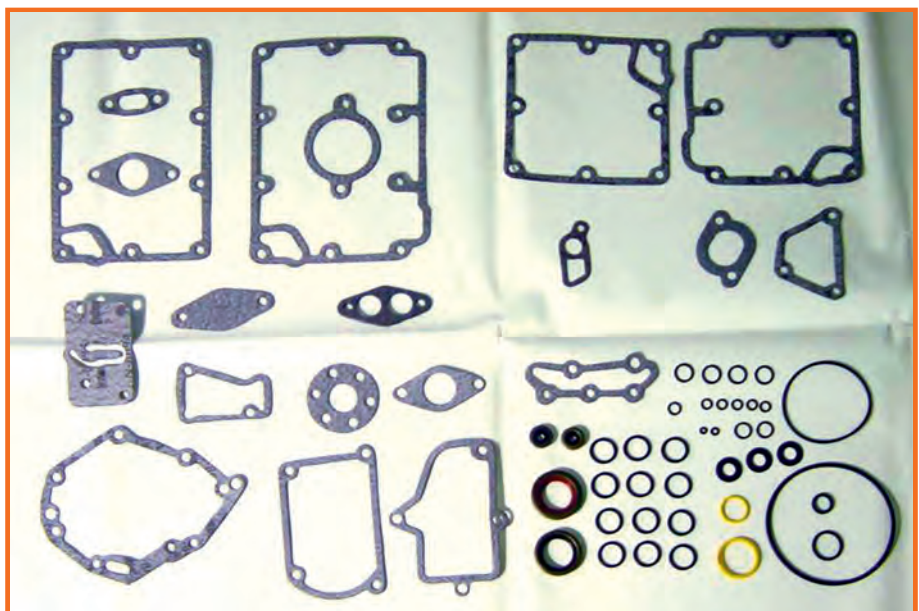

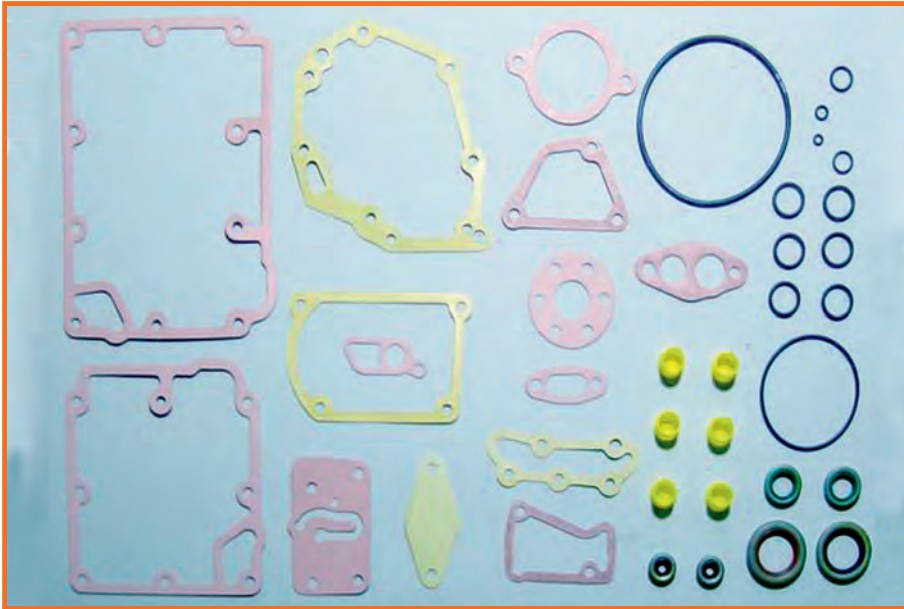

CODICE OMS 11-09-069/1

COD. Caterpillar 6N1133

COD.

COD.

COD.

TIPO-TYPE

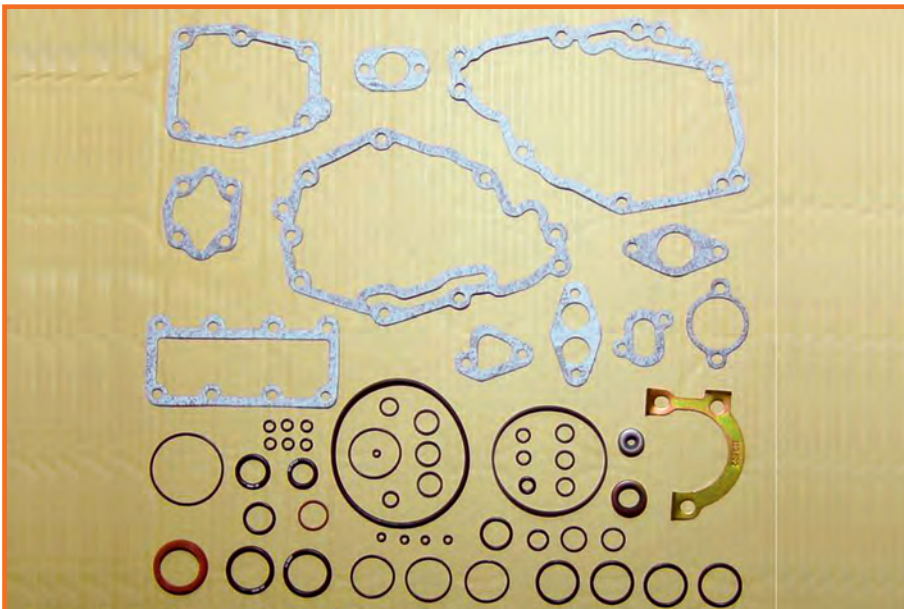

CODICE OMS 11-09-070

COD. Caterpillar 6V4780

COD.

COD.

COD.

TIPO-TYPE EP VA

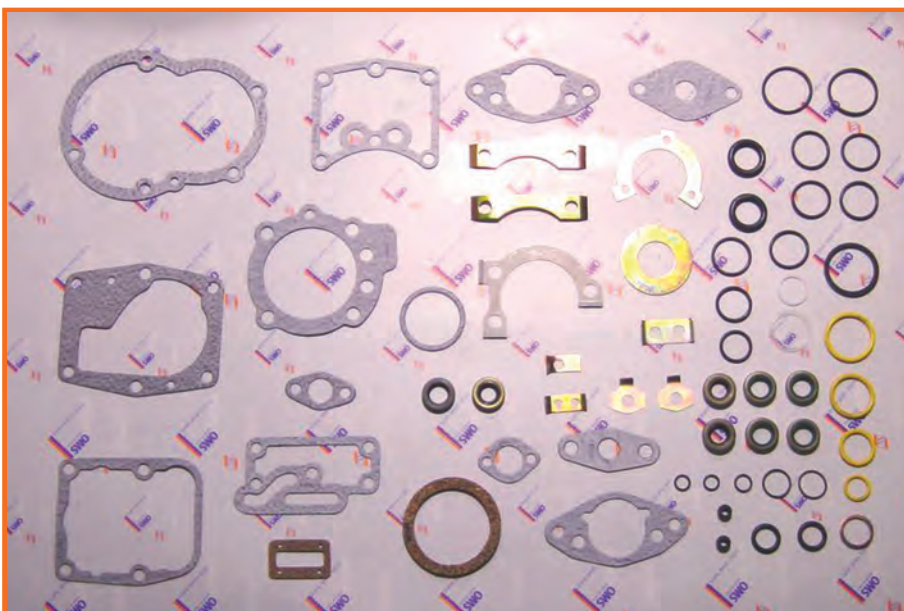

CODICE OMS 11-09-071

COD. Caterpillar 6V2414

COD.

COD.

COD.

TIPO-TYPE



CODICE OMS 11-09-071/1

COD. Caterpillar 6V2414
 COD.
 COD.
 COD.

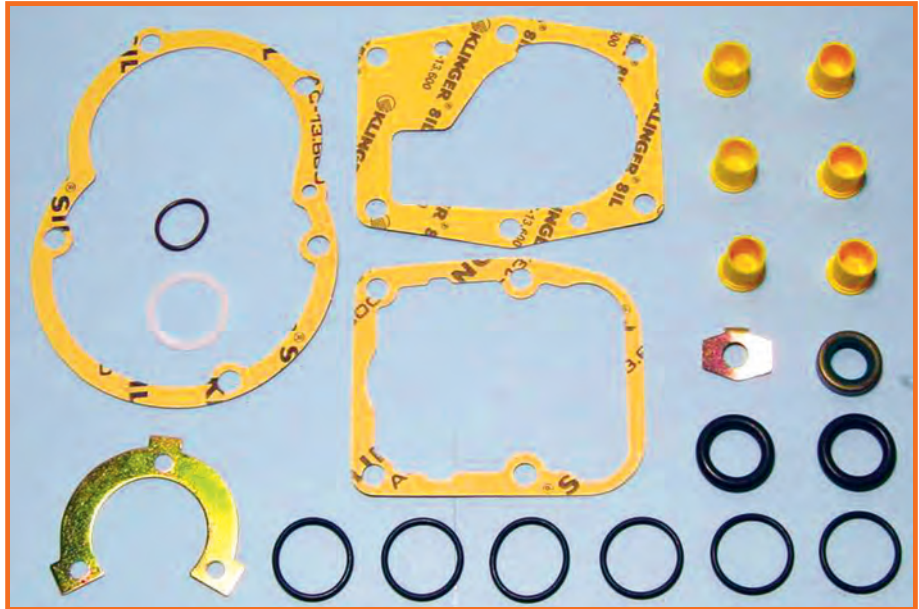

TIPO-TYPE

CODICE OMS 11-09-072

COD. Caterpillar 6V2909
 COD.
 COD.
 COD.

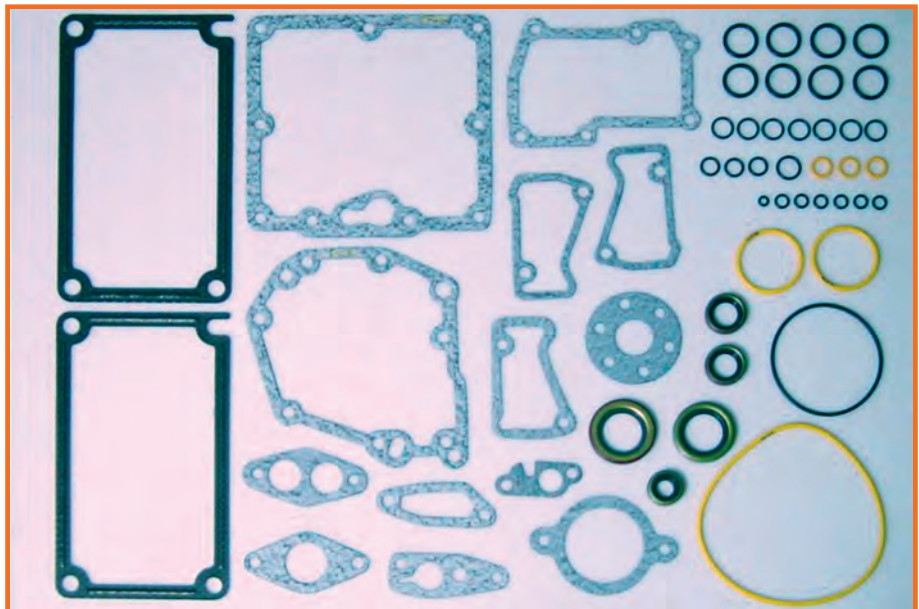

TIPO-TYPE

CODICE OMS 11-09-073

COD. Caterpillar 6V4707
 COD.
 COD.
 COD.

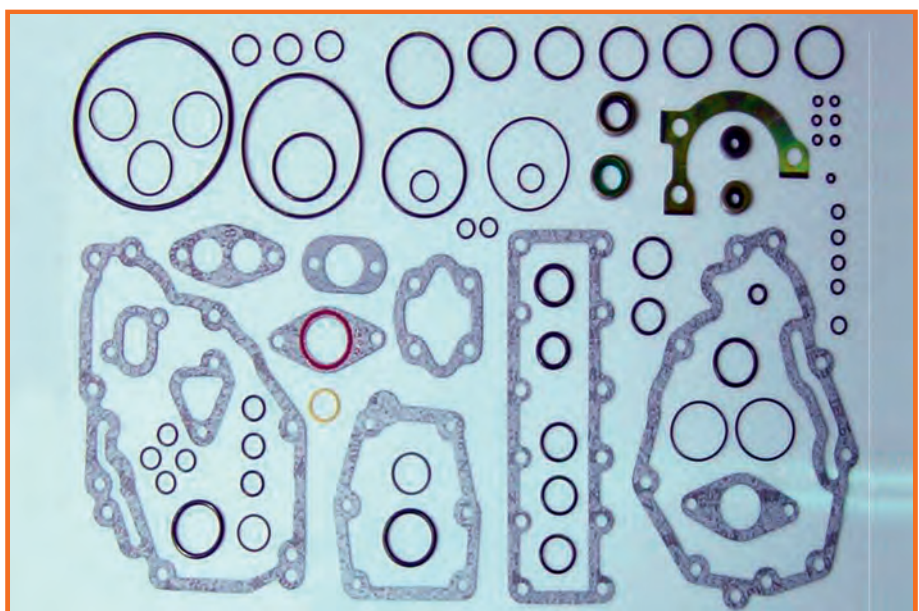

TIPO-TYPE

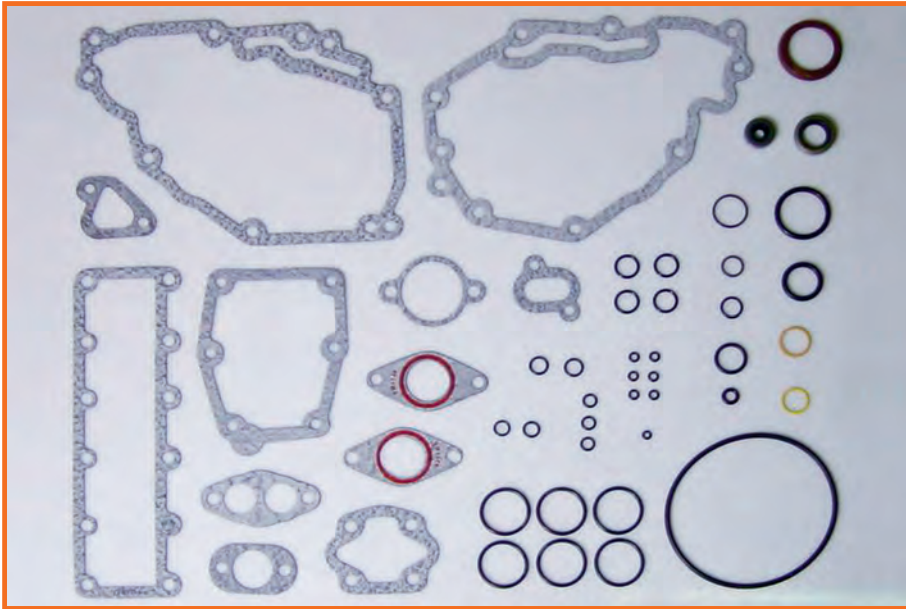

CODICE OMS 11-09-074

COD. Caterpillar 8T1653

COD.

COD.

COD.

TIPO-TYPE



CODICE OMS 11-09-075

COD. Lucas 9109-181

COD.

COD.

COD.

KIT con filtro 11-09-075/1

 14-13-026
9102-915

TIPO-TYPE DPC



CODICE OMS 11-09-076

COD. Lucas 9109-120

COD.

COD.

COD.

TIPO-TYPE Dust Cover Kit



CODICE OMS 11-09-077

COD. Lucas 9109-120A

COD.

COD.

COD.

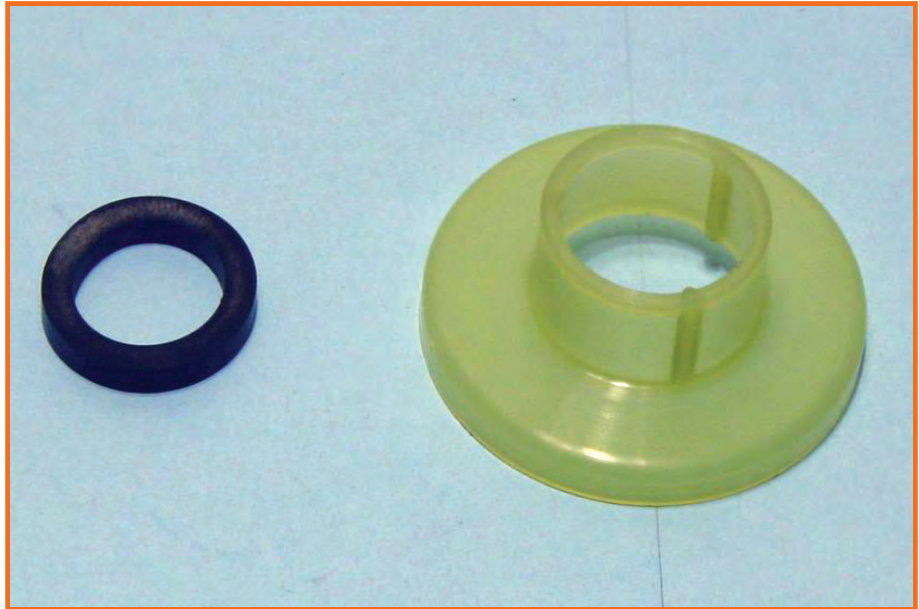

TIPO-TYPE

CODICE OMS 11-09-078

COD. Caterpillar 6V4788

COD.

COD.

COD.

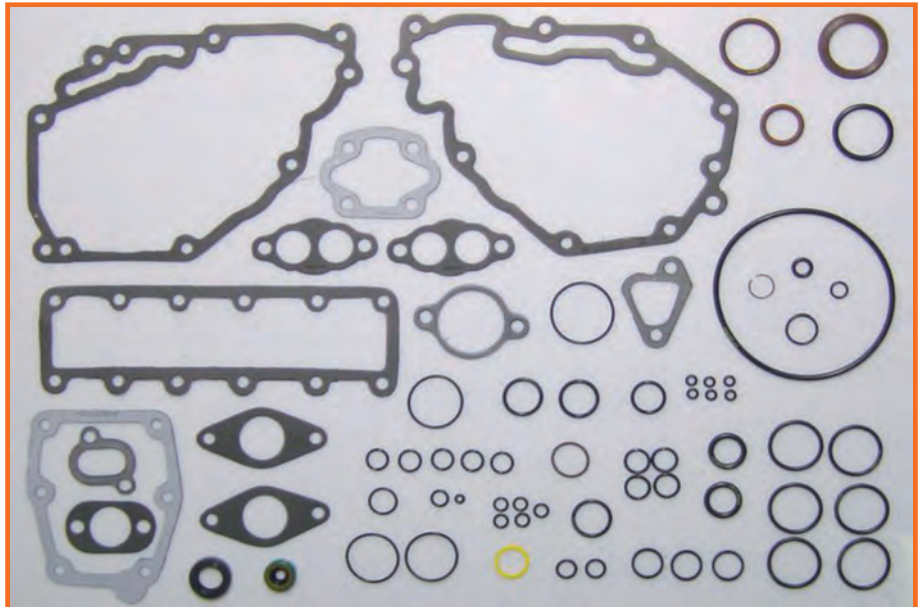

TIPO-TYPE

CODICE OMS 11-09-081

COD. Lucas 7135-227

COD.

COD.

COD.

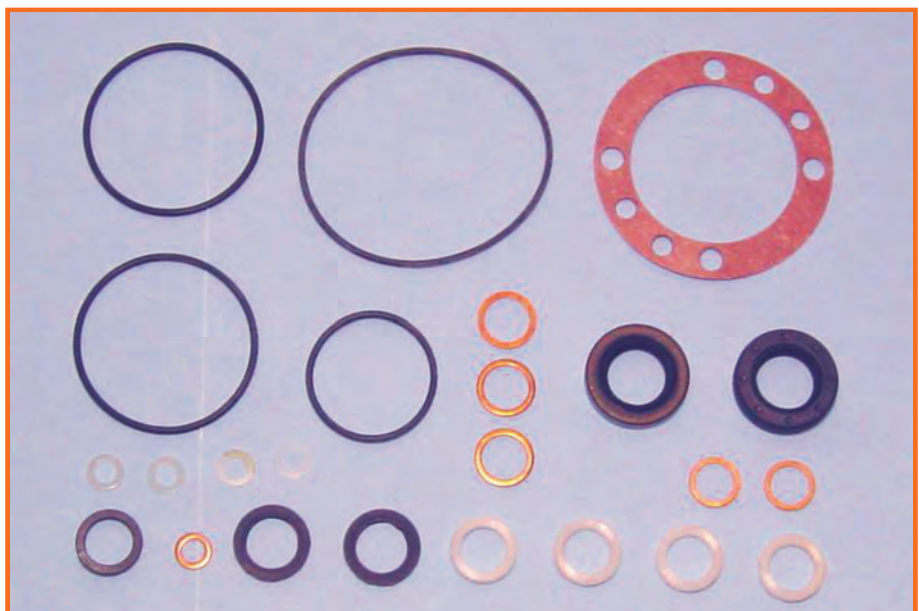

TIPO-TYPE

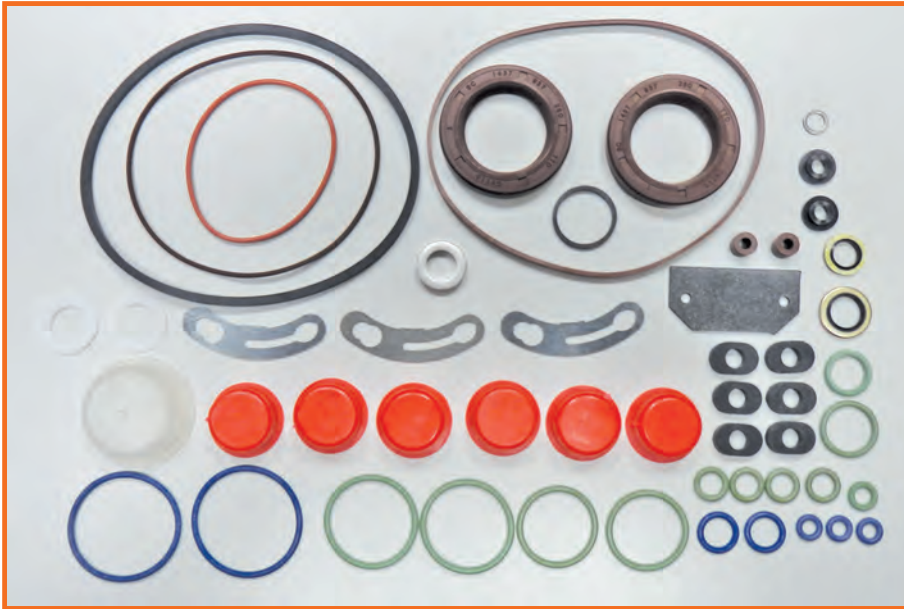

CODICE OMS 11-09-082

COD. Stanadyne 24372

COD.

COD.

COD.

TIPO-TYPE DB2



CODICE OMS 11-09-083

COD. Lucas 9109-210A

COD.

COD.

COD.

TIPO-TYPE

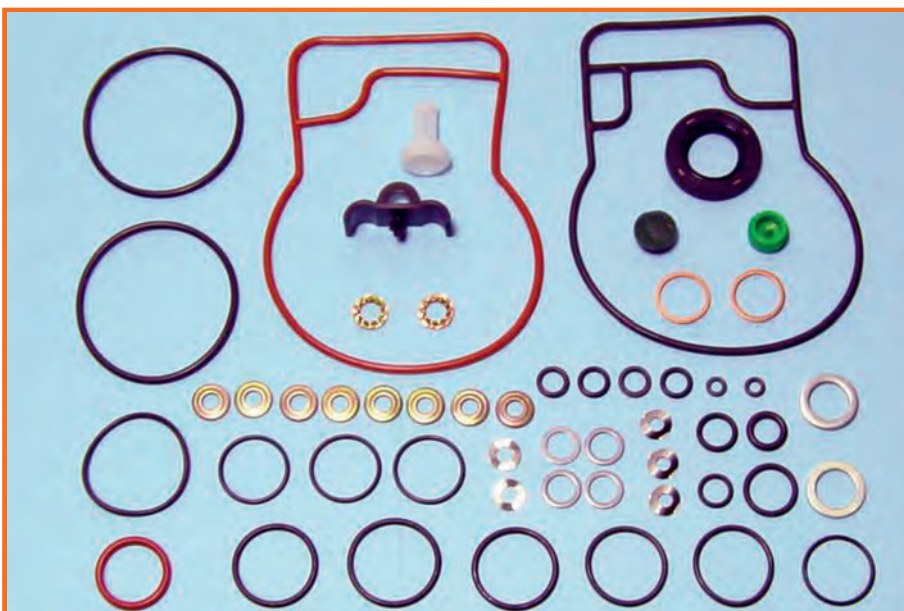

CODICE OMS 11-09-084

COD. Lucas 9109-750

COD.

COD.

COD.

TIPO-TYPE



CODICE OMS 11-09-084/1

COD. Lucas 9109-750

COD.

COD.

COD.

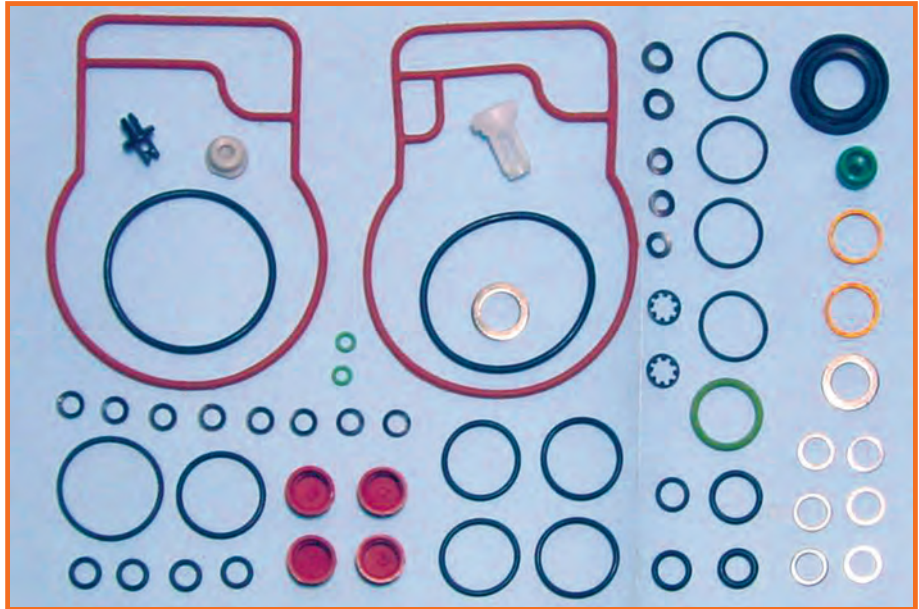

TIPO-TYPE EP-VE/LDA

CODICE OMS 11-09-085

COD. Lucas 9109-760

COD.

COD.

COD.

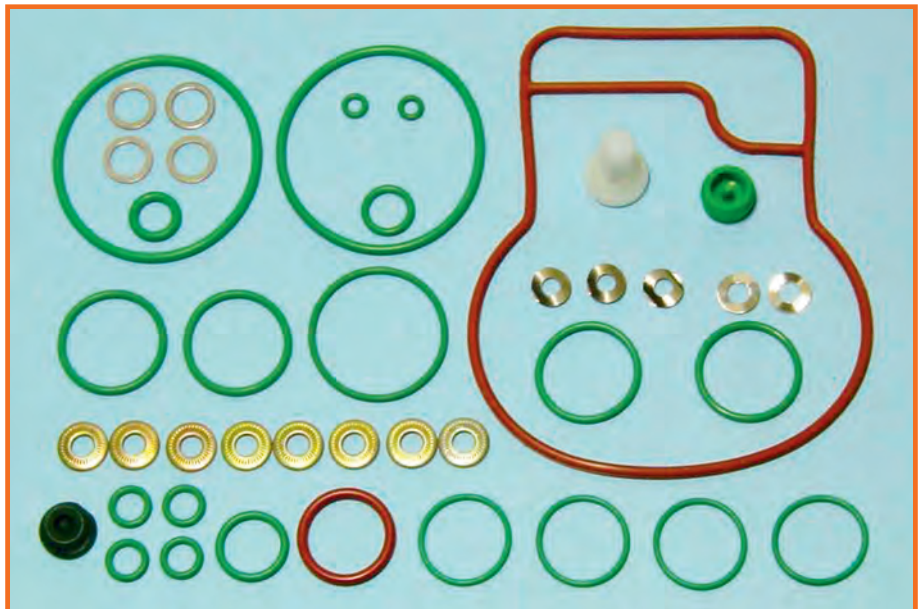

TIPO-TYPE

CODICE OMS 11-09-086

COD. Lucas 7135-277G

COD.

COD.

COD.



TIPO-TYPE

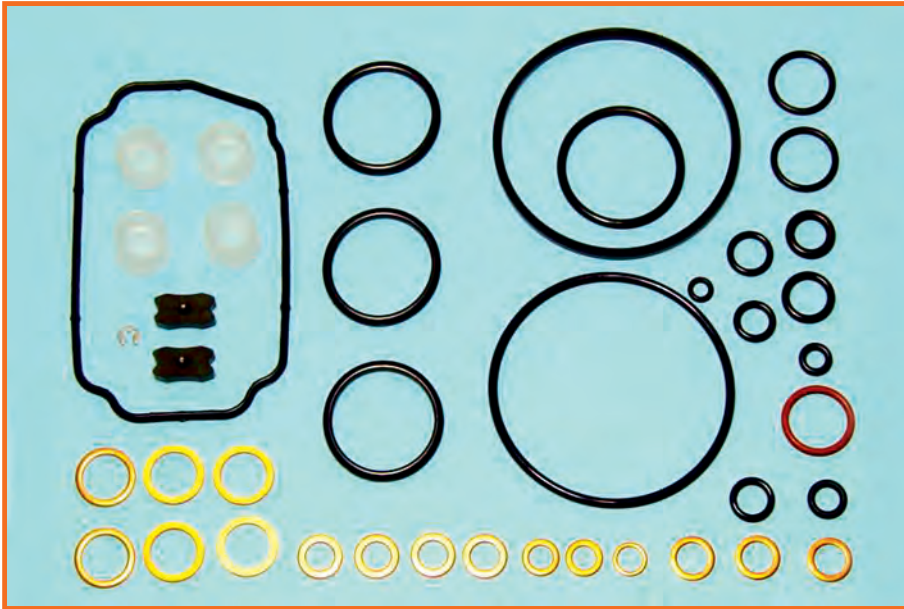

CODICE OMS 11-09-087

COD. Denso 096010-0031

COD. _____

COD. _____

COD. _____

TIPO-TYPE



CODICE OMS 11-09-088

COD. Denso 096010-0541

COD. _____

COD. _____

COD. _____

TIPO-TYPE



CODICE OMS 11-09-089

COD. Lucas 9109-220A

COD. _____

COD. _____

COD. _____

TIPO-TYPE



CODICE OMS 11-09-090

COD. Lucas 7135-277

COD.

COD.

COD.

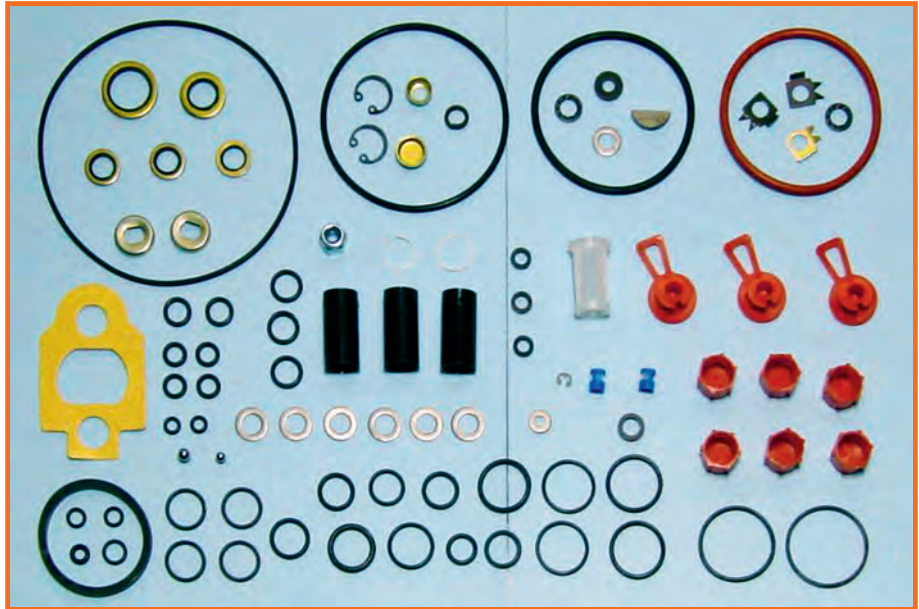

TIPO-TYPE

CODICE OMS 11-09-091

COD. Lucas 7135-277A

COD.

COD.

COD.

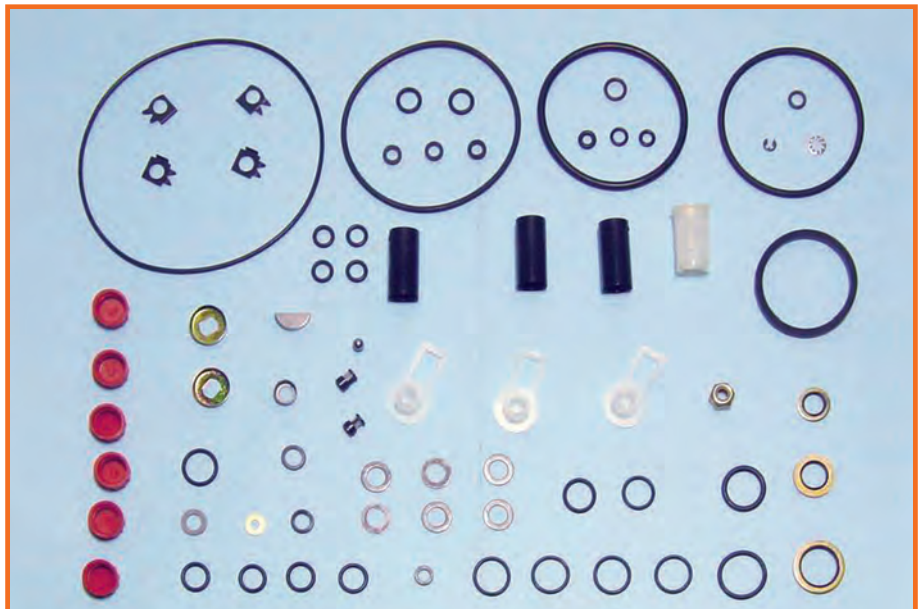

TIPO-TYPE

CODICE OMS 11-09-092

COD. Lucas 7135-277B

COD.

COD.

COD.



TIPO-TYPE

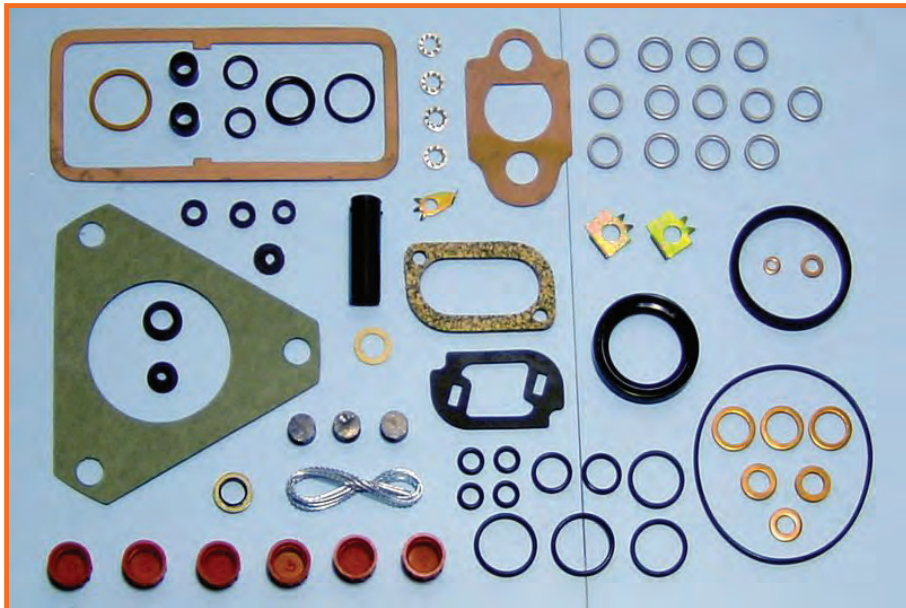

CODICE OMS 11-09-093

COD. Lucas 7135-70

COD.

COD.

COD.

TIPO-TYPE

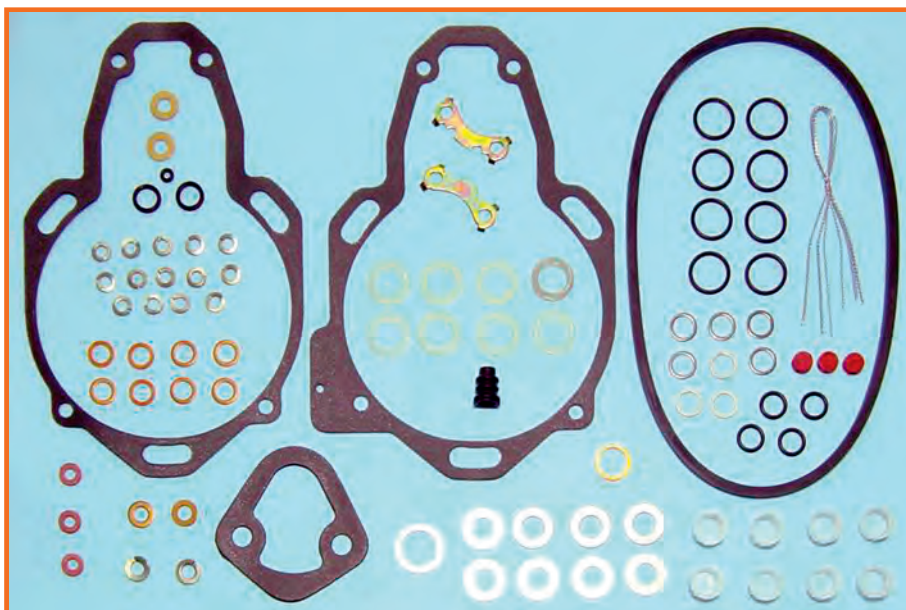

CODICE OMS 11-09-094

COD. Simms 506809

COD. Simms 506810

COD.

COD.

TIPO-TYPE 8 cil. MINIMEC

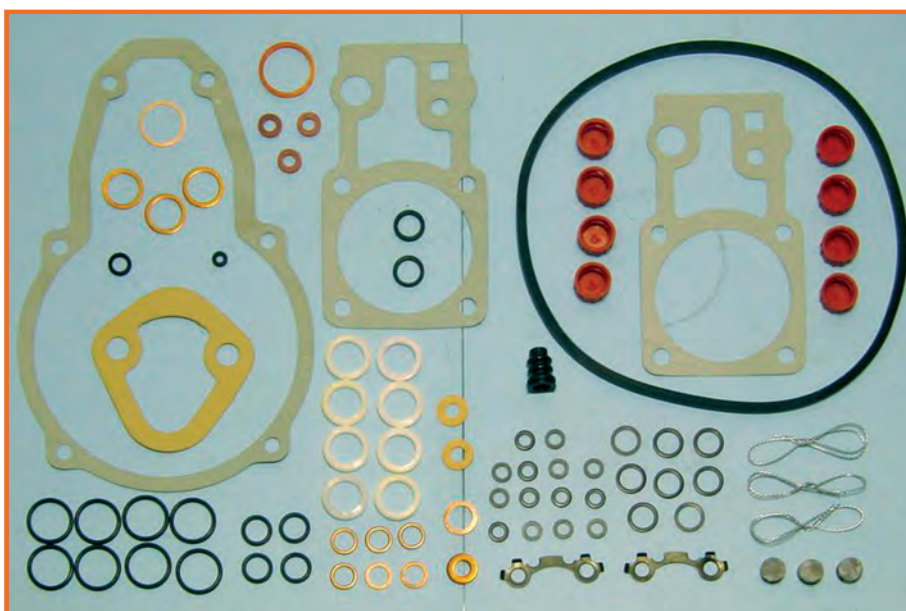

CODICE OMS 11-09-094/1

COD. Simms 506810

COD.

COD.

COD.

8 Cilindri

TIPO-TYPE



CODICE OMS 11-09-095

COD. Lucas 7135-127

COD.

COD.

COD.

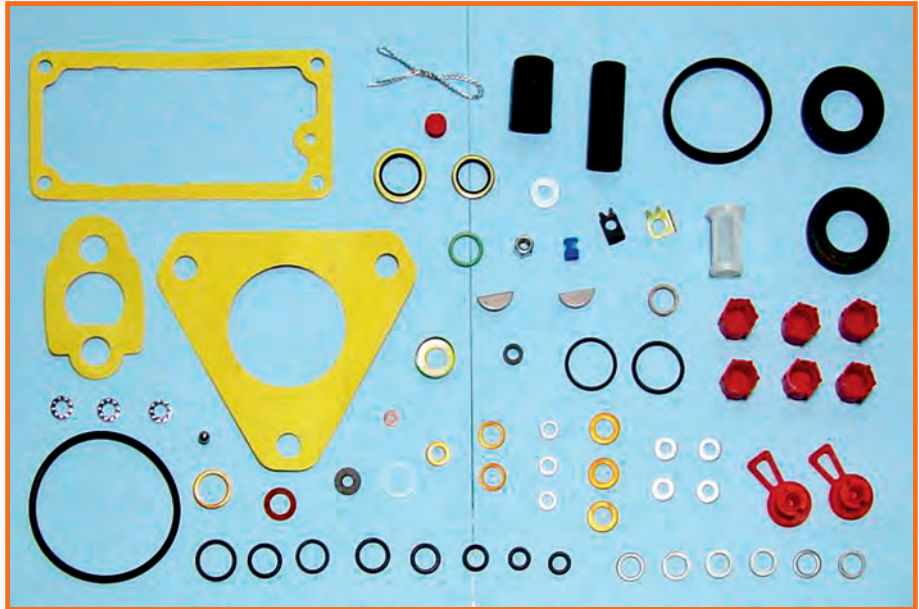

TIPO-TYPE Mapesa Mexico

CODICE OMS 11-09-096

COD. Lucas 7135-70SS

COD.

COD.

COD.

Con aggiunta 2 paraolio
22.2x35x6.35

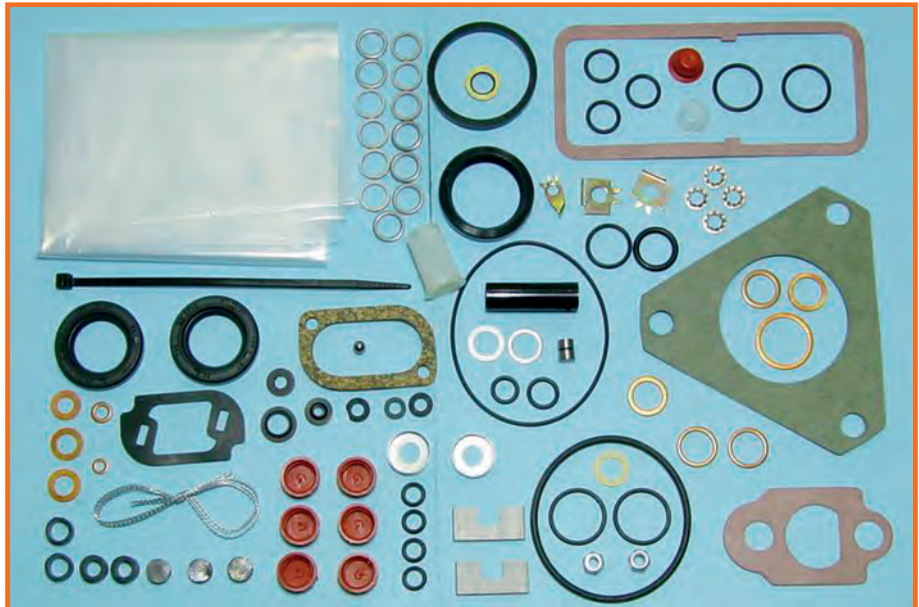

TIPO-TYPE

CODICE OMS 11-09-097

COD. Lucas 9109-240A

COD.

COD.

COD.

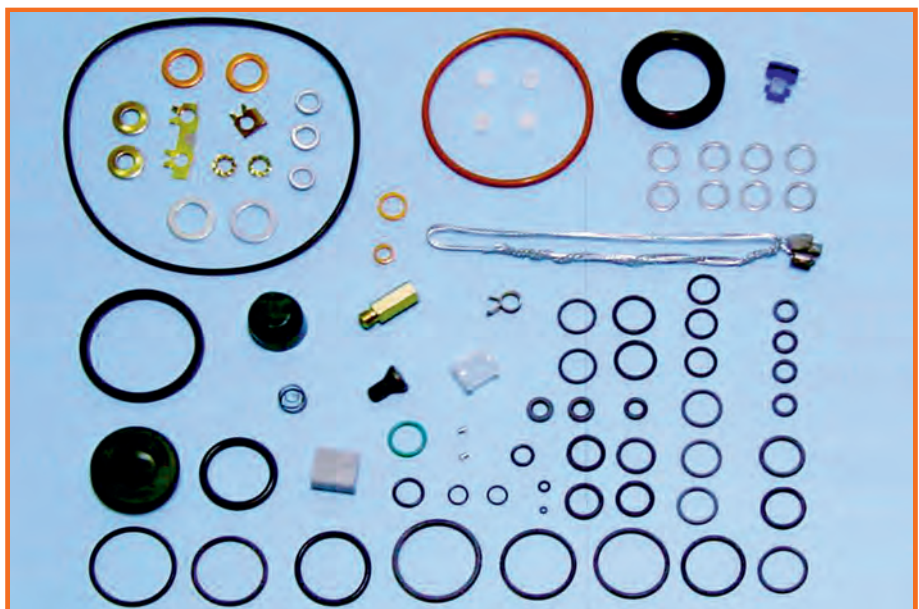

TIPO-TYPE

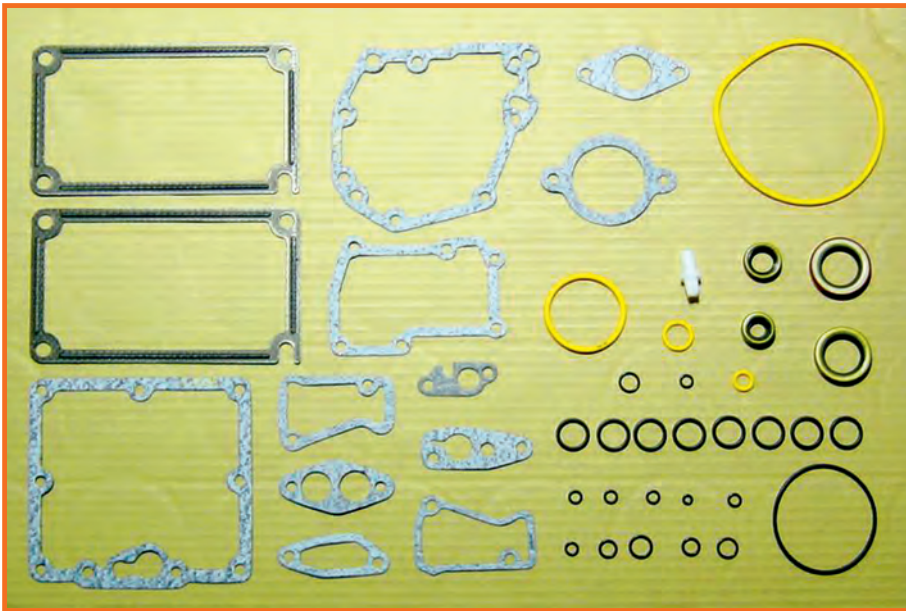

CODICE OMS 11-09-098

COD. Caterpillar 6N3723

COD.

COD.

COD.

TIPO-TYPE 8V-Cat 3208

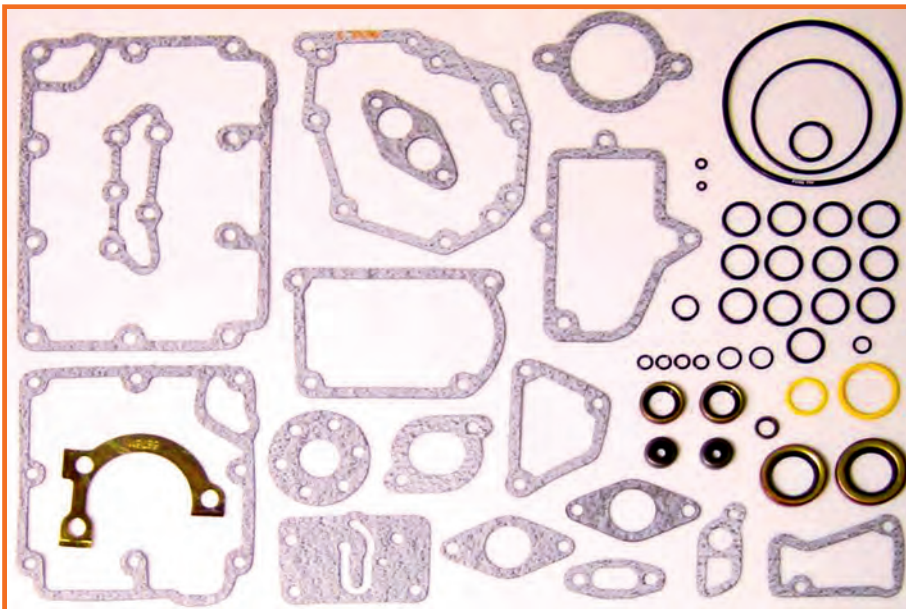

CODICE OMS 11-09-099

COD. Caterpillar 6V2901

COD.

COD.

COD.

TIPO-TYPE

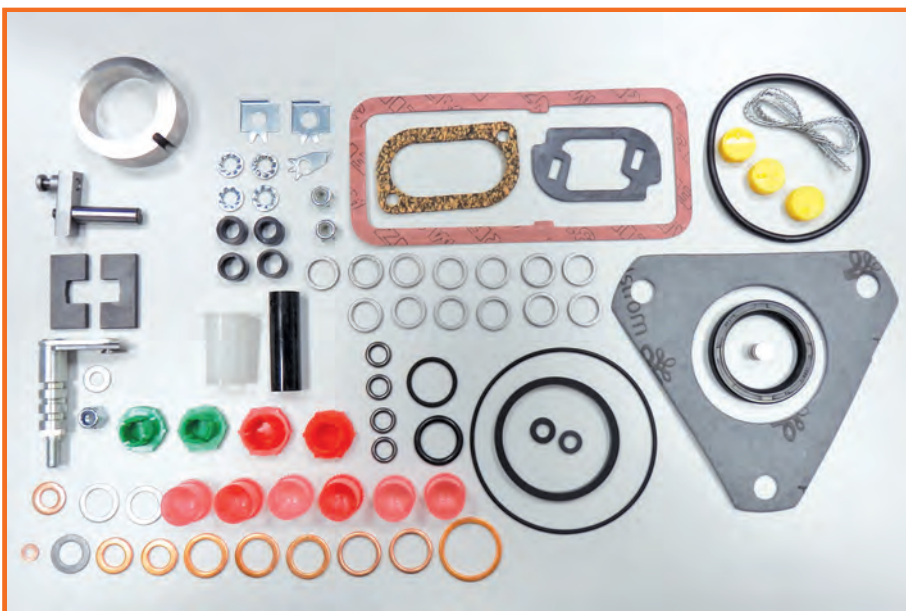

CODICE OMS 11-09-100

COD. Lucas 7135-288

COD.

COD.

COD.

TIPO-TYPE Liner kit



CODICE OMS 11-09-101

COD. Lucas 7135-289

COD.

COD.

COD.

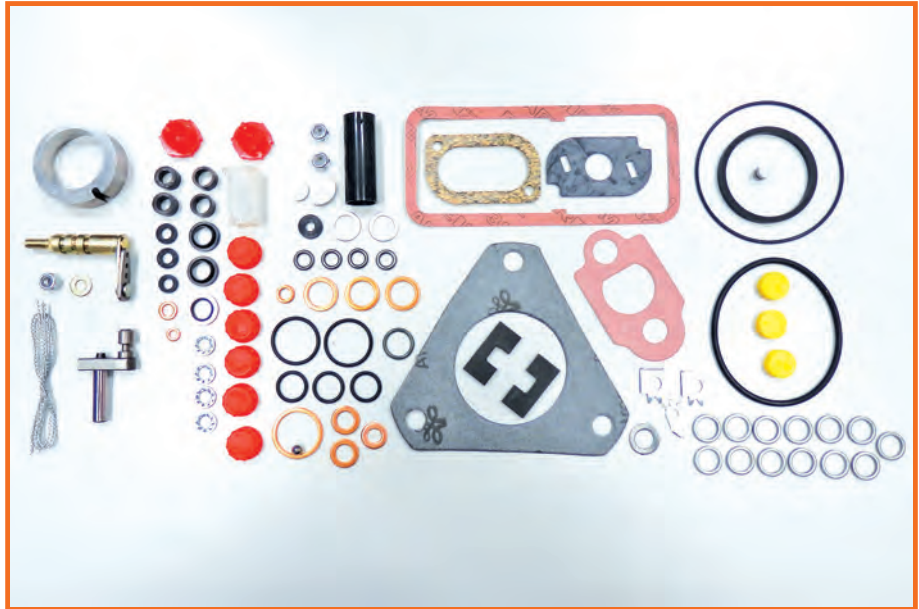

TIPO-TYPE Liner kit

CODICE OMS 11-09-102

COD. Lucas 7135-290

COD.

COD.

COD.

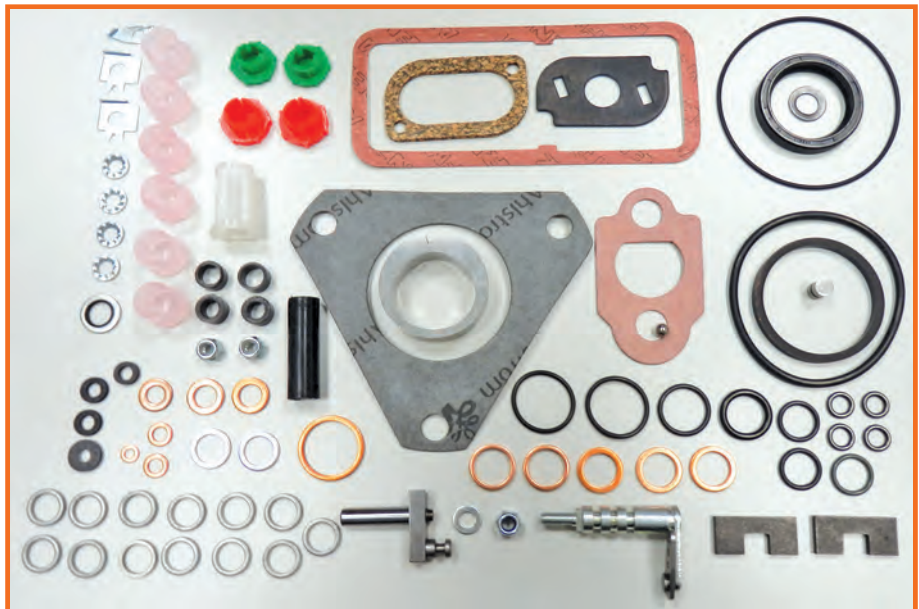

TIPO-TYPE Liner kit

CODICE OMS 11-09-103

COD. Lucas 7135-291

COD.

COD.

COD.

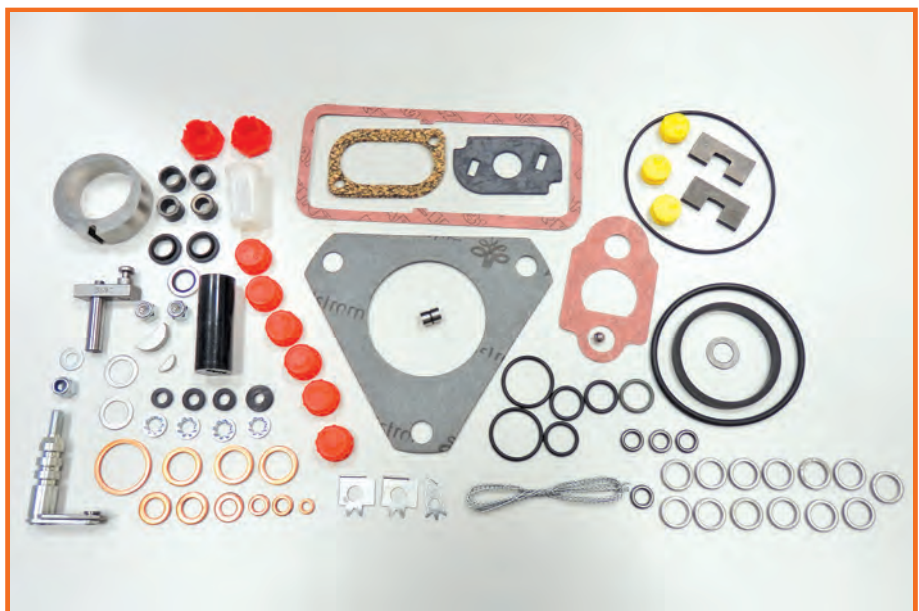

TIPO-TYPE Liner kit

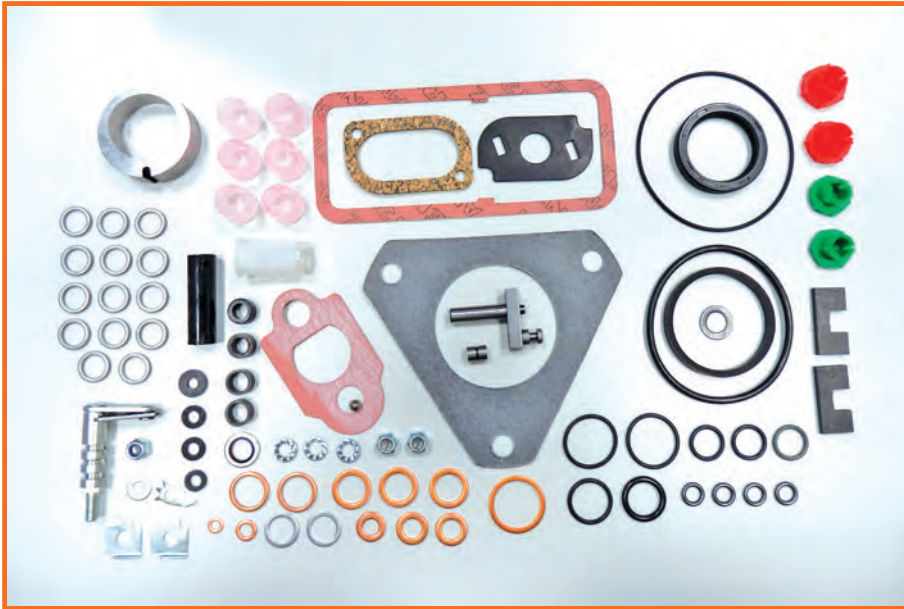

CODICE OMS 11-09-104

COD. Lucas 7135-292

COD.

COD.

COD.

TIPO-TYPE Liner kit

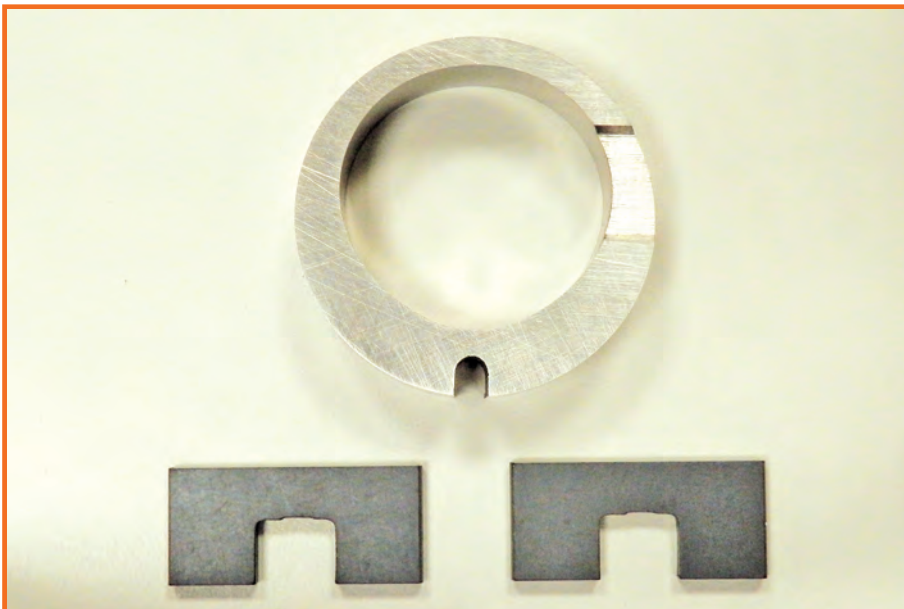

CODICE OMS 11-09-105

COD. Lucas 7135-362

COD. Anello 7139-540
Palette 7123-388

COD.

COD.

TIPO-TYPE Liner kit



CODICE OMS 11-09-106

COD. Lucas 7135-363

COD. Anello 7139-541
Palette 7123-388

COD.

COD.

TIPO-TYPE Liner kit



CODICE OMS 11-09-107

COD. Lucas 7135-364

COD. Anello 7139-223

COD. Palette 7123-388

COD.

COD.

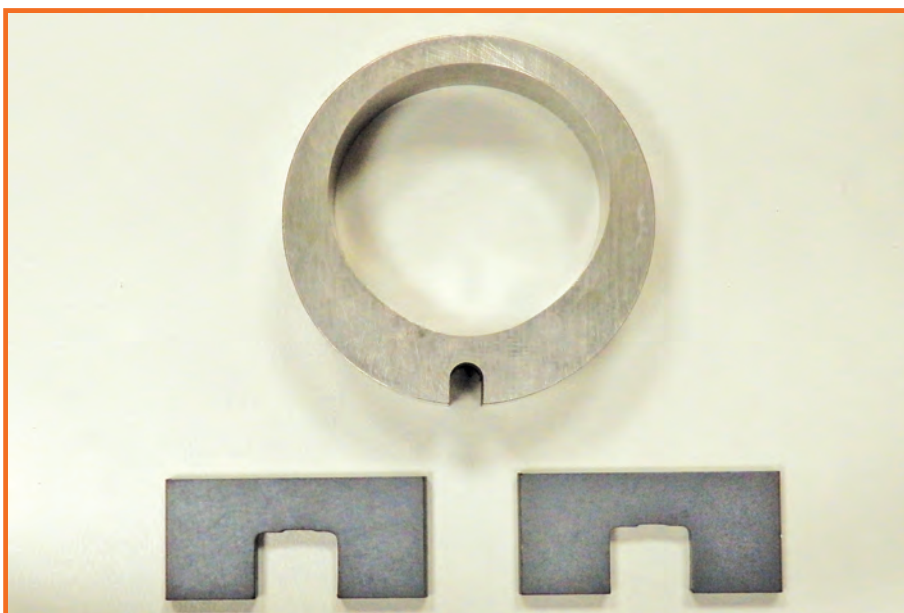

TIPO-TYPE Liner kit

CODICE OMS 11-09-108

COD. Lucas 7135-479A

COD.

COD.

COD.

11-09-108/1 pag. 154

TIPO-TYPE



CODICE OMS 11-09-109

COD. Simms 506800

COD.

COD.

COD.

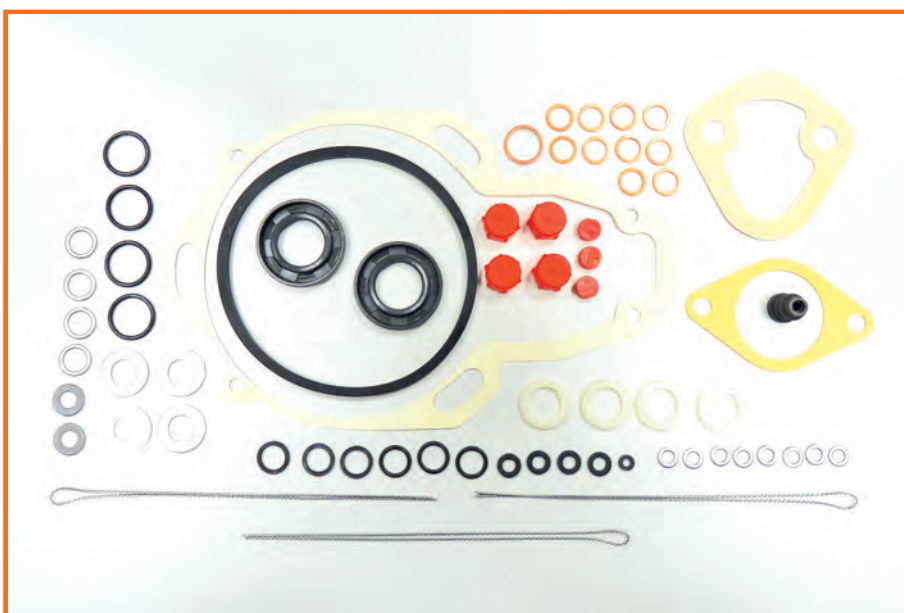

TIPO-TYPE SP GE...4A MINIMEC

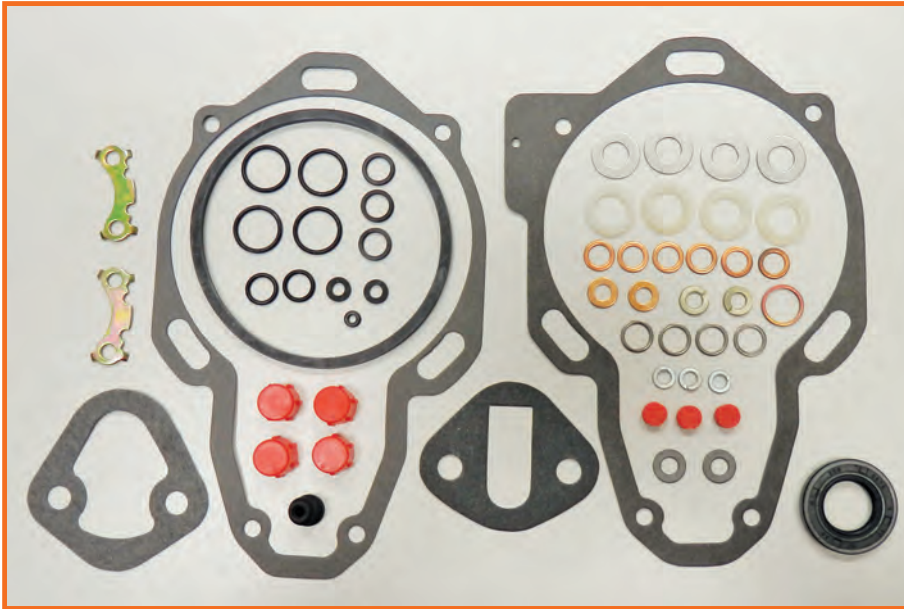

CODICE OMS 11-09-109/1

COD. Simms 506800

COD. Simms 506801

COD.

COD.

TIPO-TYPE SP GE..4A MINIMEC

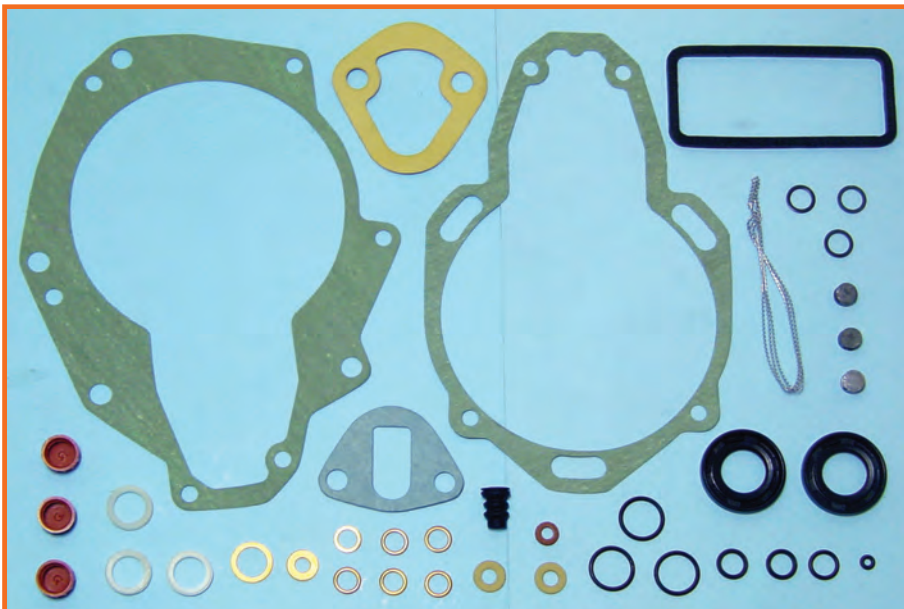

CODICE OMS 11-09-110

COD. Simms 506804

COD.

COD.

COD.

TIPO-TYPE SP GE...3

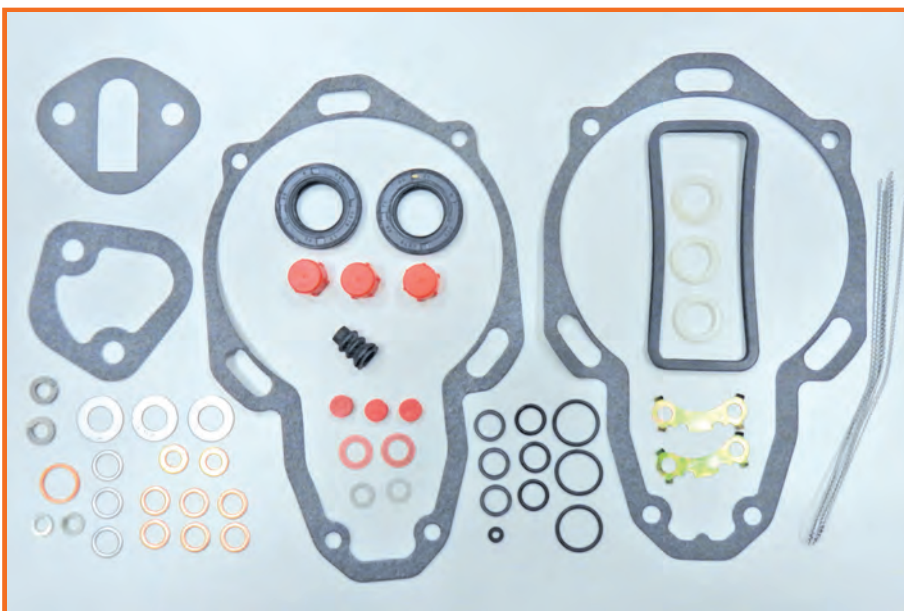

CODICE OMS 11-09-110/1

COD. Simms 506804

COD. Simms 506805

COD.

COD.

TIPO-TYPE SP GE...3

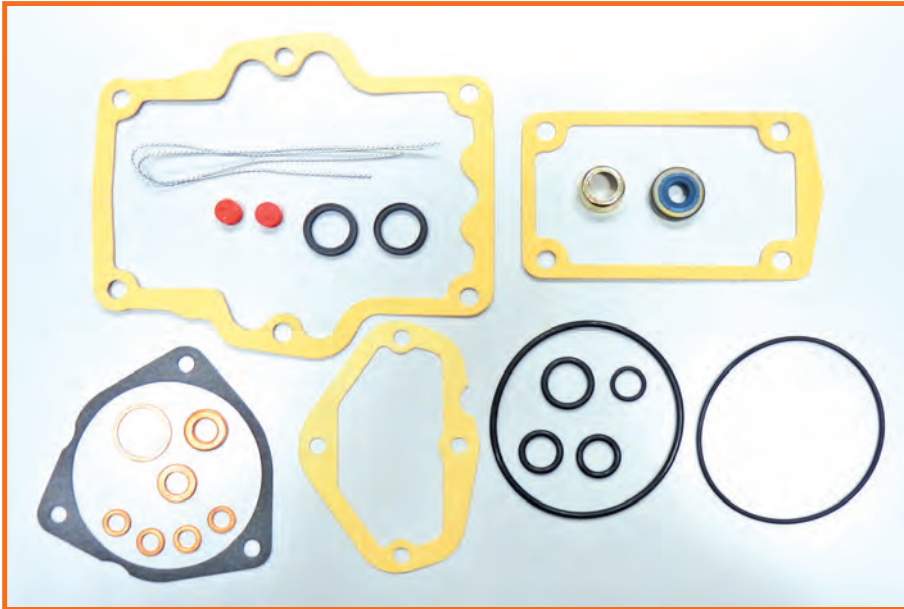

CODICE OMS 11-09-113

COD. Ambac KT 85195

COD. _____

COD. _____

COD. _____

TIPO-TYPE

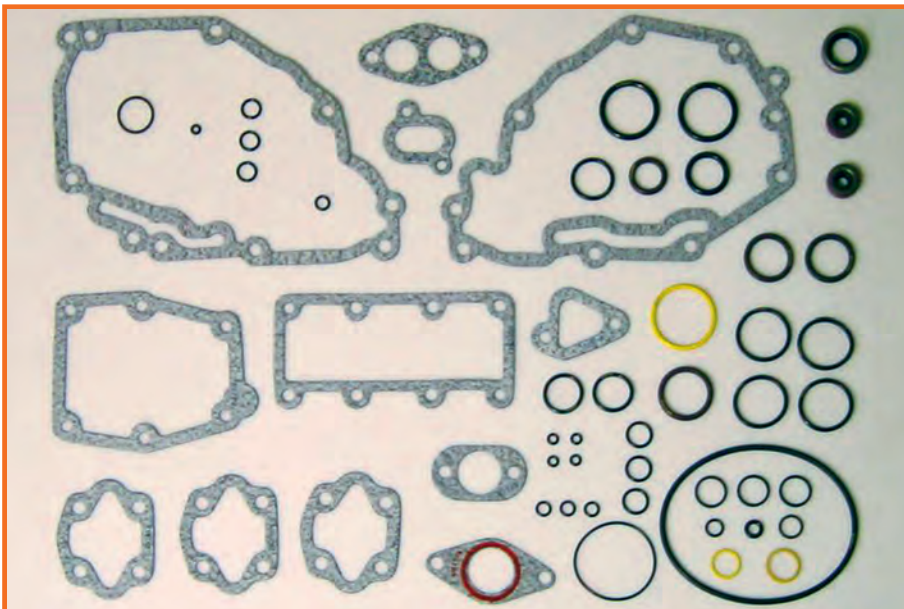

CODICE OMS 11-09-114

COD. Caterpillar 8T6734

COD. _____

COD. _____

COD. _____

TIPO-TYPE

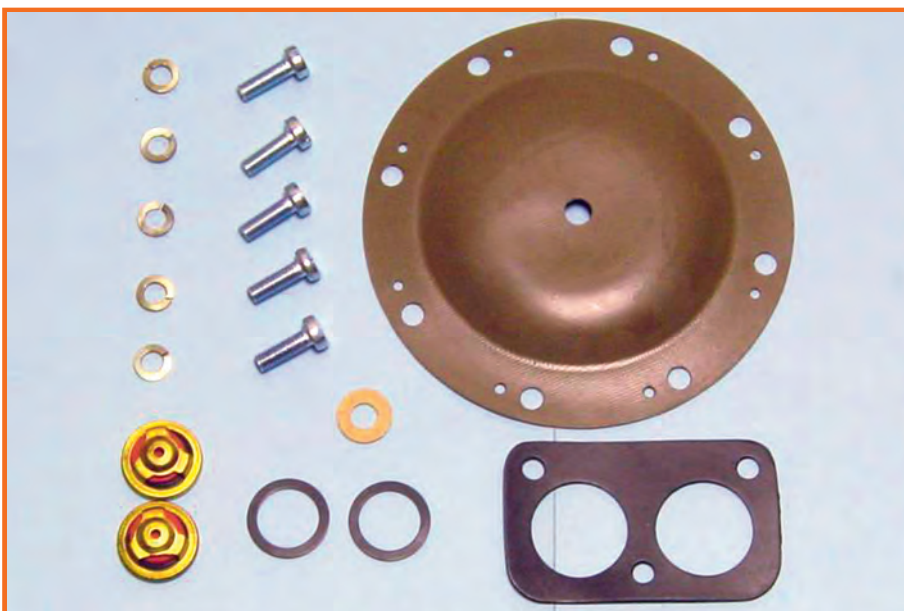

CODICE OMS 11-09-115

COD. BCD 7321 7320/2

COD. _____

COD. _____

COD. _____

TIPO-TYPE Vacuum pumps



CODICE OMS 11-09-116

COD. Lucas 7135-84

COD.

COD.

COD.

TIPO-TYPE DPA

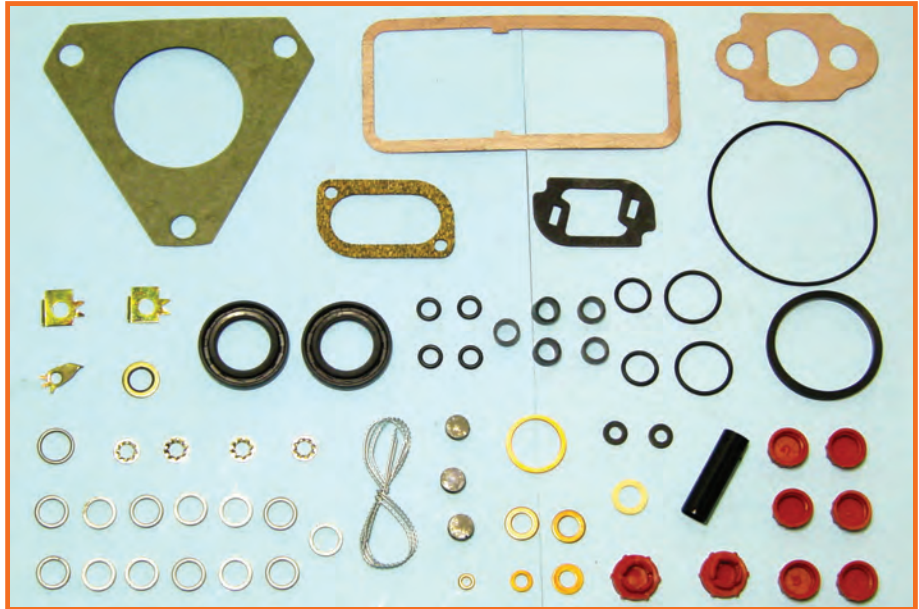

CODICE OMS 11-09-119

COD. Caterpillar 6V2245

COD.

COD.

COD.

TIPO-TYPE

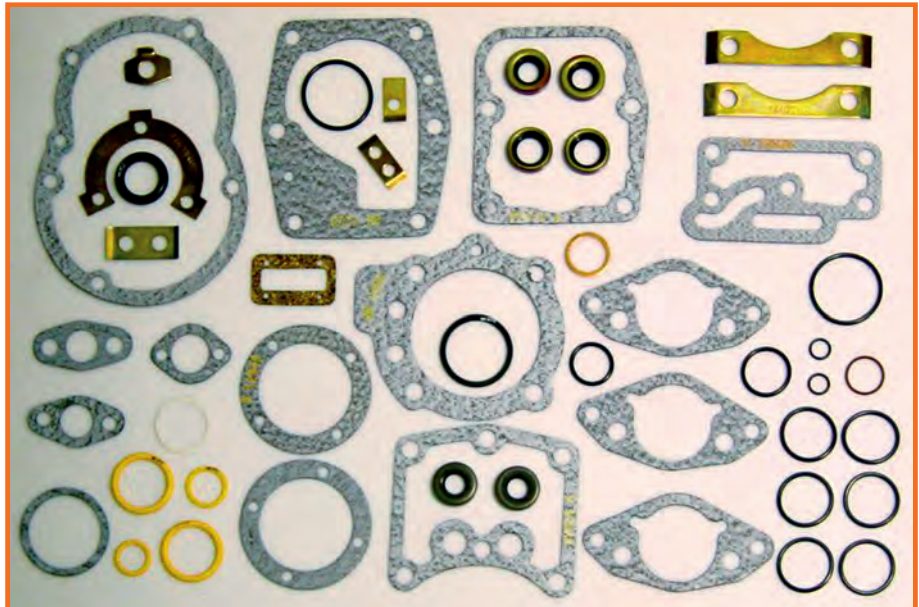

CODICE OMS 11-09-120

COD. Caterpillar 5P9556

COD.

COD.

COD.

TIPO-TYPE

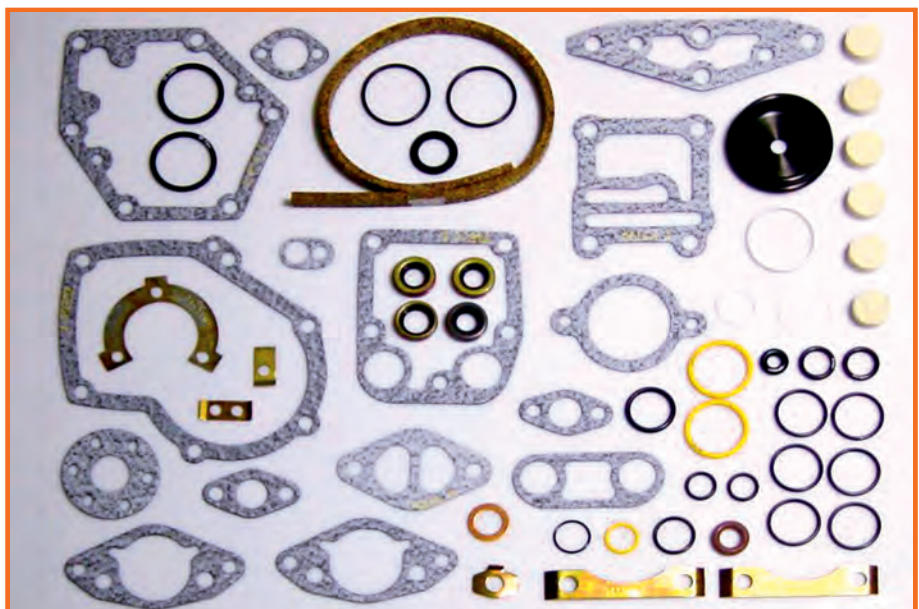

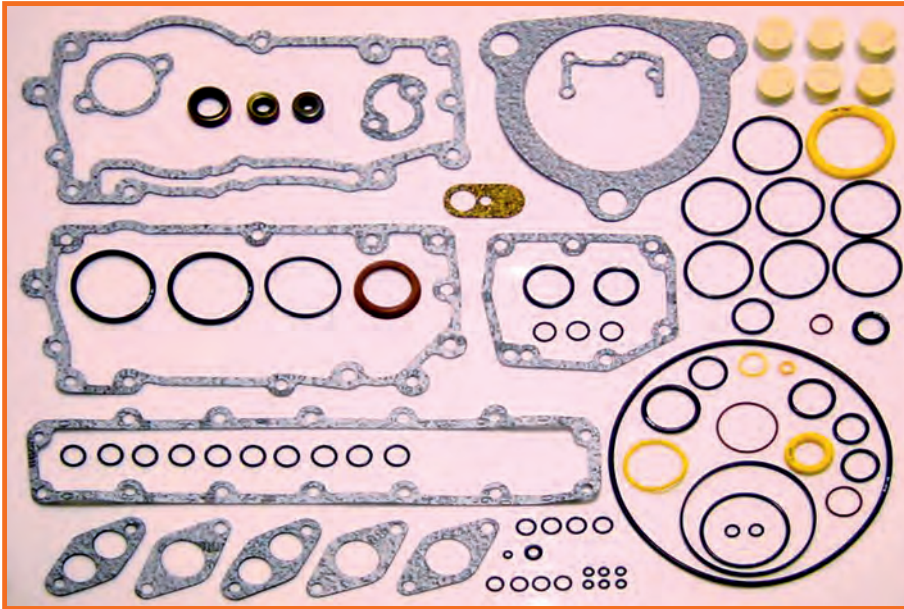

CODICE OMS 11-09-121

COD. Caterpillar 8T9081

COD.

COD.

COD.

TIPO-TYPE

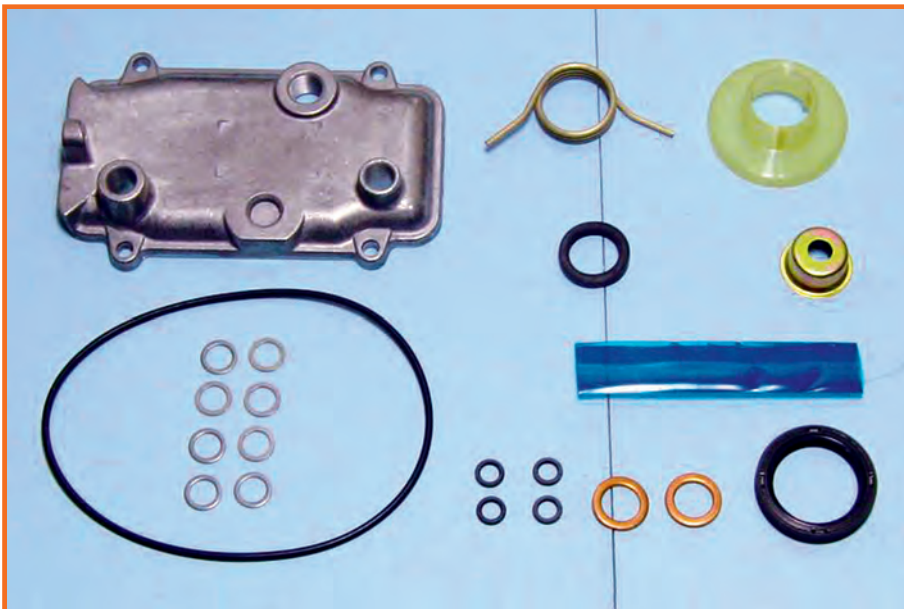

CODICE OMS 11-09-122

COD. Lucas 9109-620

COD.

COD.

COD.

TIPO-TYPE Coperchio DPC

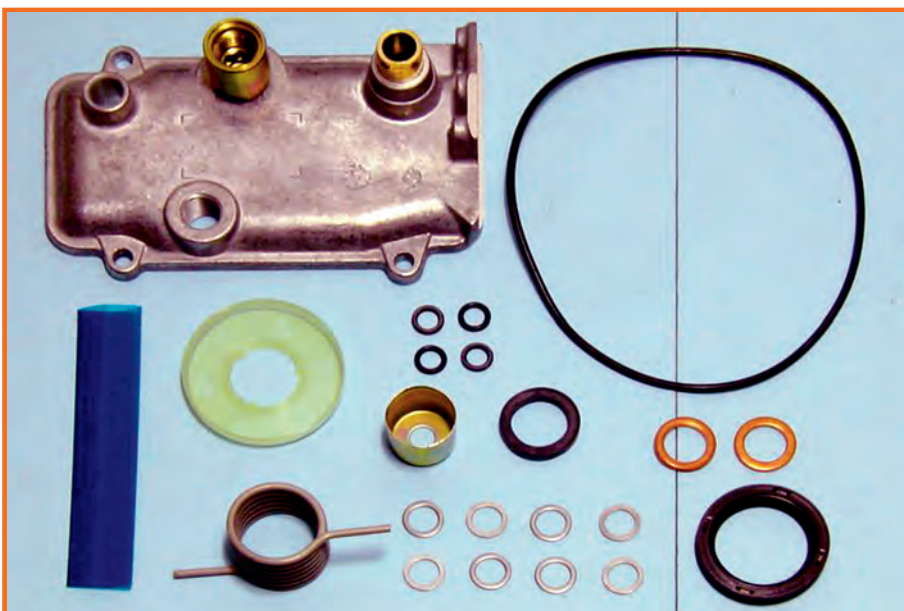

CODICE OMS 11-09-123

COD. Lucas 9109-620D

COD.

COD.

COD.

TIPO-TYPE Coperchio DPC



CODICE OMS 11-09-124

COD. Lucas 9109-620G

COD.

COD.

COD.

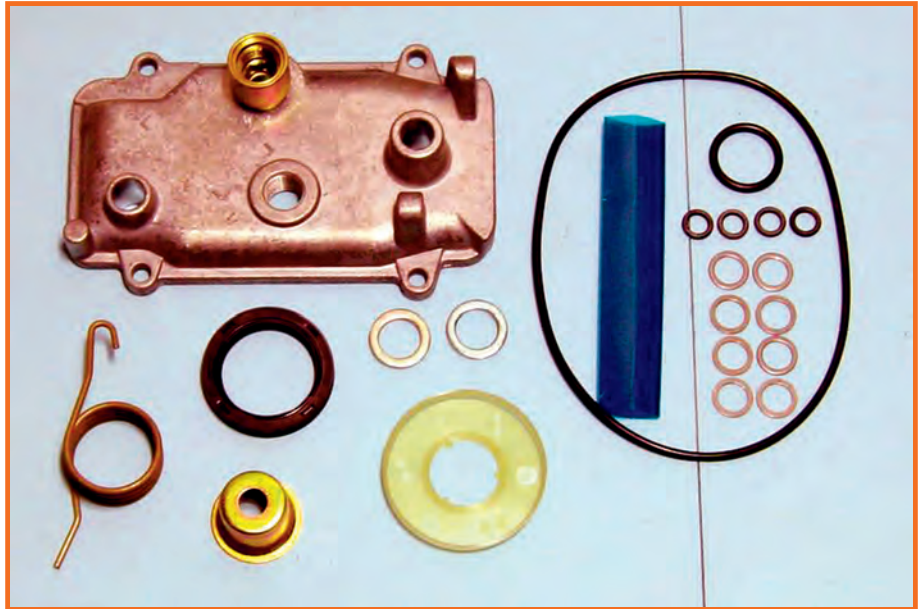

TIPO-TYPE Coperchio DPC

CODICE OMS 11-09-125

COD. Lucas 9109-620H

COD.

COD.

COD.

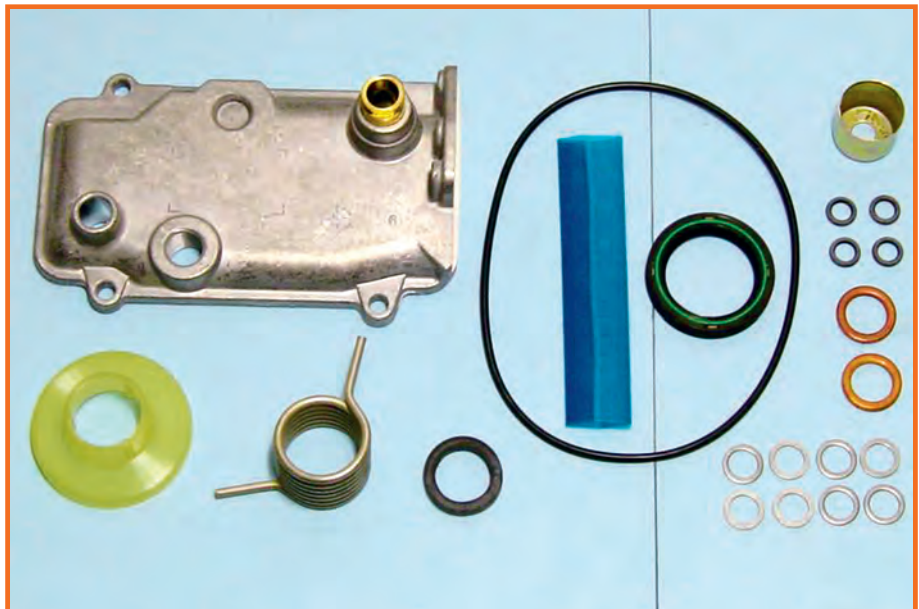

TIPO-TYPE Coperchio DPC

CODICE OMS 11-09-126

COD. Lucas 9109-620J

COD.

COD.

COD.

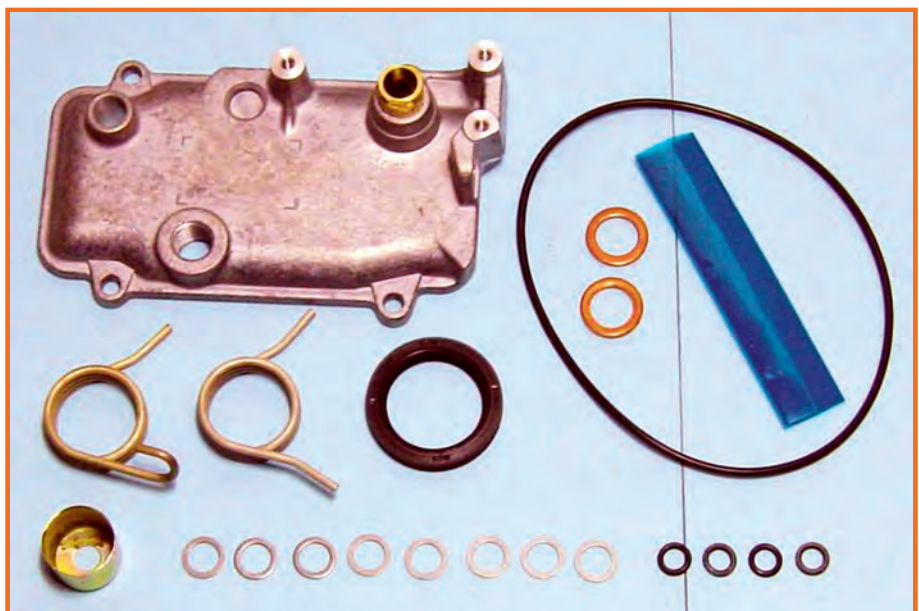

TIPO-TYPE Coperchio DPC

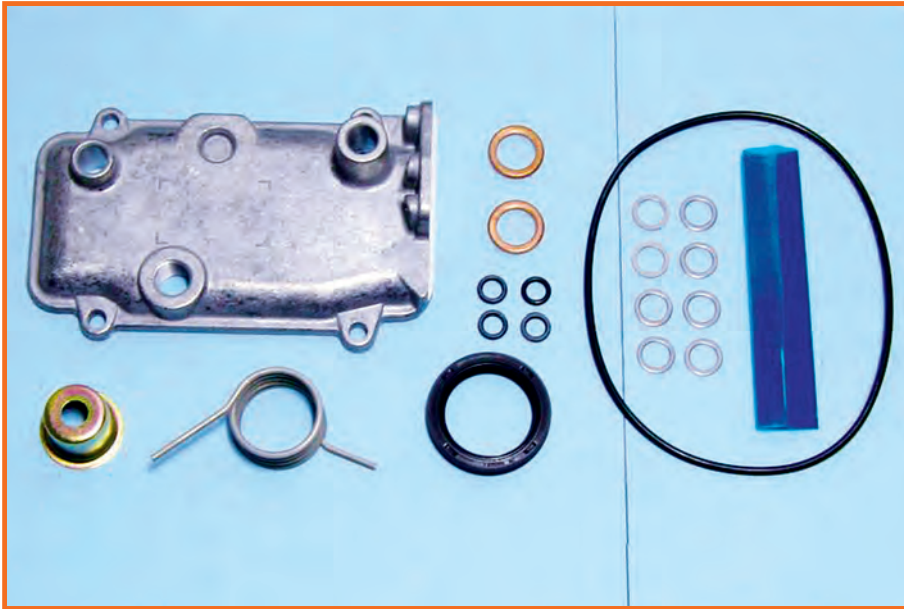

CODICE OMS 11-09-127

COD. Lucas 9109-620K

COD.

COD.

COD.

TIPO-TYPE Coperchio DPC

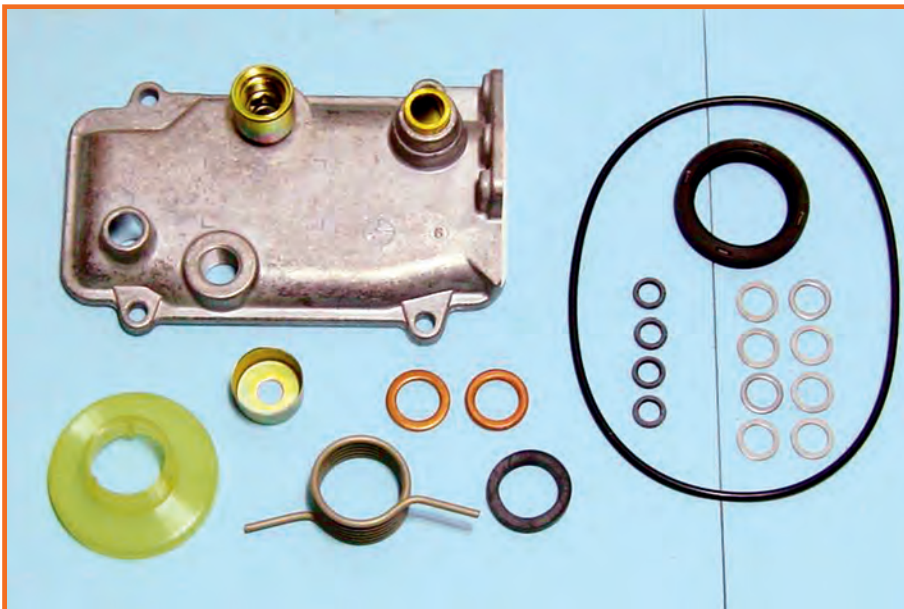

CODICE OMS 11-09-128

COD. Lucas 9109-620L

COD.

COD.

COD.

TIPO-TYPE Coperchio DPC

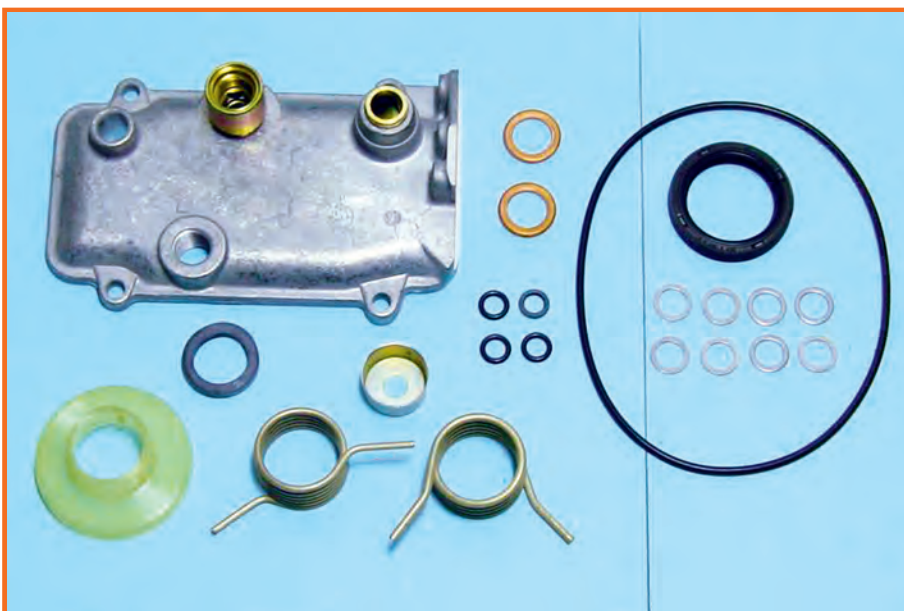

CODICE OMS 11-09-129

COD. Lucas 9109-620M

COD.

COD.

COD.

TIPO-TYPE Coperchio DPC



CODICE OMS 11-09-130

COD. Lucas 9109-620N

COD.

COD.

COD.

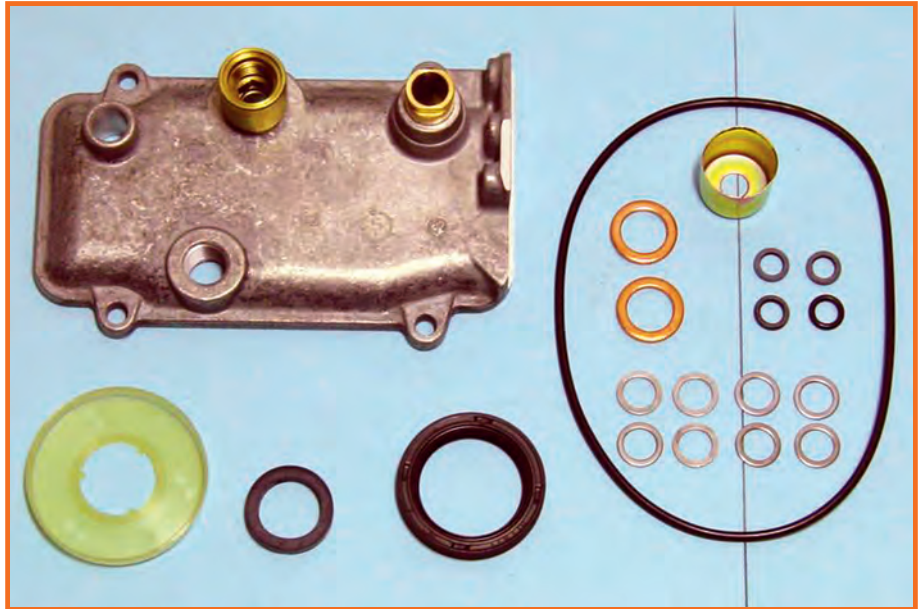

TIPO-TYPE Coperchio DPC

CODICE OMS 11-09-131

COD. Lucas 9109-620P

COD.

COD.

COD.

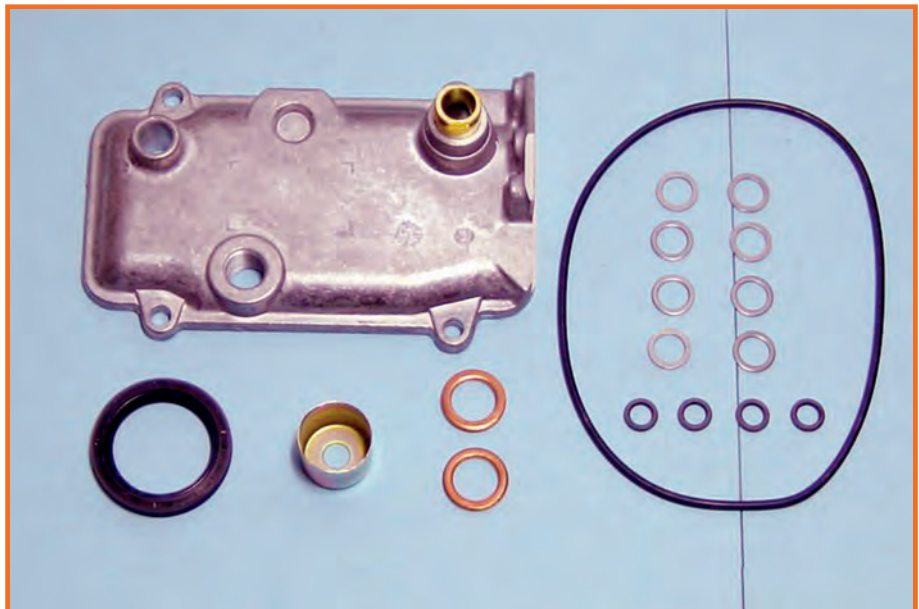

TIPO-TYPE Coperchio DPC

CODICE OMS 11-09-132

COD. Caterpillar 6V1683

COD.

COD.

COD.

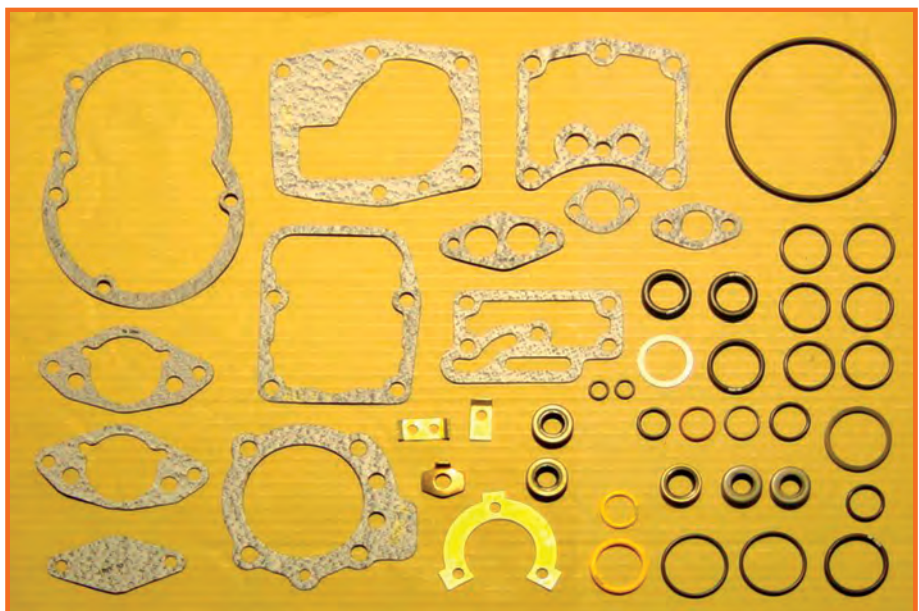

TIPO-TYPE

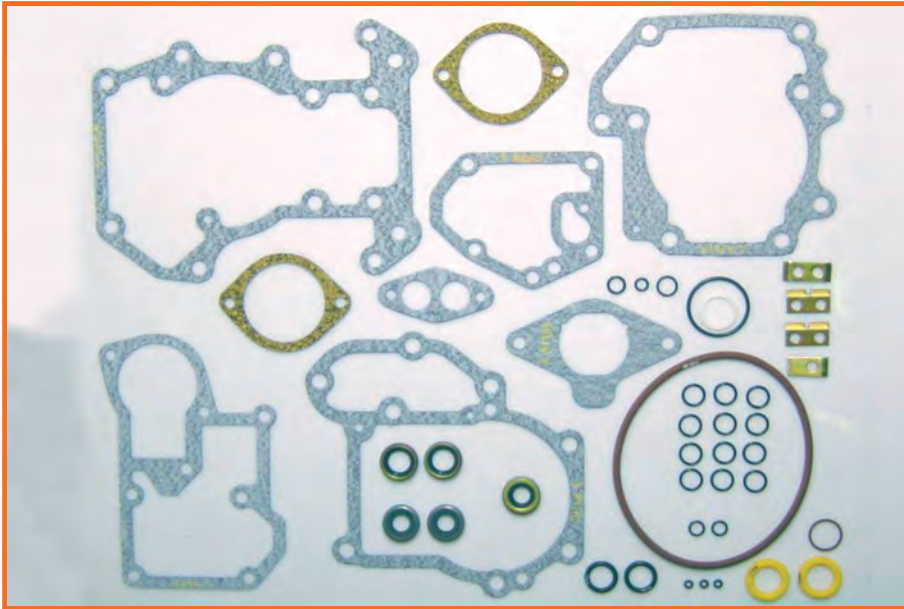

CODICE OMS 11-09-133

COD. Caterpillar 6V5411

COD.

COD.

COD.

TIPO-TYPE

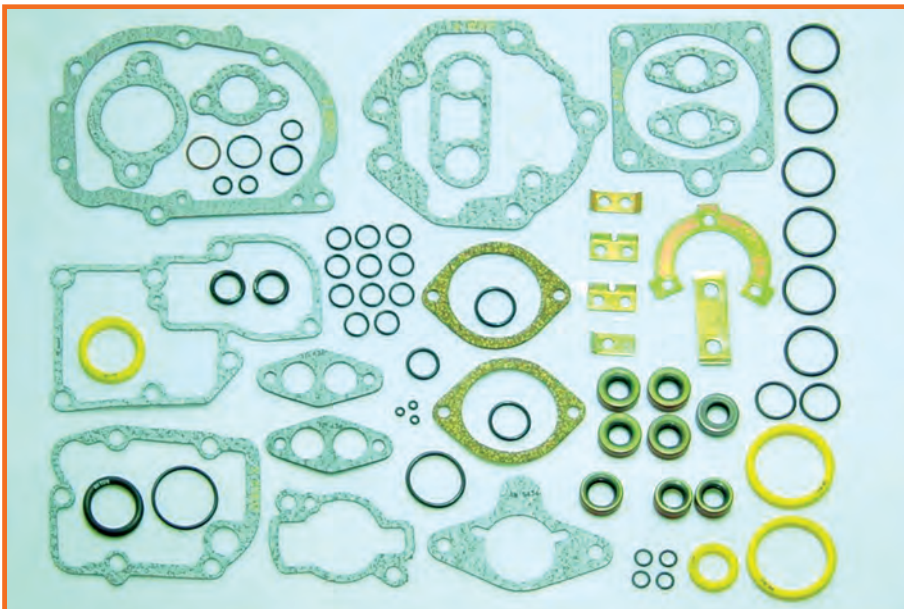

CODICE OMS 11-09-134

COD. Caterpillar 5P8214

COD.

COD.

COD.

TIPO-TYPE

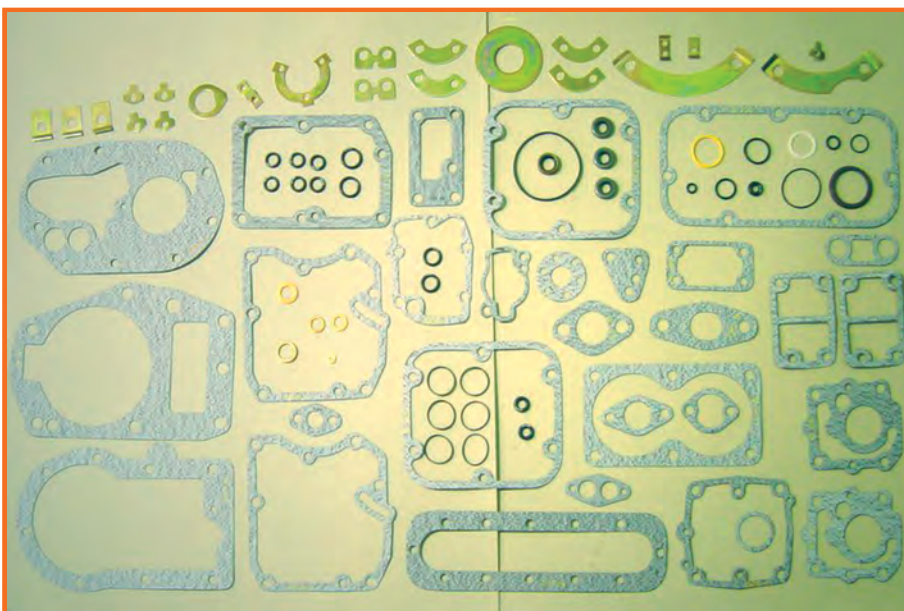

CODICE OMS 11-09-135

COD. Caterpillar 5P8961

COD.

COD.

COD.

TIPO-TYPE



CODICE OMS 11-09-136

COD. Caterpillar 6V1148

COD.

COD.

COD.

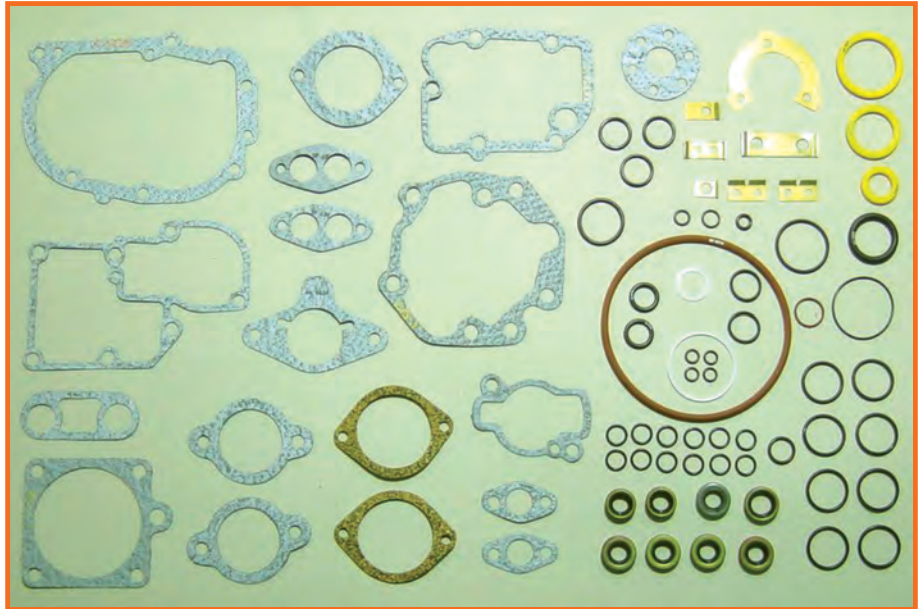

TIPO-TYPE

CODICE OMS 11-09-137

COD. Caterpillar 6V1503

COD.

COD.

COD.

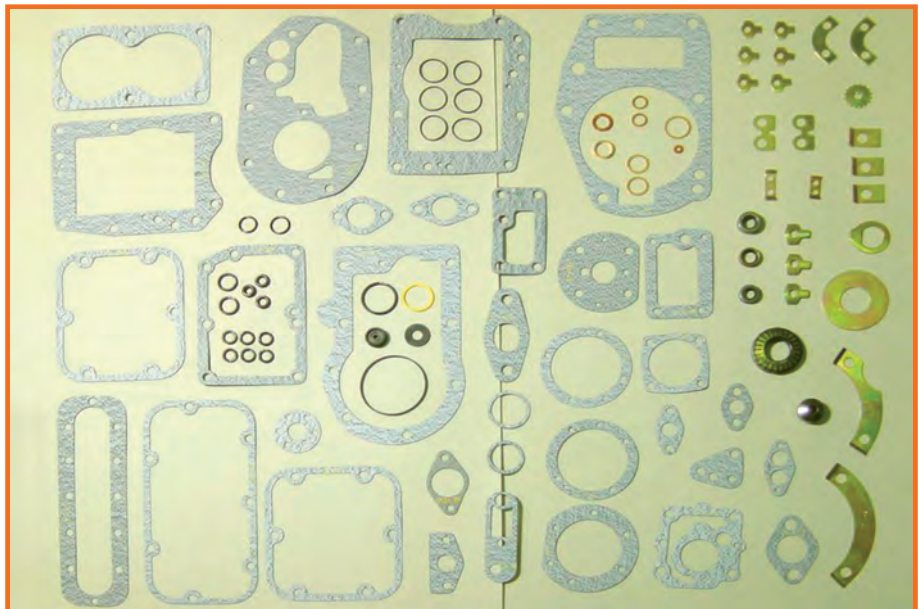

TIPO-TYPE

CODICE OMS 11-09-140

COD. Caterpillar 6V8042

COD.

COD.

COD.

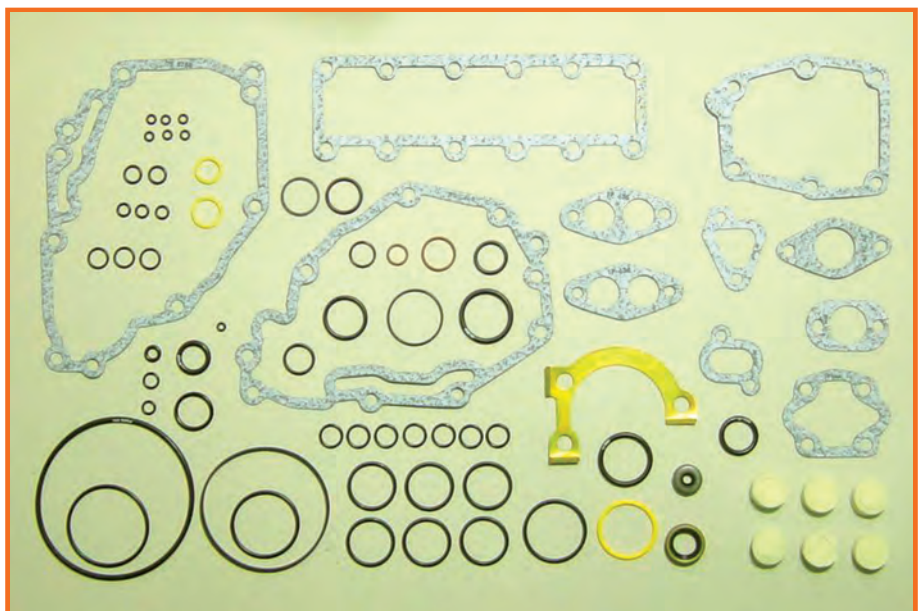

TIPO-TYPE

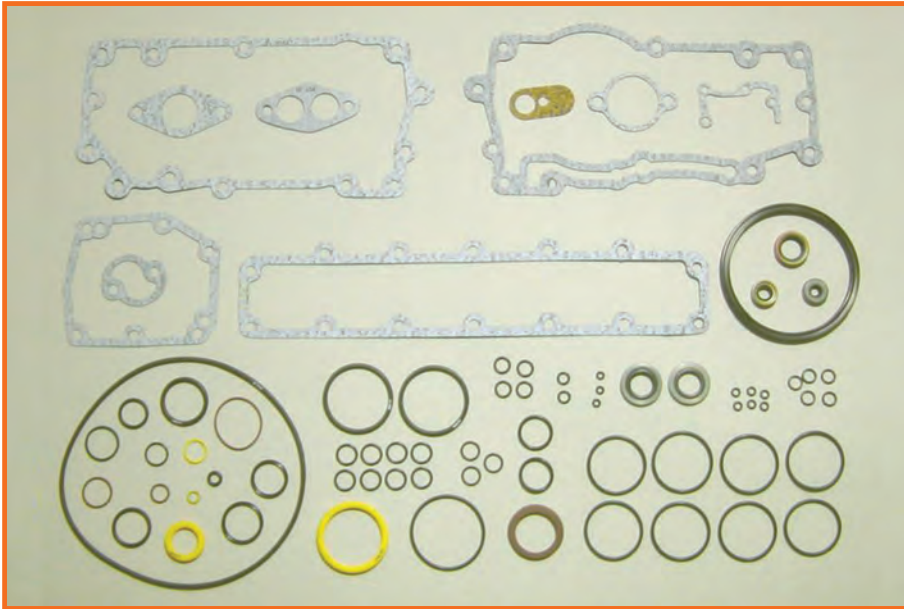

CODICE OMS 11-09-141

COD. Caterpillar 6V9894

COD. _____

COD. _____

COD. _____

TIPO-TYPE

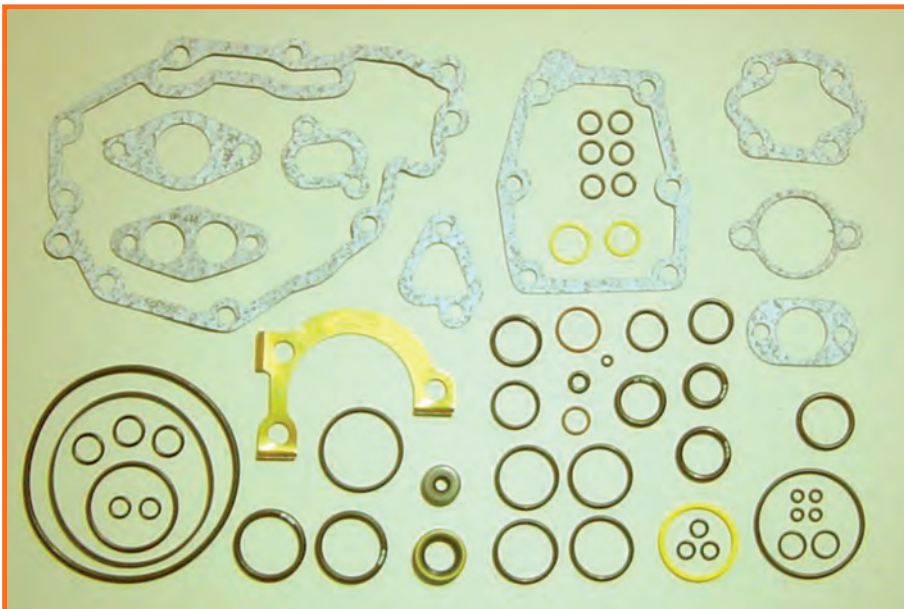

CODICE OMS 11-09-142

COD. Caterpillar 8T4856

COD. _____

COD. _____

COD. _____

TIPO-TYPE

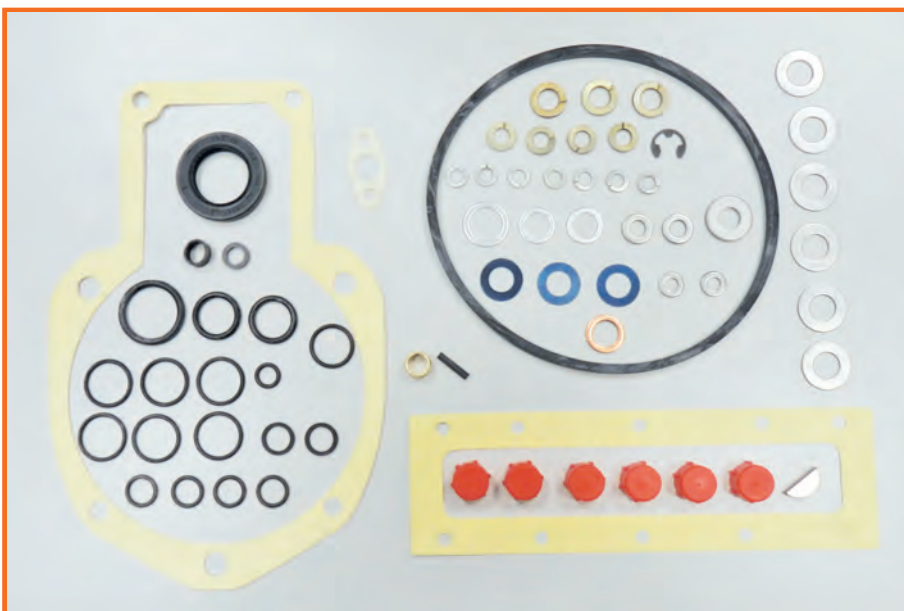

CODICE OMS 11-09-143

COD. SP..GCE

COD. _____

COD. _____

COD. _____

Simms 6 cilindri Ford-Perkins

TIPO-TYPE



CODICE OMS 11-09-144

COD. Lucas 9059-8A

COD.

COD.

COD.

Kit coperchio DPA per Brasile

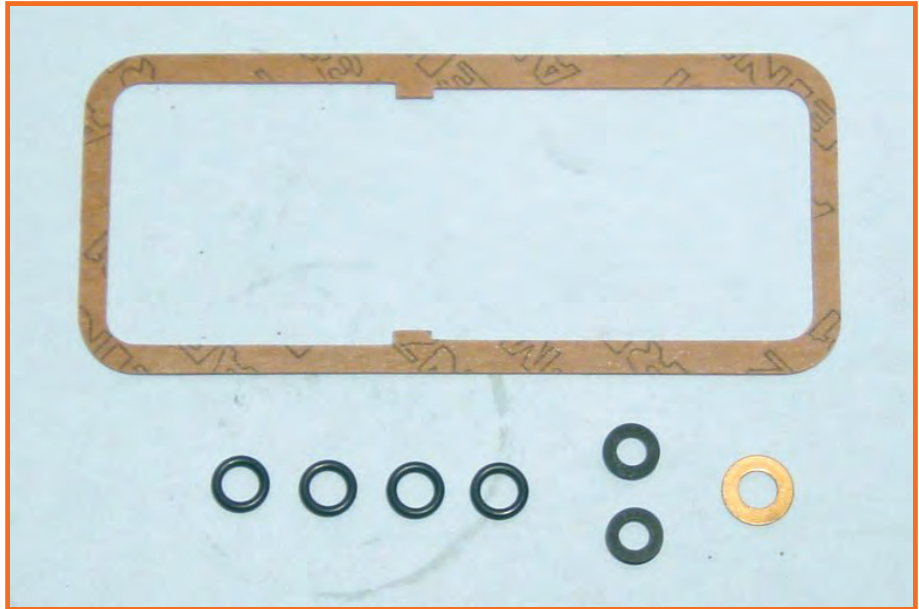

TIPO-TYPE

CODICE OMS 11-09-145

COD. Lucas 7135-70R

COD.

COD.

COD.

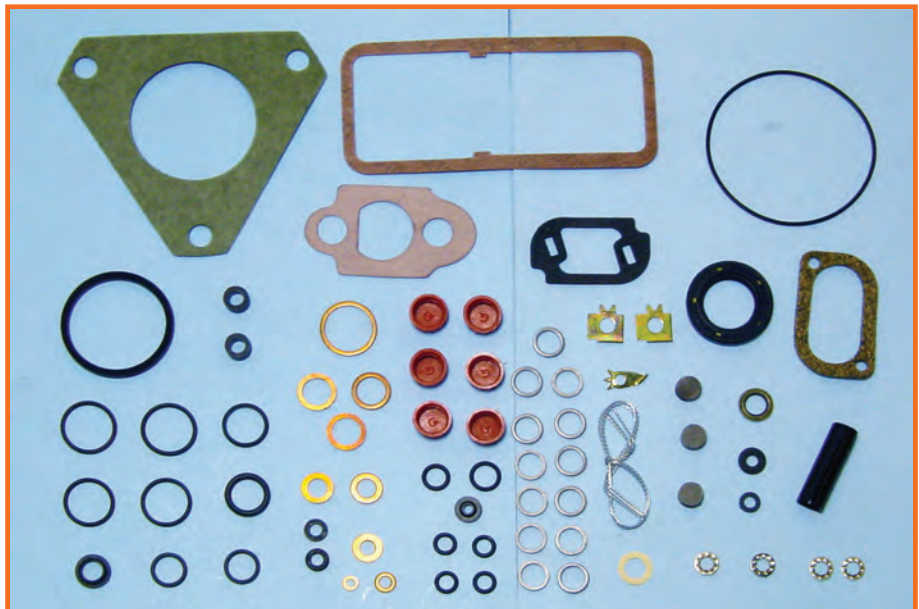

TIPO-TYPE DPA

CODICE OMS 11-09-146

COD. Caterpillar 6V4760

COD.

COD.

COD.

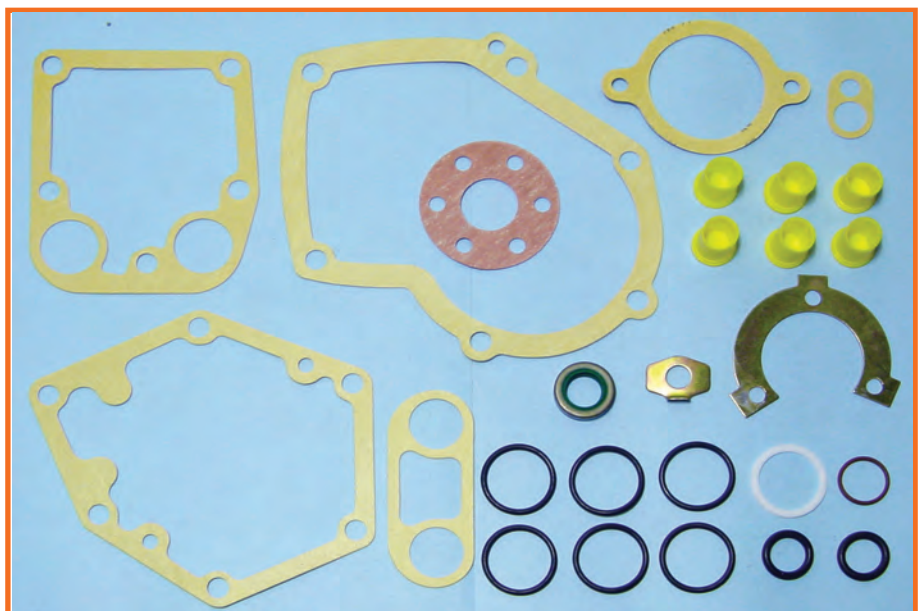

TIPO-TYPE

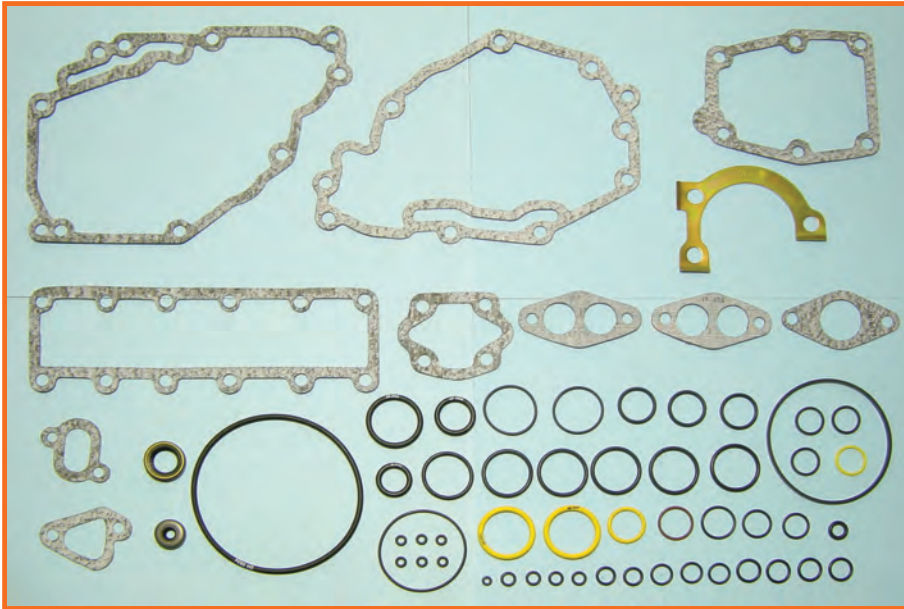

CODICE OMS 11-09-147

COD. Caterpillar 6V2914

COD.

COD.

COD.

TIPO-TYPE

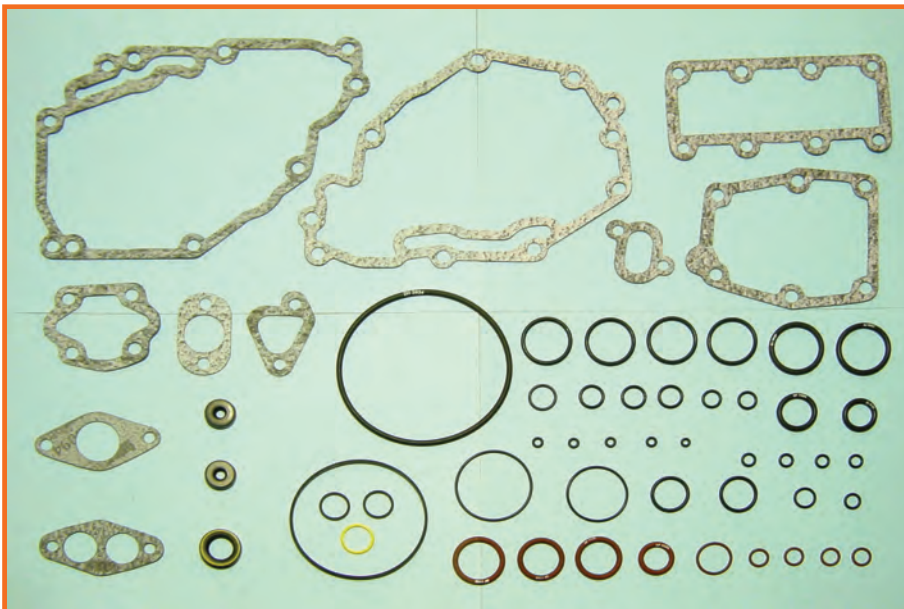

CODICE OMS 11-09-148

COD. Caterpillar 6V9882

COD.

COD.

COD.

TIPO-TYPE



CODICE OMS 11-09-149

COD. Lucas 7135-277J

COD.

COD.

COD.

TIPO-TYPE



CODICE OMS 11-09-150

COD. Caterpillar 8T9484

COD.

COD.

COD.

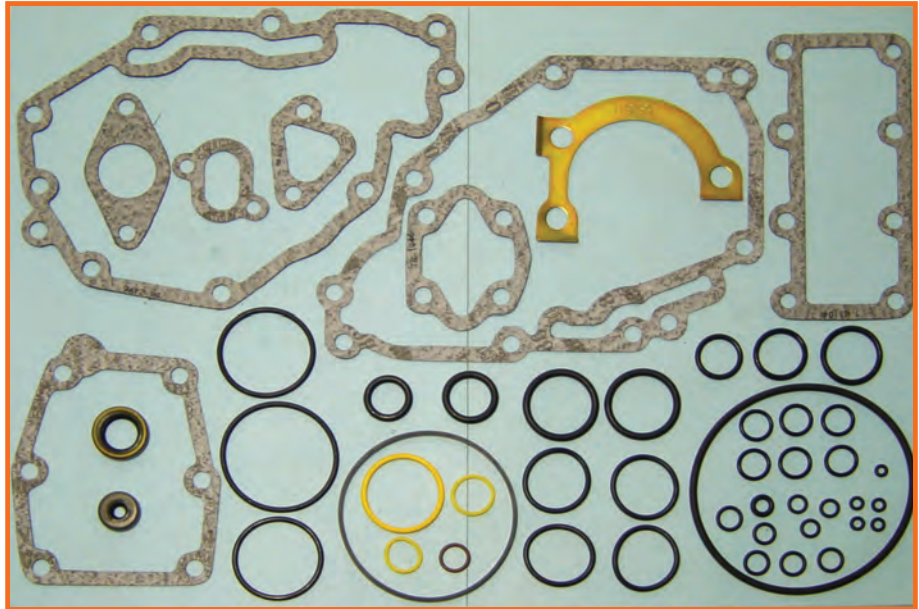

TIPO-TYPE

CODICE OMS 11-09-151

COD. Lucas 7135-277H

COD.

COD.

COD.



TIPO-TYPE

CODICE OMS 11-09-152

COD. Lucas 9109-240

COD.

COD.

COD.

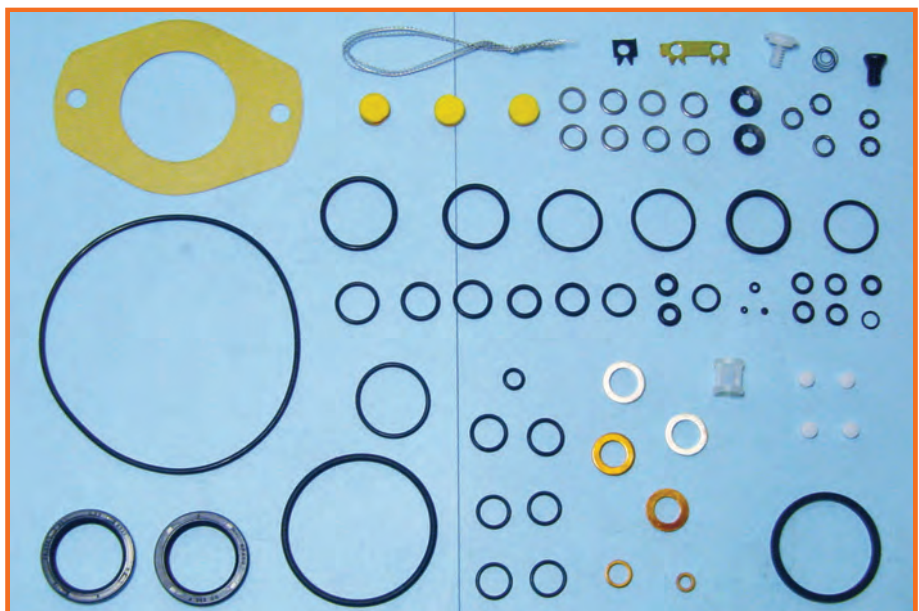

TIPO-TYPE DPC

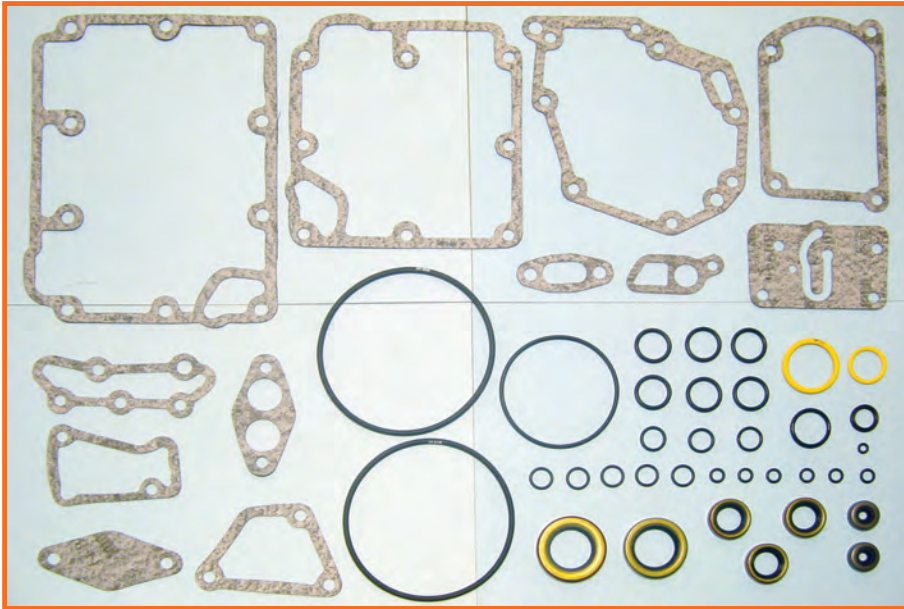

CODICE OMS 11-09-153

COD. Caterpillar 5P9461

COD.

COD.

COD.

TIPO-TYPE

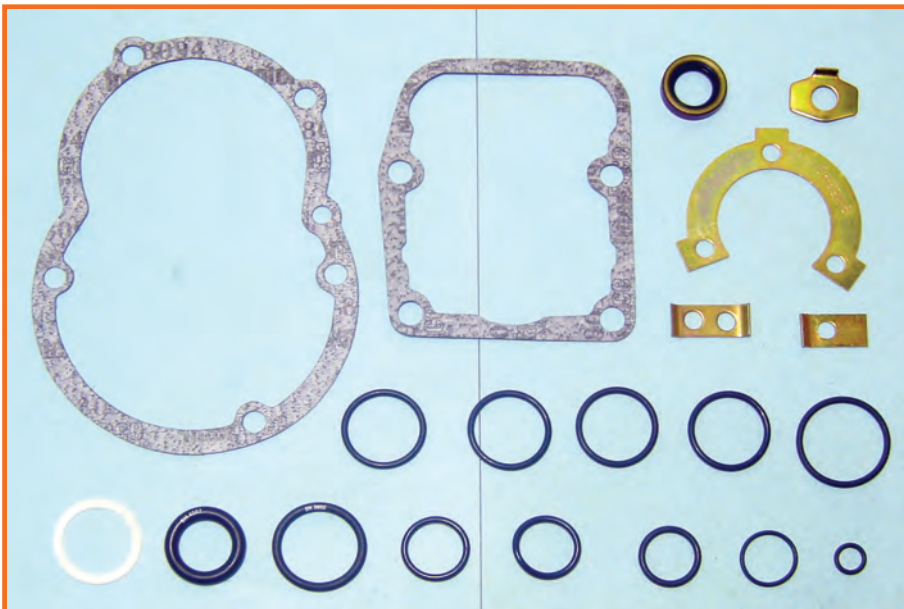

CODICE OMS 11-09-154

COD. Caterpillar 5P9948

COD.

COD.

COD.

TIPO-TYPE

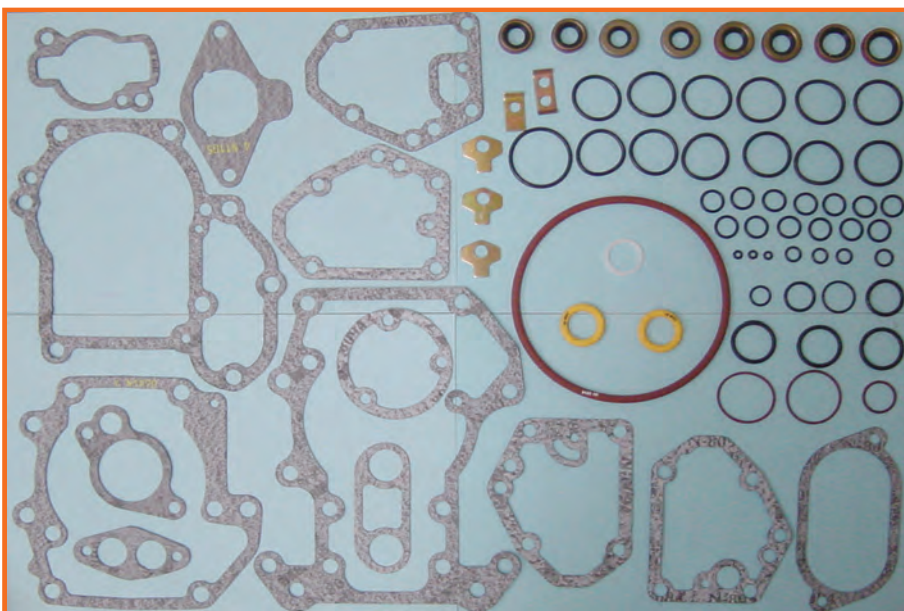

CODICE OMS 11-09-155

COD. Caterpillar 6V1167

COD.

COD.

COD.

TIPO-TYPE



CODICE OMS 11-09-156

COD. Caterpillar 8T2500

COD.

COD.

COD.

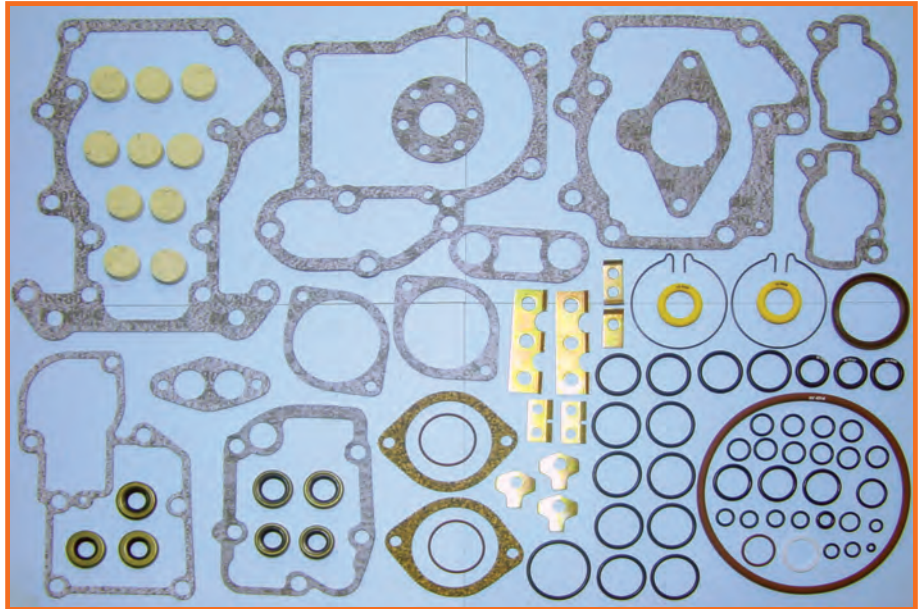

TIPO-TYPE

CODICE OMS 11-09-157

COD. Caterpillar 5P9229

COD.

COD.

COD.

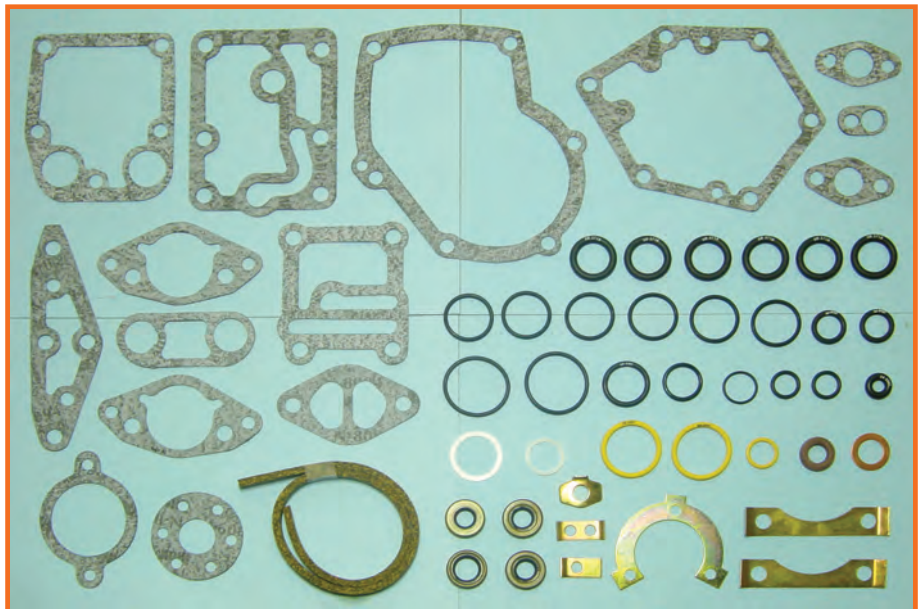

TIPO-TYPE

CODICE OMS 11-09-158

COD. Caterpillar 6V1848

COD.

COD.

COD.

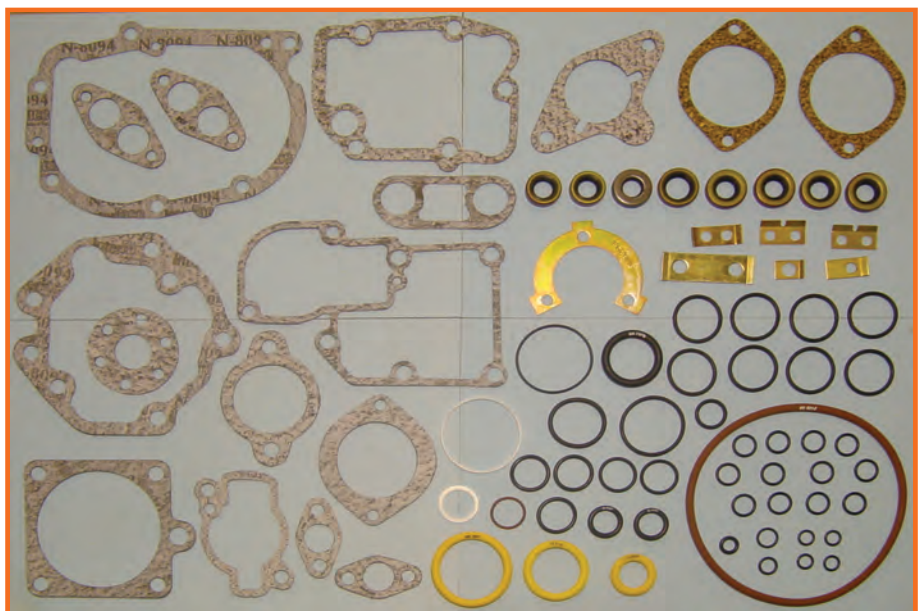

TIPO-TYPE

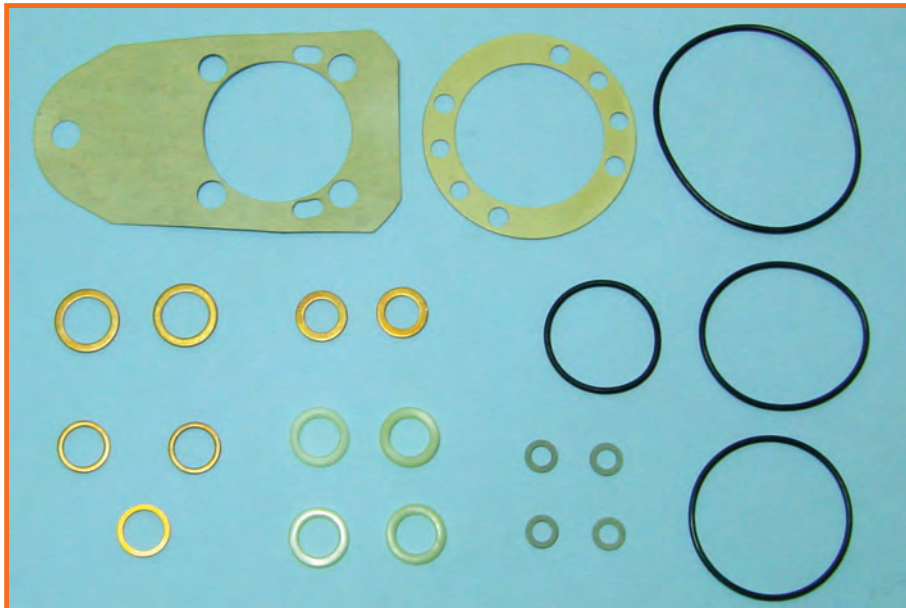

CODICE OMS 11-09-159

COD. Lucas 7135-228

COD.

COD.

COD.

TIPO-TYPE

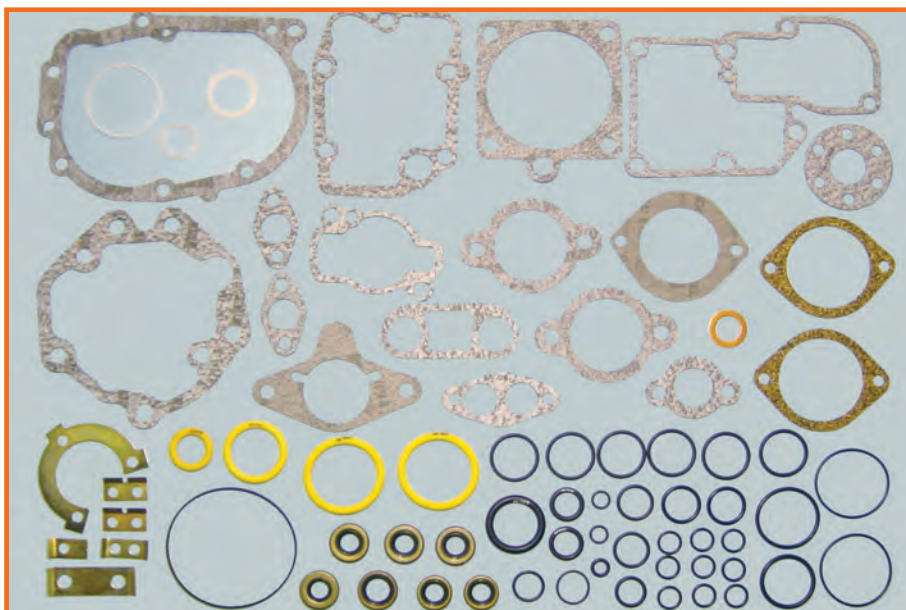

CODICE OMS 11-09-160

COD. Caterpillar 5P8329

COD.

COD.

COD.

TIPO-TYPE

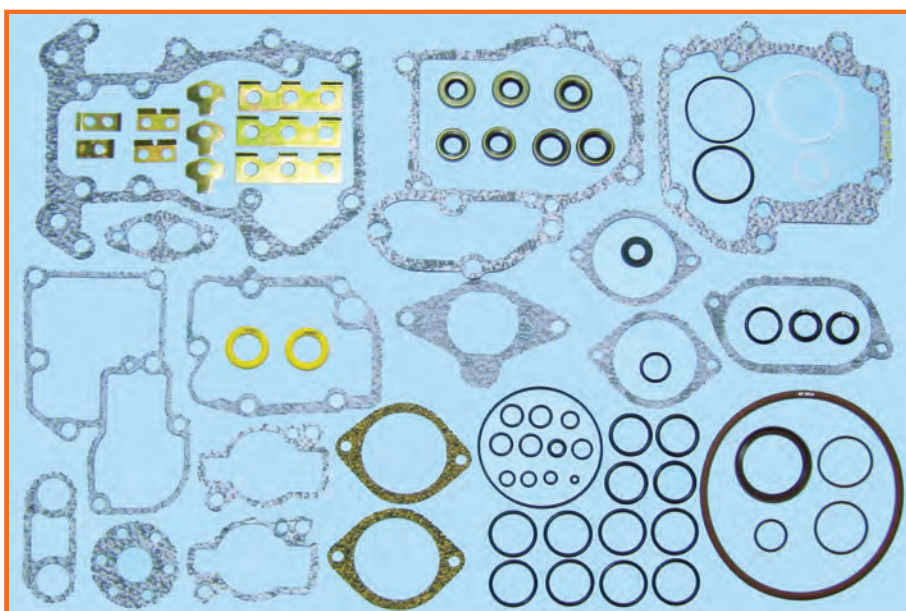

CODICE OMS 11-09-161

COD. Caterpillar 6V5920

COD.

COD.

COD.

TIPO-TYPE



CODICE OMS 11-09-162

COD. Caterpillar 5P9641

COD.

COD.

COD.

TIPO-TYPE

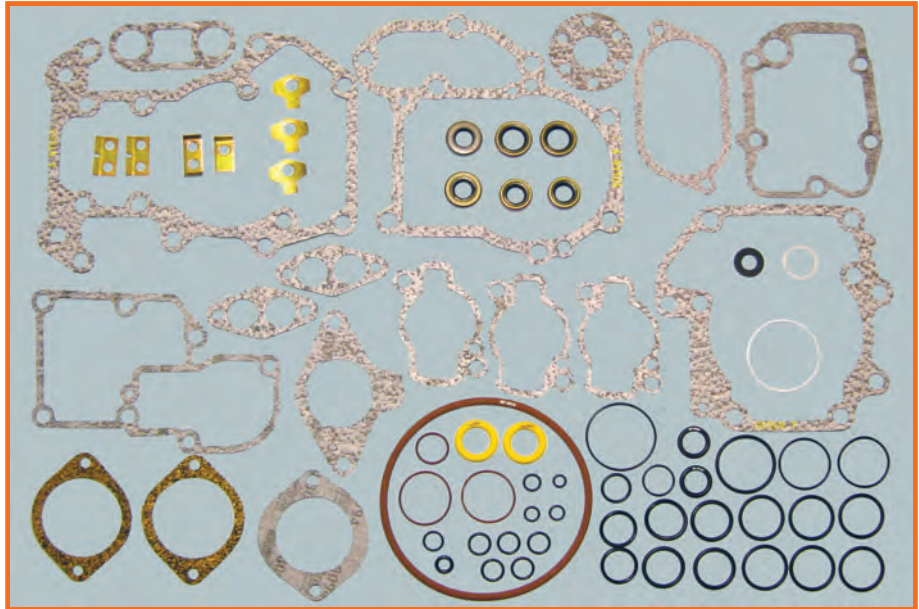

CODICE OMS 11-09-163

COD. Caterpillar 6V3729

COD.

COD.

COD.

TIPO-TYPE

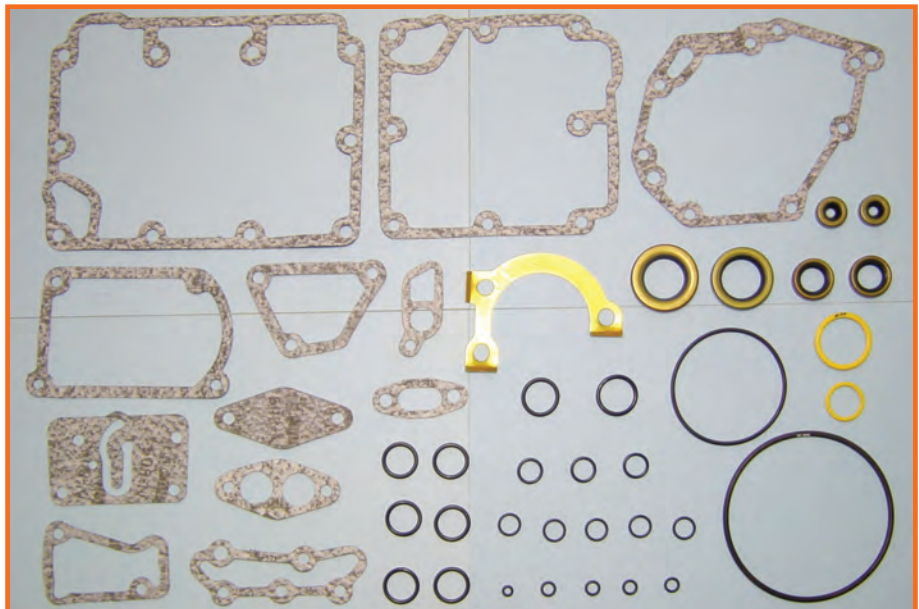

CODICE OMS 11-09-164

COD. Stanadyne 33702

COD.

COD.

COD.

TIPO-TYPE



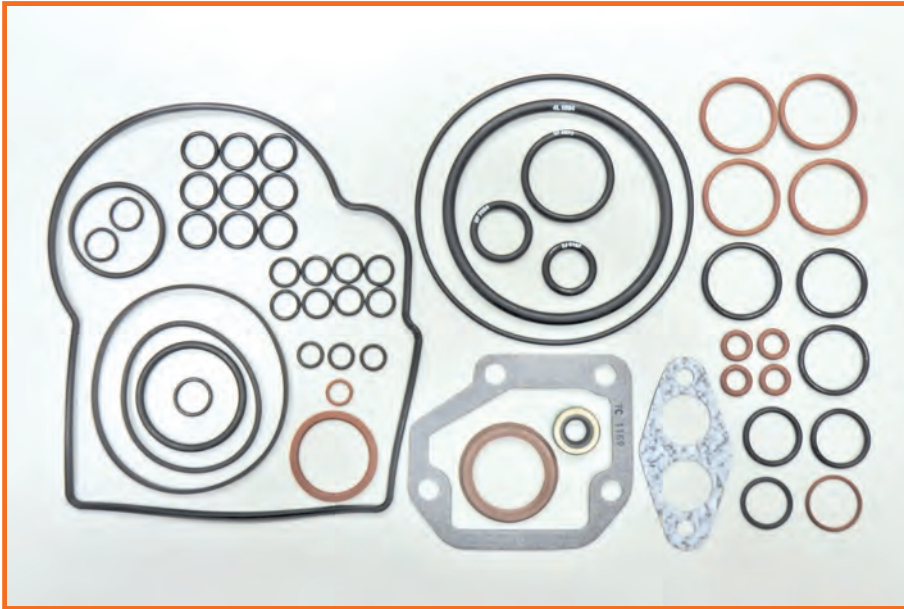

CODICE OMS 11-09-165

COD. Caterpillar 4P5502=7X2853

COD.

COD.

COD.

TIPO-TYPE

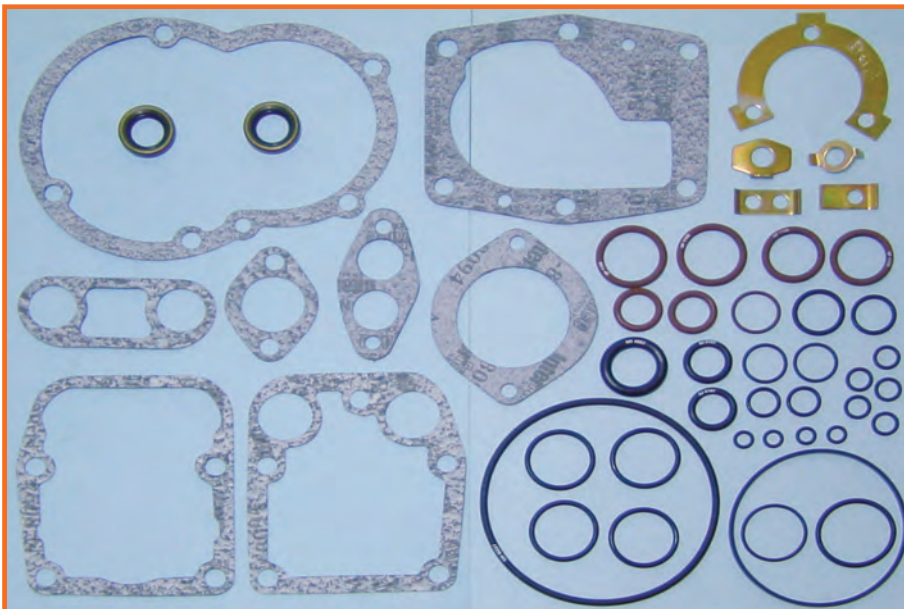

CODICE OMS 11-09-166

COD. Caterpillar 6V4720

COD.

COD.

COD.

TIPO-TYPE



CODICE OMS 11-09-167

COD. Lucas 7135-277F

COD.

COD.

COD.

TIPO-TYPE



CODICE OMS 11-09-168

COD. Caterpillar 6V4708

COD.

COD.

COD.

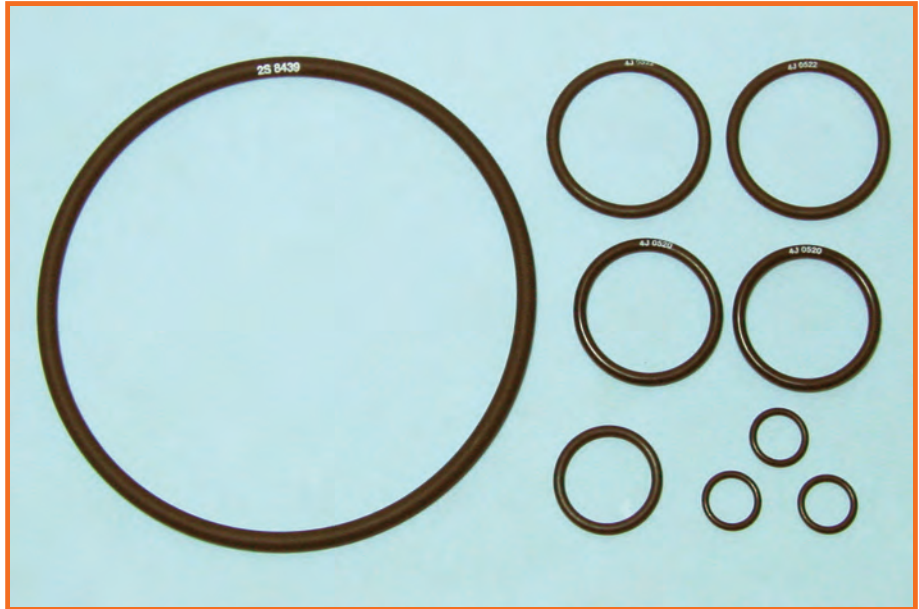

TIPO-TYPE

CODICE OMS 11-09-169

COD. Lucas 7135-539

COD.

COD.

COD.

Delphi

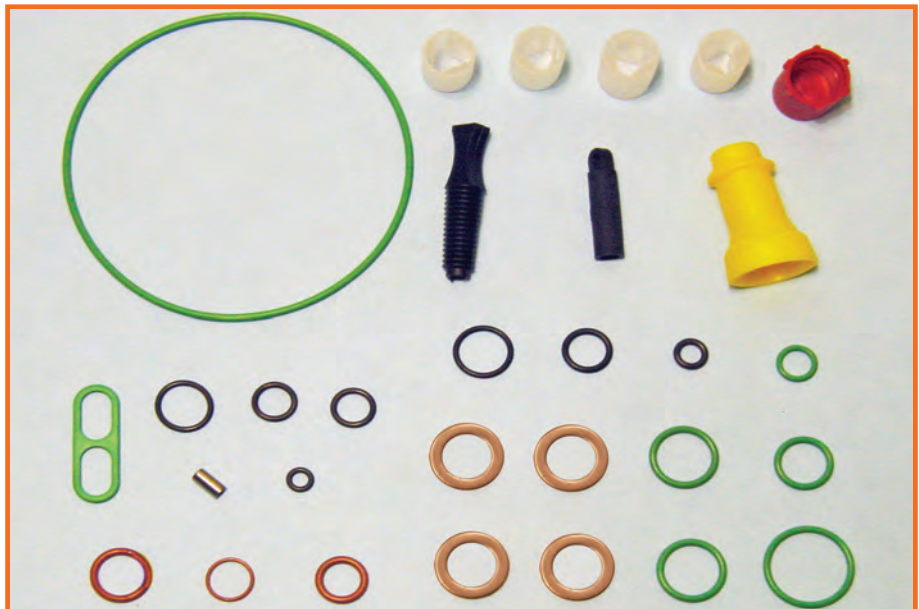

TIPO-TYPE

CODICE OMS 11-09-170

COD. Caterpillar 6V9908

COD.

COD.

COD.

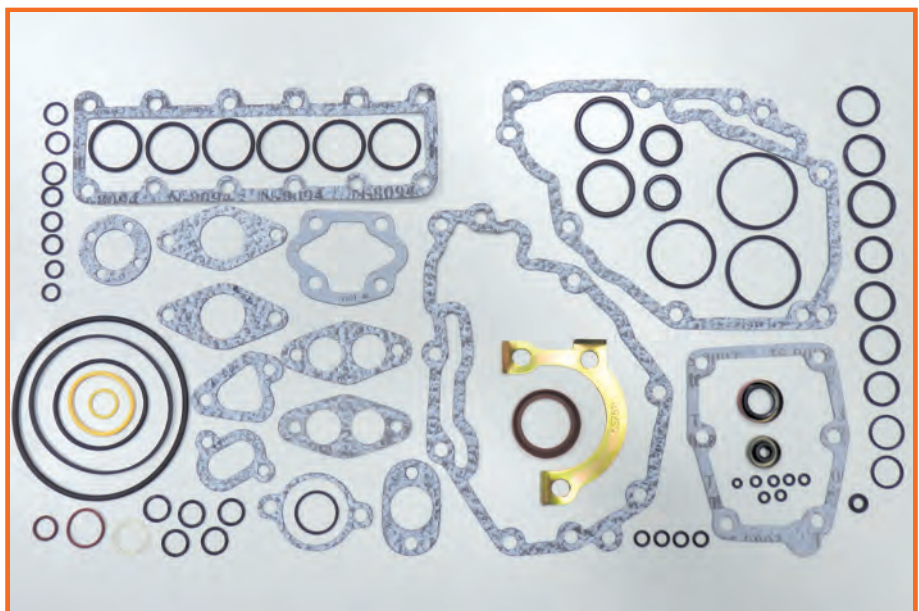

TIPO-TYPE



CODICE OMS 11-09-171

COD. Caterpillar 7x2853

COD.

COD.

COD.

TIPO-TYPE



CODICE OMS 11-09-172

COD. DGK510

COD.

COD.

COD.

TIPO-TYPE PE(S)6P..7100.



CODICE OMS 11-09-173

COD. 7135-277K

COD.

COD.

COD.

TIPO-TYPE DELPHI



CODICE OMS 11-09-174

COD. 7135-269

COD.

COD.

COD.



TIPO-TYPE DELPHI

CODICE OMS 11-09-175

COD. 9109-770

COD.

COD.

COD.

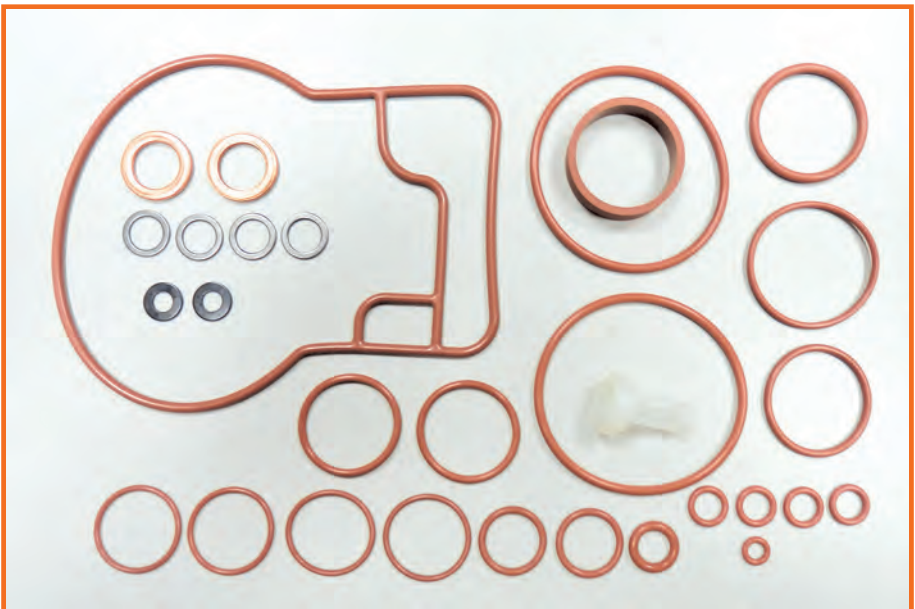

TIPO-TYPE DELPHI

CODICE OMS 11-09-176

COD. 9109-724

COD.

COD.

COD.



TIPO-TYPE DELPHI



CODICE OMS 11-09-177

COD. 7135-485

COD.

COD.

COD.

TIPO-TYPE DELPHI



CODICE OMS 11-09-178

COD. 7135-543

COD.

COD.

COD.

TIPO-TYPE DELPHI



CODICE OMS 11-09-179

COD. 7135-497

COD.

COD.

COD.

TIPO-TYPE DELPHI



CODICE OMS 11-09-180

COD. 7135-544

COD.

COD.

COD.



TIPO-TYPE DELPHI

CODICE OMS 11-09-181

COD. 9307-020A

COD.

COD.

COD.



TIPO-TYPE DELPHI

CODICE OMS 11-09-182

COD. 9x2519

COD.

COD.

COD.



TIPO-TYPE CATERPILLAR



CODICE OMS 11-09-183

COD. 7135-277K

COD.

COD.

COD.

TIPO-TYPE



CODICE OMS 11-09-184

COD. 33814

COD.

COD.

COD.

TIPO-TYPE POMPE DB2



CODICE OMS 11-09-185

COD. 7135-277C

COD.

COD.

COD.

TIPO-TYPE DELPHI DP 200



CODICE OMS 11-09-186

COD. 7135-277D

COD.

COD.

COD.



TIPO-TYPE DELPHI DP 200

CODICE OMS 11-09-187

COD. Stanadyne 36476

COD.

COD.

COD.



TIPO-TYPE

CODICE OMS 11-09-108/1

COD. 7135-479A/1

COD.

COD.

COD.

Con paraolio 6x32x20



TIPO-TYPE

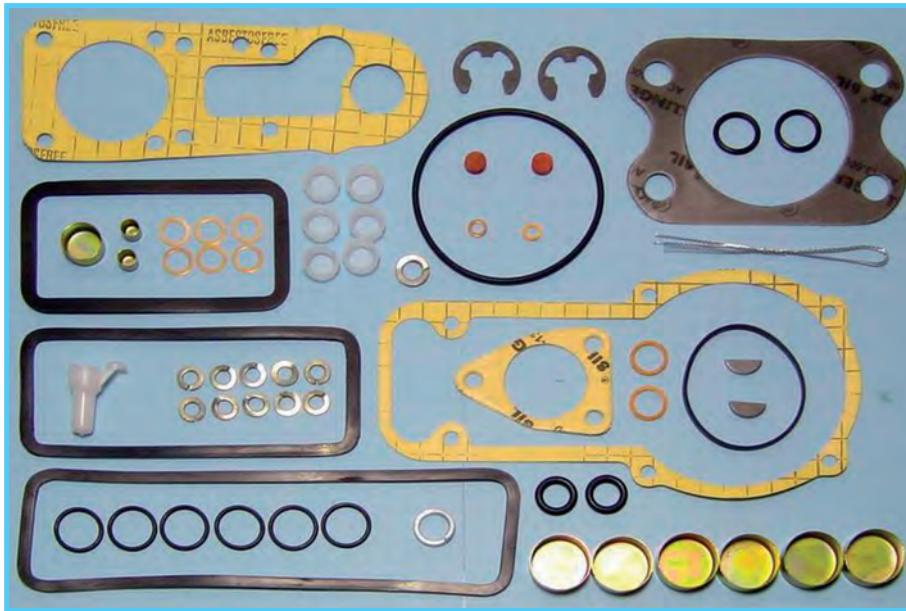

CODICE OMS 11-24-003

COD. KIT 3,4,6 CYL A/D PUMP

COD. _____

COD. _____

COD. _____

TIPO-TYPE

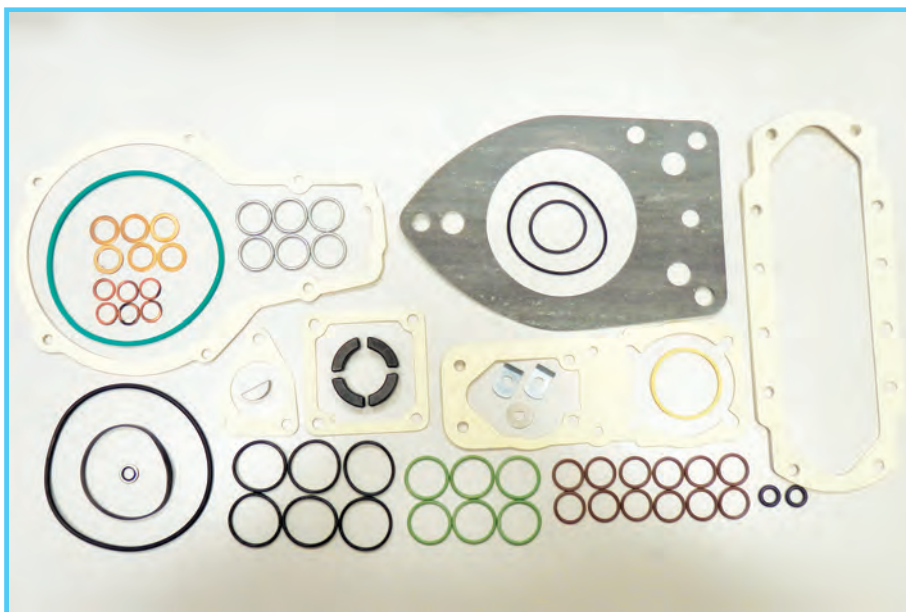

CODICE OMS 11-24-007

COD. MACK PUMP + GOVERNOR

COD. _____

COD. _____

COD. _____

TIPO-TYPE PE(S)6W..Std+RS/RQV



CODICE OMS 11-24-009

COD. ZEXEL

COD. _____

COD. _____

COD. _____

TIPO-TYPE VE type ZEXEL



CODICE OMS 02-40-001

Rosetta intermedia +
astina + molla + dado

2 430 134 023	Rosetta interm.
2 433 124 446	Astina
2 434 614 020	Molla
2 433 349 468	Dado

TIPO-TYPE KBAL 137P28



CODICE OMS 02-40-002

Rosetta intermedia +
astina + molla + dado

2 430 136 221	Rosetta interm.
2 433 124 377	Astina
2 434 614 055	Molla
2 433 349 306	Dado

TIPO-TYPE KBAL 137P174



CODICE OMS 02-40-003

Rosetta intermedia
+ astina + dado

SR780117	Rosetta interm.
GU780081	Astina
NT780118	Dado

TIPO-TYPE AMBAC:HNM780321 /AKN90M6425
STANADYNE:780321

CODICE OMS 02-40-004

Rosetta intermedia
+ astina + molla
rif. or. 9 431 080 032

2 430 136 191	Rosetta interm.
2 433 124 137	Astina
2 434 619 017	Molla

TIPO-TYPE Mercedes-Benz



CODICE OMS 02-40-005

Rosetta intermedia
+ astina + molla
rif. or. 9 431 080 033

2 430 136 166	Rosetta interm.
2 433 120 127	Astina
2 434 614 015	Molla

TIPO-TYPE Ford, Maxion, MWM, Volvo



CODICE OMS 02-40-006

Rosetta intermedia
+ astina + molla
rif. or. 9 431 080 034

2 430 136 085	Rosetta interm.
2 433 124 379	Astina
2 434 619 040	Molla

TIPO-TYPE Maxion, Scania



CODICE OMS 02-40-007

Rosetta intermedia
+ astina + molla
rif. or. 9 431 080 035

2 430 136 206	Rosetta interm.
2 433 124 137	Astina
2 434 619 010	Molla

TIPO-TYPE MWM



CODICE OMS 02-40-008

Molla + astina
+ rosetta intermedia
rif. or. F 000 431 057

2 430 136 202	Rosetta interm.
2 433 124 137	Astina
2 434 619 017	Molla

TIPO-TYPE MB

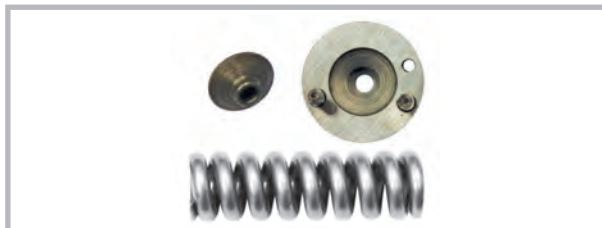

CODICE OMS 02-40-009

Molla + astina
+ rosetta intermedia
rif. or. F 000 431 058

2 430 136 166	Rosetta interm.
2 433 124 388	Astina
2 434 614 022	Molla

TIPO-TYPE MB

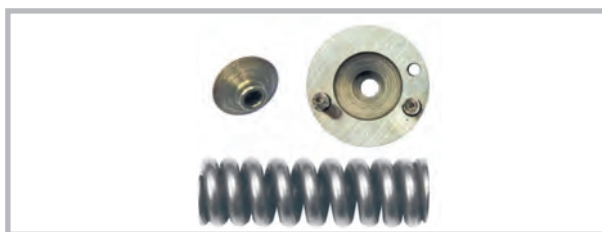

CODICE OMS 02-40-010

Molla + astina
+ rosetta intermedia
rif. or. F 000 431 059

2 430 136 166	Rosetta interm.
2 433 124 388	Astina
2 434 614 027	Molla

TIPO-TYPE Scania

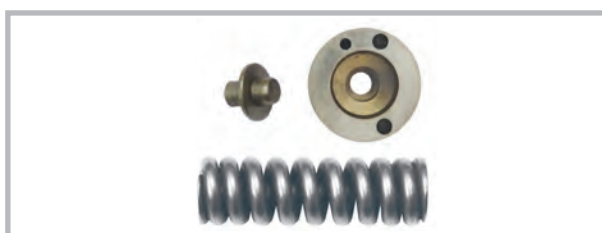

CODICE OMS 02-40-011

Molla + astina
+ rosetta intermedia
rif. or. F 000 431 060

2 430 136 206	Rosetta interm.
2 433 124 137	Astina
2 434 614 019	Molla

TIPO-TYPE MWM



CODICE OMS 02-40-012

Molla + astina
+ rosetta intermedia
rif. or. F 000 431 700

2 430 134 023	Rosetta interm.
2 433 124 446	Astina
2 434 614 020	Molla

TIPO-TYPE Cummins, Ford, Iveco, Fiat, MB, Mack, VW, CNH, Perkins

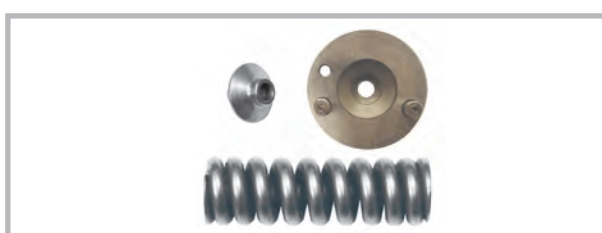

CODICE OMS 02-40-013

Molla + astina
+ rosetta intermedia
rif. or. F 000 431 701

2 430 136 212	Rosetta interm.
2 433 124 376	Astina
2 434 614 040	Molla

TIPO-TYPE MB, Iveco, Perkins, Scania, VW e CNH

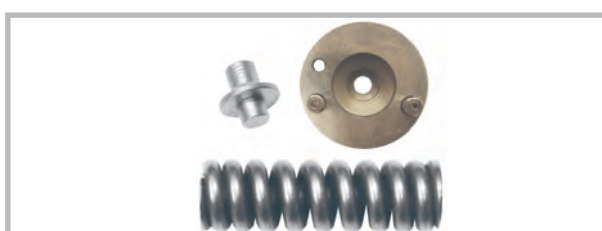

CODICE OMS 02-40-014

Molla + astina
+ rosetta intermedia
rif. or. F 000 431 702

F 018 B06 804	Rosetta interm.
F 00Z B20 001	Astina
2 434 614 040	Molla

TIPO-TYPE Scania



CODICE OMS 11-23-080

COD. _____

COD. _____

COD. _____

COD. _____

Kit per Mercedes-Man (13 mm)



TIPO-TYPE

CODICE OMS 11-23-081

COD. _____

COD. _____

COD. _____

COD. _____

Kit per Mercedes-Man (9 mm)



TIPO-TYPE

CODICE OMS 11-23-082

COD. _____

COD. _____

COD. _____

COD. _____

Kit per Mercedes-Man (9 mm)

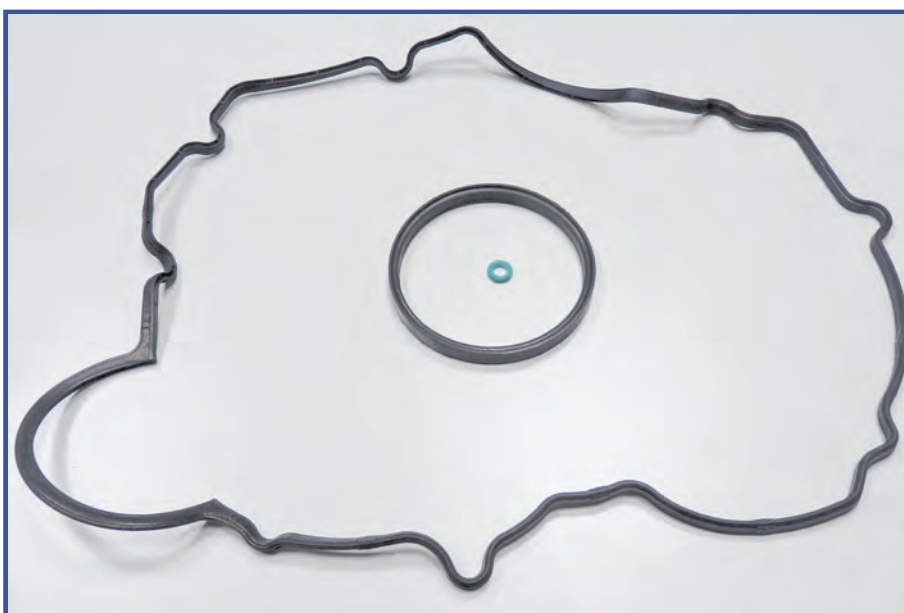

TIPO-TYPE

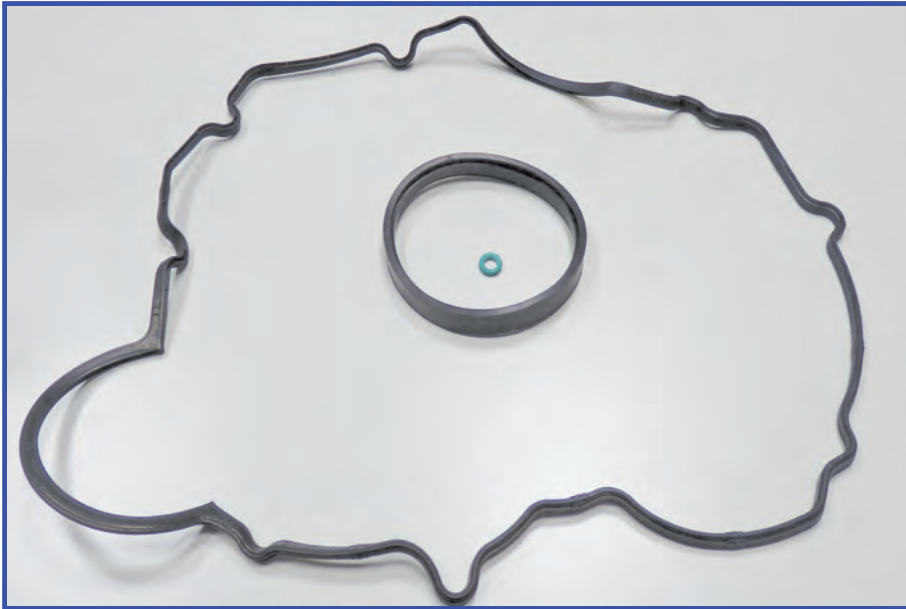

CODICE OMS 11-23-082/1

COD. _____
COD. _____
COD. _____
COD. _____

Kit per Mercedes-Man (13 mm)

TIPO-TYPE

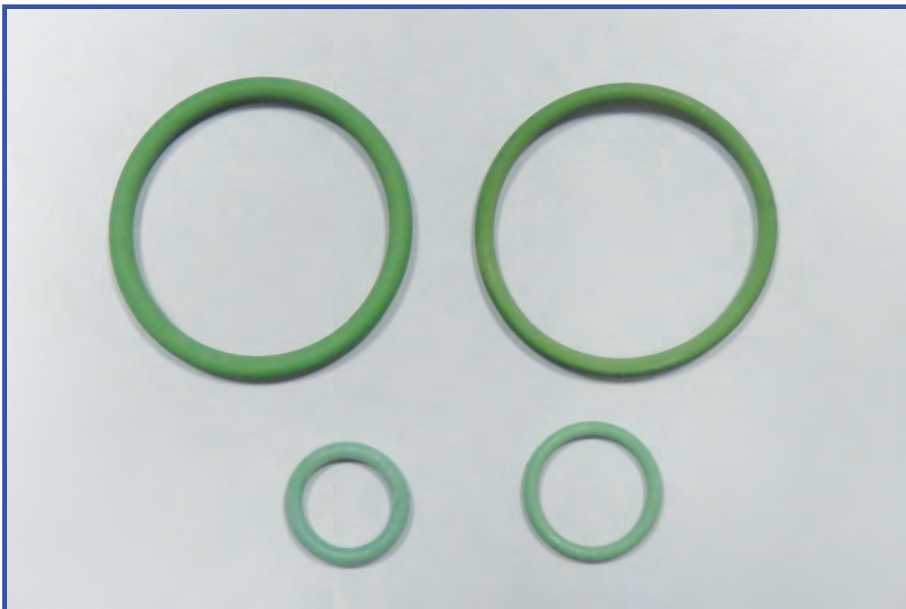

CODICE OMS 11-23-100

COD. _____
COD. _____
COD. _____
COD. _____

Kit per tenuta solenoide
Volkswagen

TIPO-TYPE PDE 80

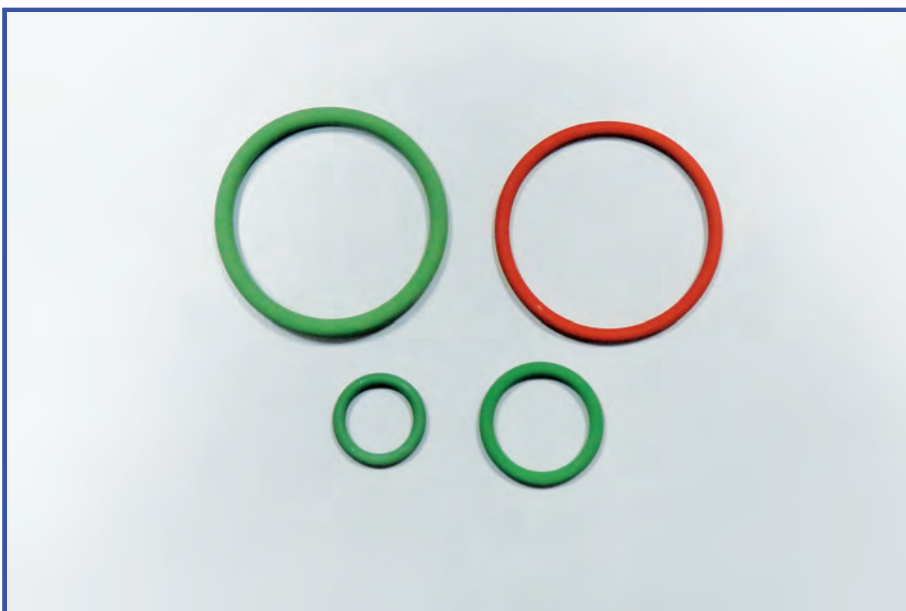

CODICE OMS 11-23-101

COD. _____
COD. _____
COD. _____
COD. _____

Kit per tenuta esterna
Volkswagen

TIPO-TYPE PDE 80



CODICE OMS 11-23-102

KIT SPINE ALLINEAMENTO
 \varnothing 1,5x24 mm
 N°100 pezzi per sacchetto



TIPO-TYPE PDE 80

CODICE OMS 11-23-120

KIT MERCEDES ATEGO
 SENZA PIASTRA
 Bh F 00H N37 070
 Mercedes 012 074 01 01

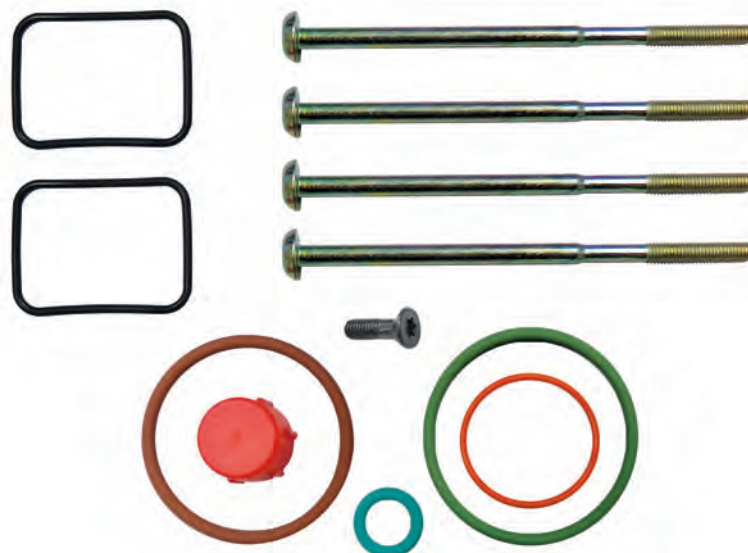

TIPO-TYPE PLD 100

CODICE OMS 11-23-120/1

KIT MERCEDES ATEGO
 CON PIASTRA
 Bh F 00H N37 070
 Mercedes 012 074 01 01

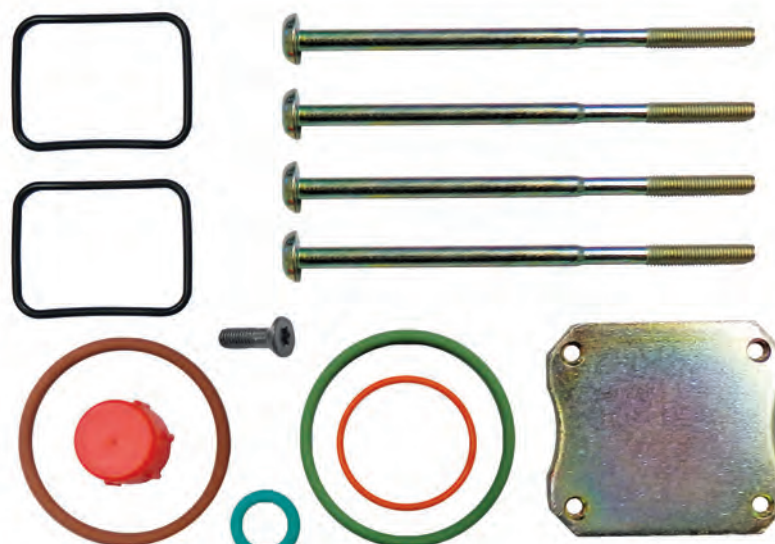

TIPO-TYPE PLD

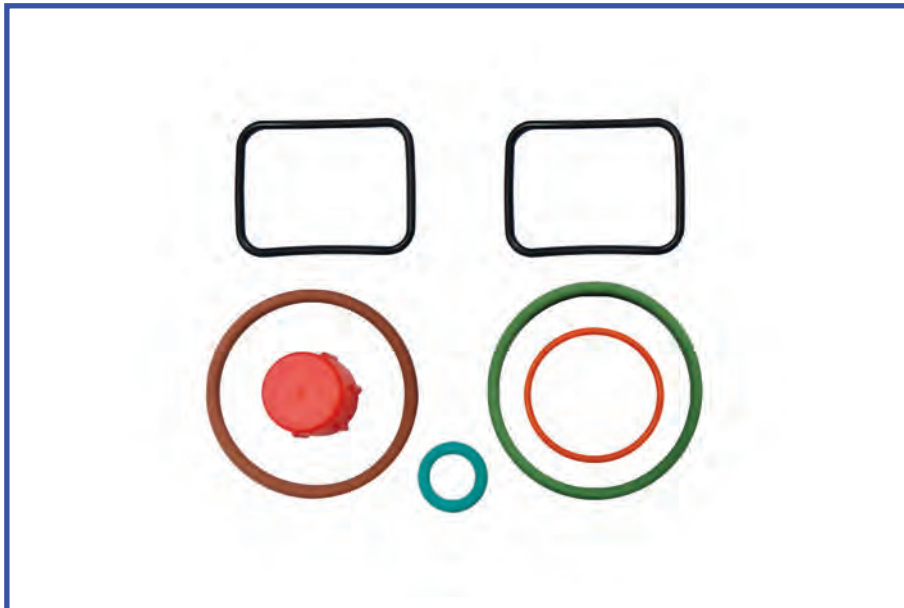

CODICE OMS 11-23-120/2

KIT MERCEDES ATEGO
SENZA VITI E PIASTRA
Bh F 00H N37 070
Mercedes 012 074 01 01

TIPO-TYPE PLD

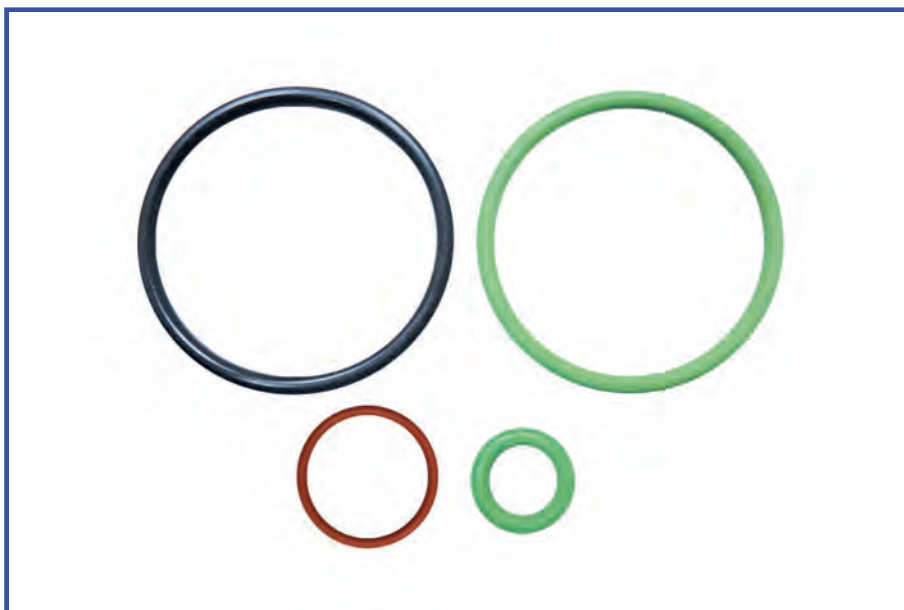

CODICE OMS 11-23-121

KIT TENUTA
ESTERNA PER ATEGO

TIPO-TYPE PLD

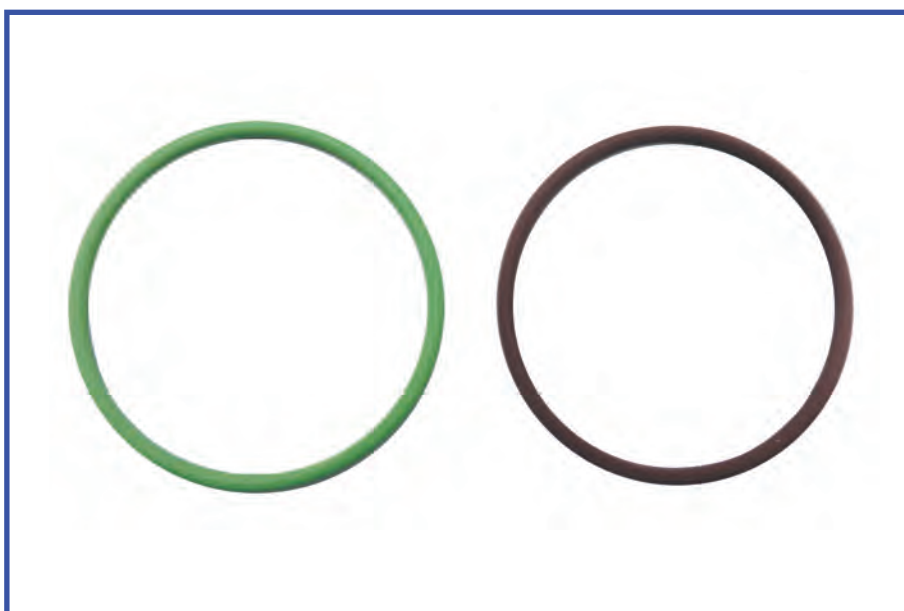

CODICE OMS 11-23-122

KIT TENUTA
ESTERNA PER ACTROS

TIPO-TYPE PLD



CODICE OMS 11-23-140/1

GASKET KIT

Bh F 00H N37 928
+
Bh F 00V X99 992

KIT 11-23-140 PAG. 254

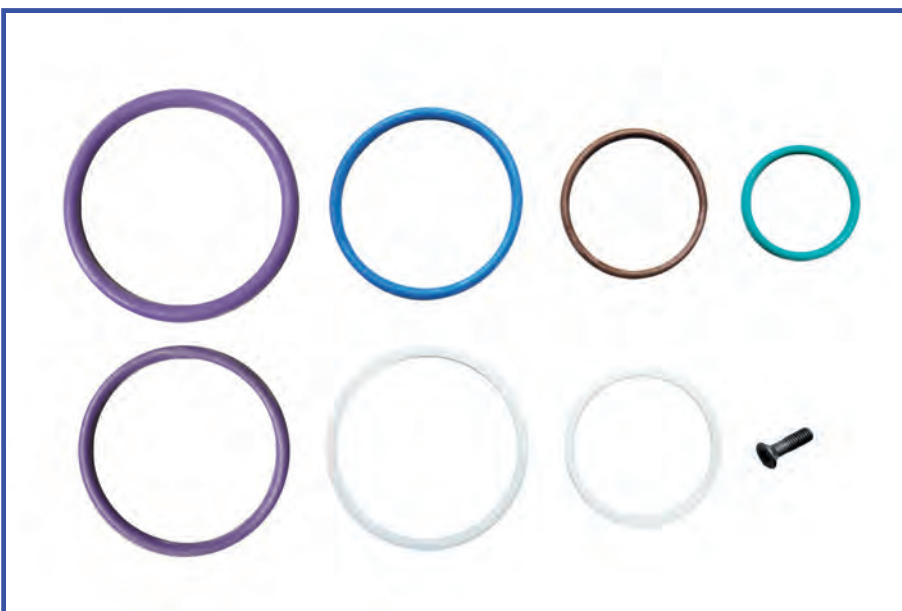

TIPO-TYPE PDE 100

CODICE OMS 11-23-141/1

GASKET KIT

Bh F 00H 4S0 002
+
Bh F 00H N37 928

KIT 11-23-141 PAG. 254

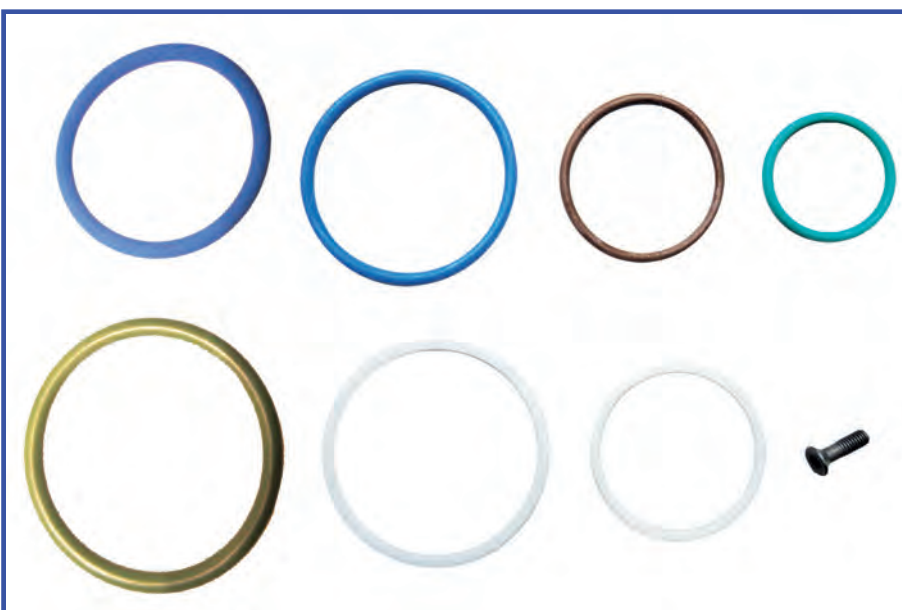

TIPO-TYPE PDE 100

CODICE OMS 11-23-144

KIT O-RING TENUTA
ESTERNA PER VOVLO

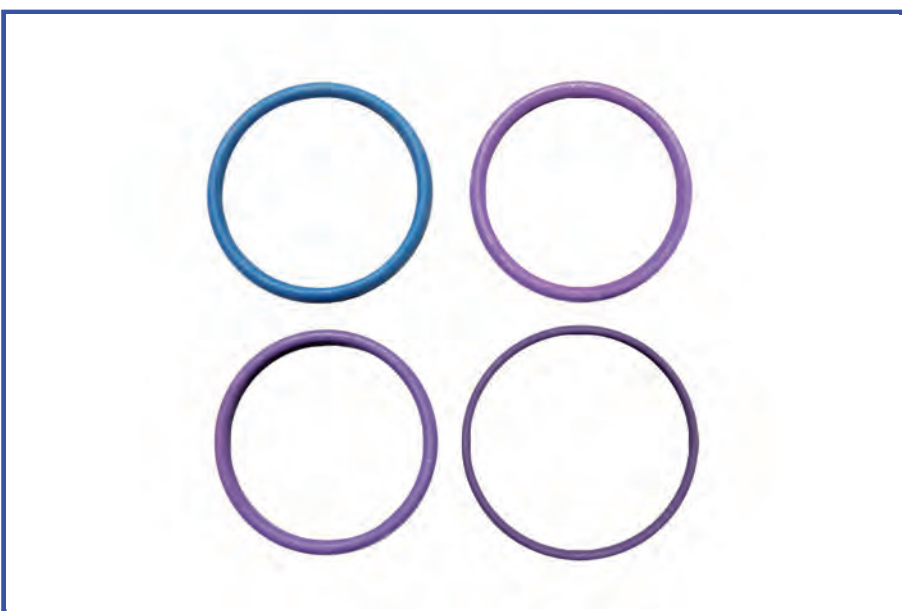

TIPO-TYPE PDE 90/100



11-23-***

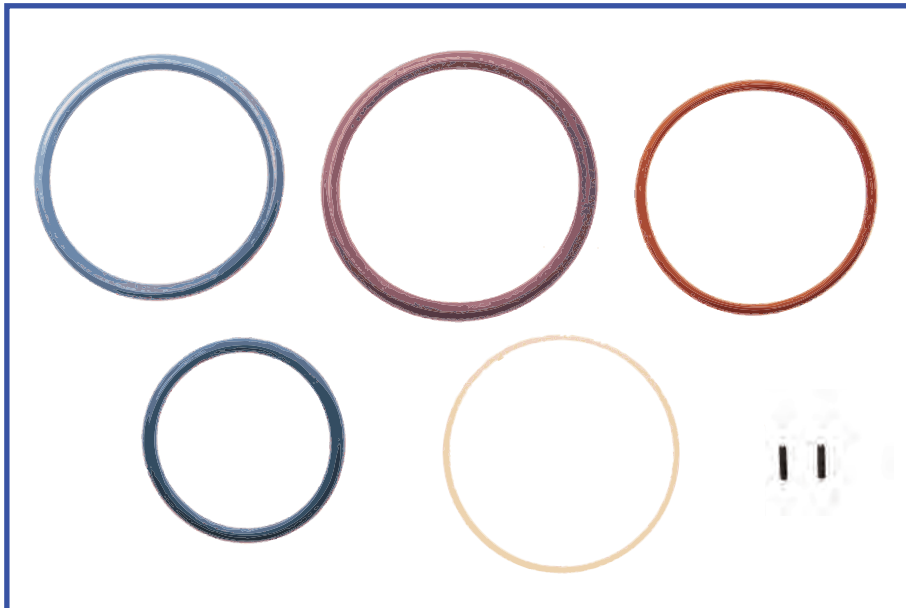

CODICE OMS 11-23-145

KIT O-RING TENUTA
ESTERNA PER SCANIA

TIPO-TYPE PDE 90/100

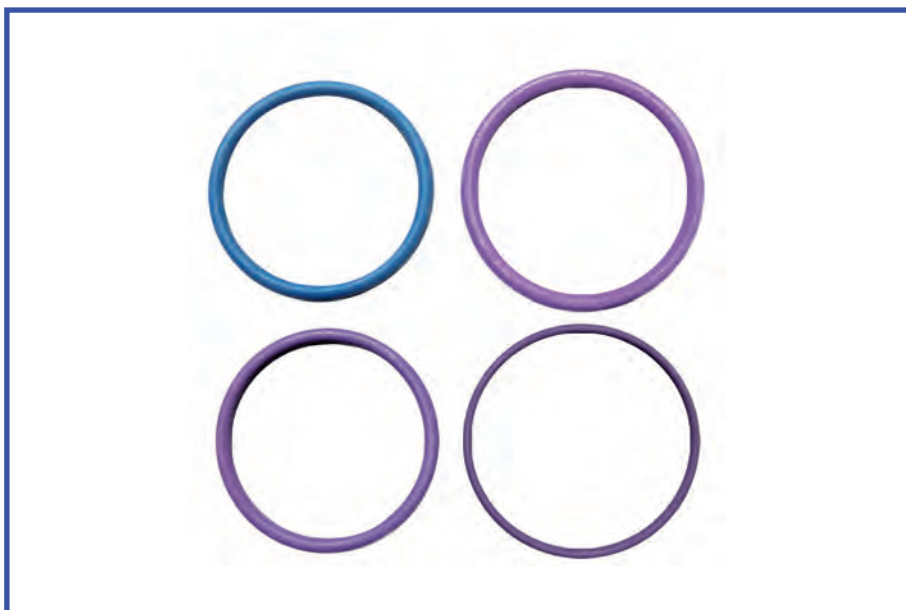

CODICE OMS 11-23-161

KIT PER TENUTA
ESTERNA

TIPO-TYPE DELPHI EUI

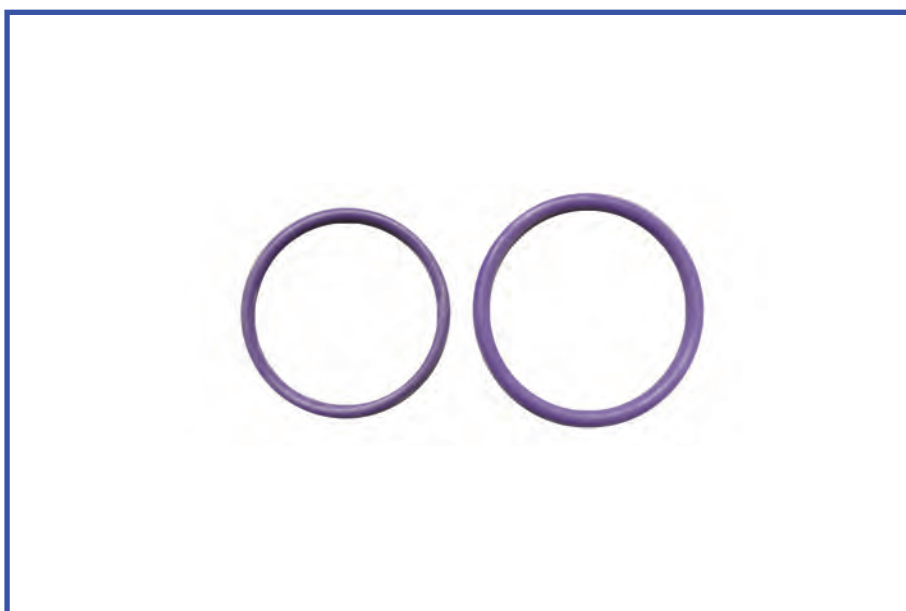

CODICE OMS 11-23-162

KIT TENUTA ESTERNA
VOLVO FH 12 460 HP
Bh F 00V X99 992

TIPO-TYPE PDE 100



CODICE OMS 11-23-180

KIT ANELLO DI TENUTA 7
MM CON O-RING
PARAOLIO 20x32x7 VAITON



TIPO-TYPE CP3

CODICE OMS 11-23-181

KIT ANELLO DI TENUTA
CON O-RING
PARAOLIO 25x37x7 VAITON



TIPO-TYPE CP3

CODICE OMS 11-23-182

KIT TENUTA
Con n°2 paraoli e sfere
25x36x7
25x37x7



TIPO-TYPE CP3 110



11-23-***



CODICE OMS 11-23-182/1

KIT TENUTA
Con n°3 paraoli e sfere
25x36x7
25x37x7
10x18,8x5,2

TIPO-TYPE CP3 110



CODICE OMS 11-23-182/2

KIT TENUTA
Con n°3 paraoli

Vedi KIT 11-23-182/3
con n°4 paraoli a pag. 254

TIPO-TYPE CP3 70

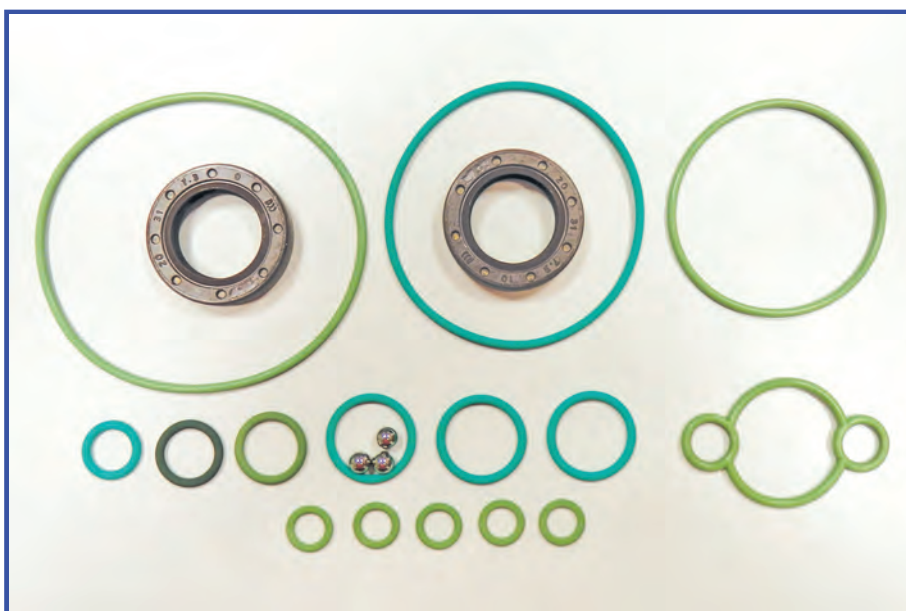

CODICE OMS 11-23-183

KIT TENUTA
F 00N 201 974
Con n°2 paraoli
20x31x7

TIPO-TYPE CP3 70



CODICE OMS 11-23-183/1

KIT TENUTA
 F 00N 201 973
 F 00N 201 974
 F 00N 201 975
 F 00N 201 976
 Con n°3 paraoli



TIPO-TYPE CP3 UNIVERSAL

CODICE OMS 11-23-183/3

KIT TENUTA

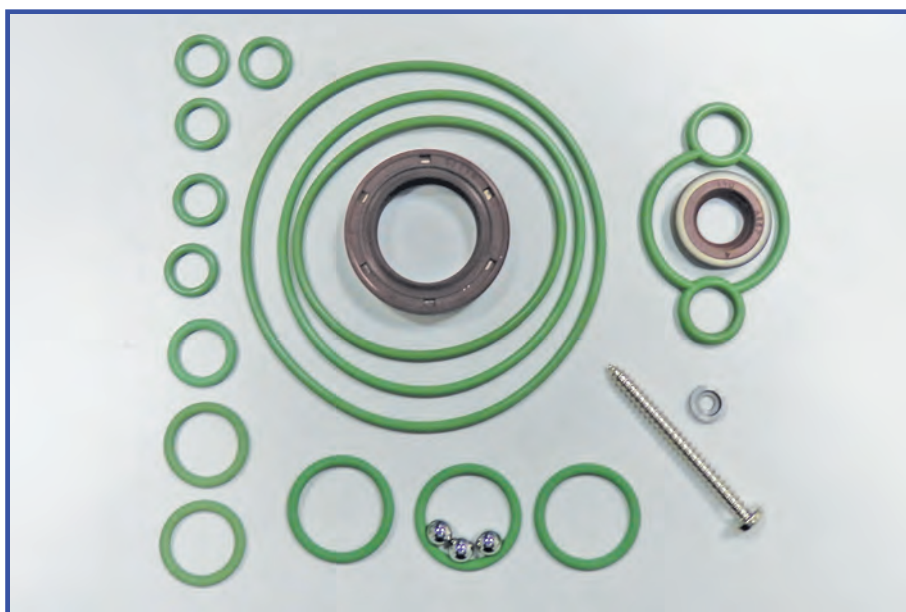

TIPO-TYPE CP3 UNIVERSAL

CODICE OMS 11-23-184

KIT TENUTA
 VOLKSWAGEN
 Paraolio 20x31x7

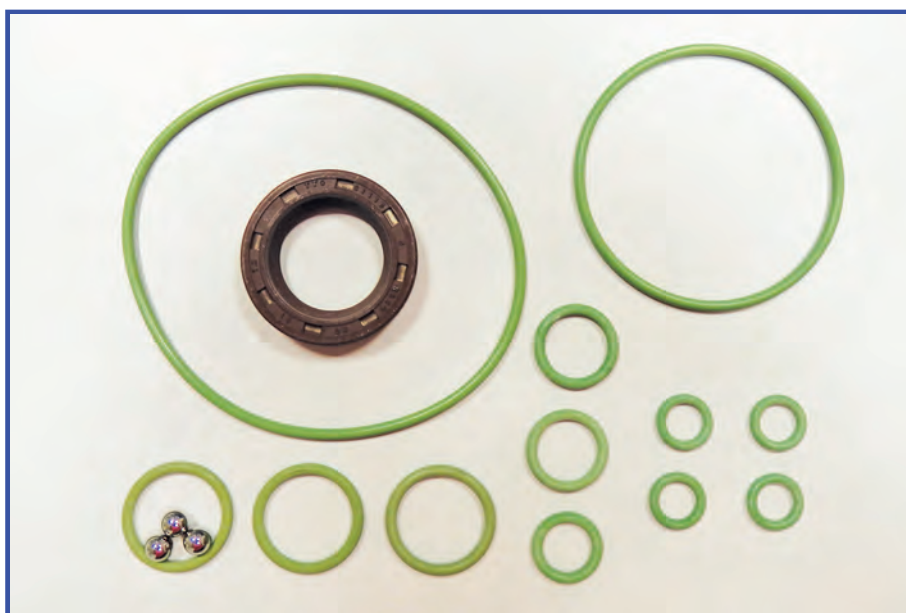

TIPO-TYPE CP3 70/89



11-23-***



CODICE OMS 11-23-184/1

KIT TENUTA
VOLKSWAGEN
Con sfere, vite e scodellino
paraolio 20x31x7

TIPO-TYPE CP3 70/89

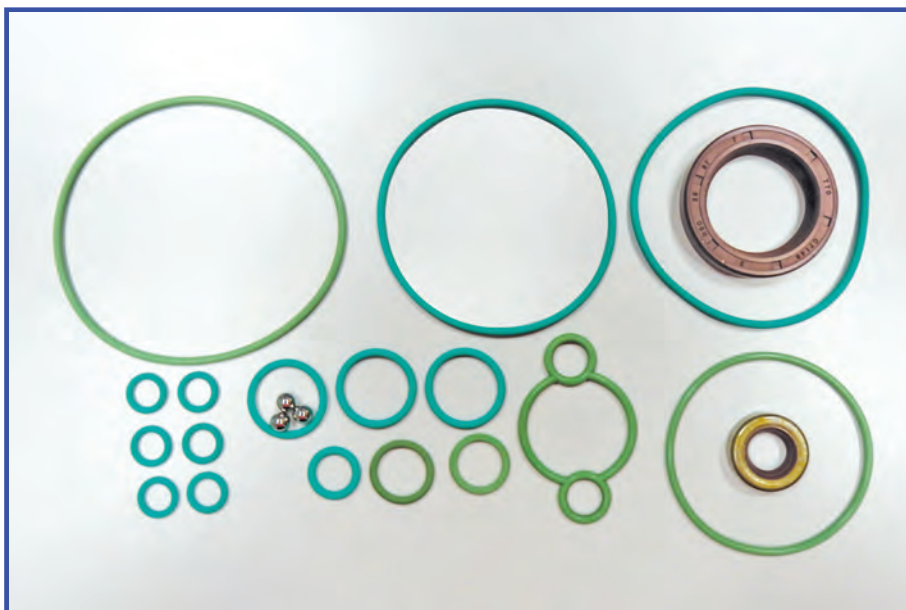

CODICE OMS 11-23-185

KIT TENUTA
F 00N 201 975
Con n°2 paraoli e sfere

25x37x7
10x18,8x5,2

TIPO-TYPE CP3 80

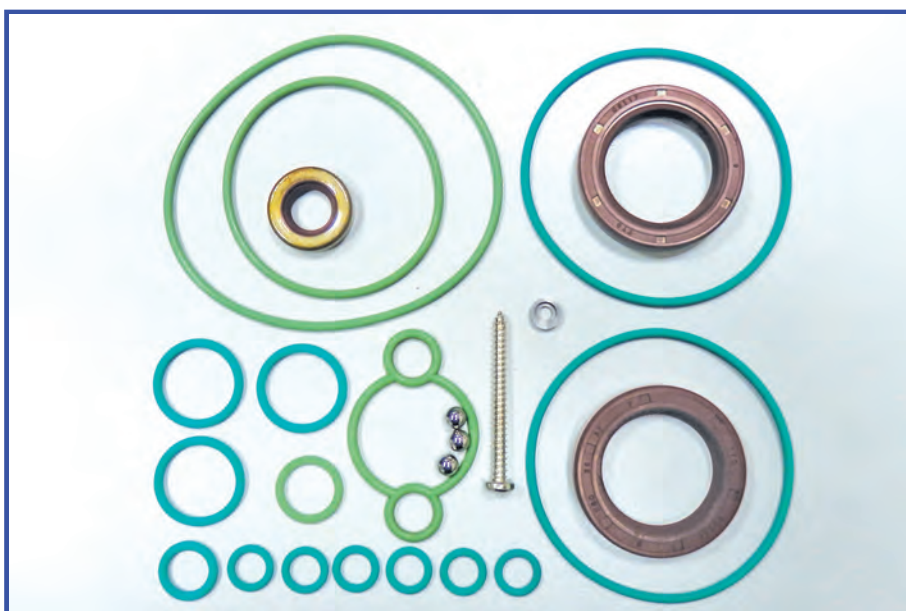

CODICE OMS 11-23-185/1

KIT TENUTA
F 00N 201 975
Con n°3 paraoli ,sfere, vite
e scodellino

25x37x7
10x18,8x5,2
25x36x7,5

TIPO-TYPE CP3 80

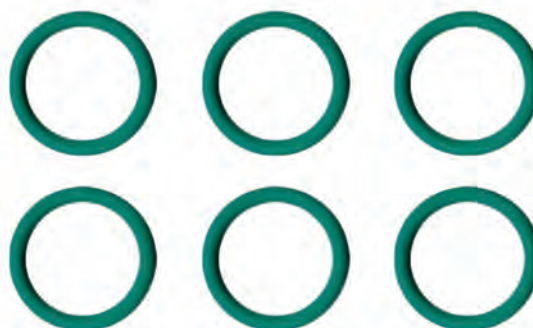

CODICE OMS 11-23-186

PER INIETTORI CUMMINS
N°6 o-ring

TIPO-TYPE

CODICE OMS 11-23-187

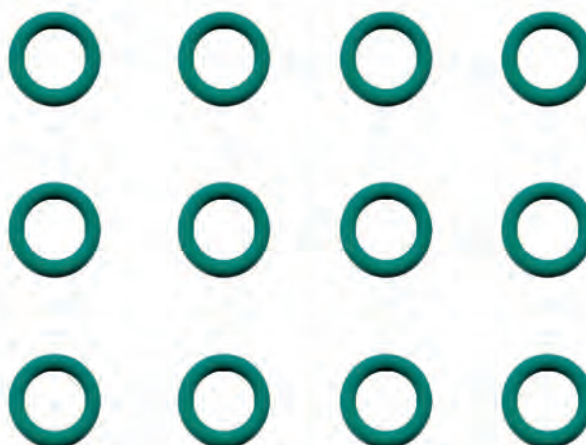
PER INIETTORI IVECO
N°12 o-ring

TIPO-TYPE

CODICE OMS 11-23-188

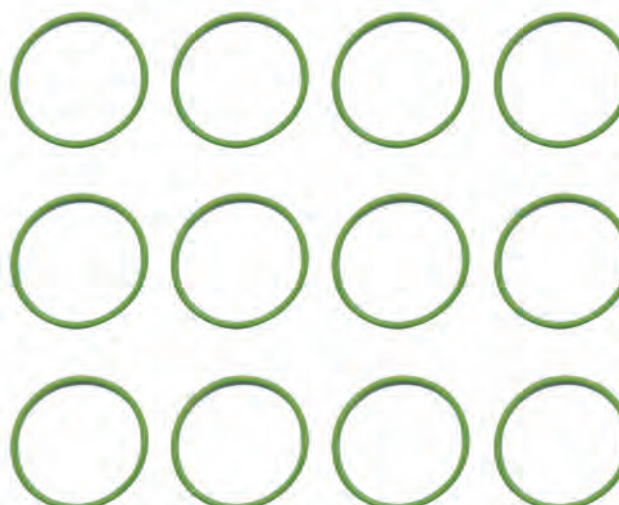
PER SOLENOIDE CUMMINS
N°12 o-ring

TIPO-TYPE



11-23-***

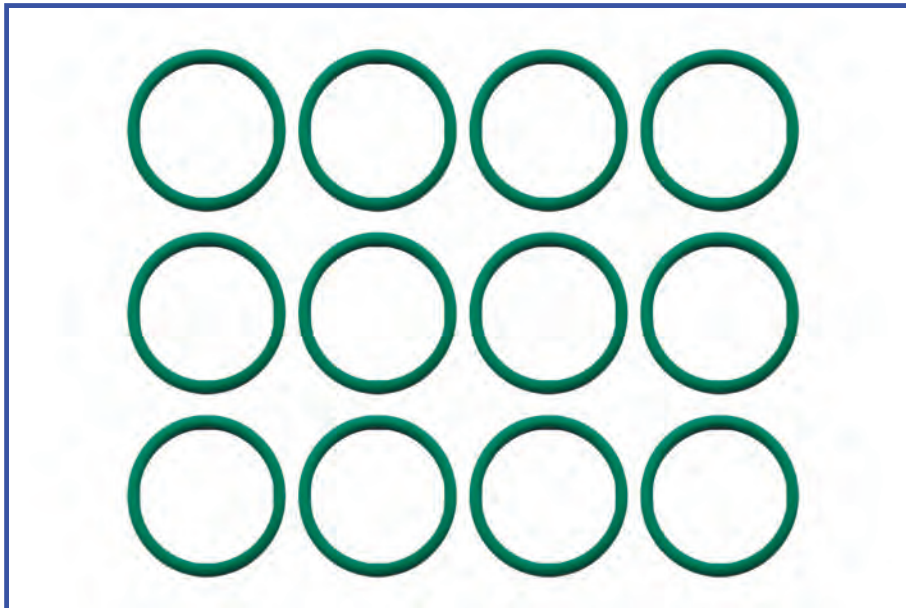

CODICE OMS 11-23-189

PER INIETTORI
RENAULT 420 HP
N°12 o-ring

TIPO-TYPE



CODICE OMS 11-23-190

1°SERIE KIT TENUTA
Equivalente a / suitable to
Bh F 01M 100 275
Bh F 01M 101 454
+ N°1 paraolio 20x31x7
in viton

TIPO-TYPE CP1



CODICE OMS 11-23-191

IVECO DAILY
Con n°2 paraolio 20x31x7
e o-ring

TIPO-TYPE CP1

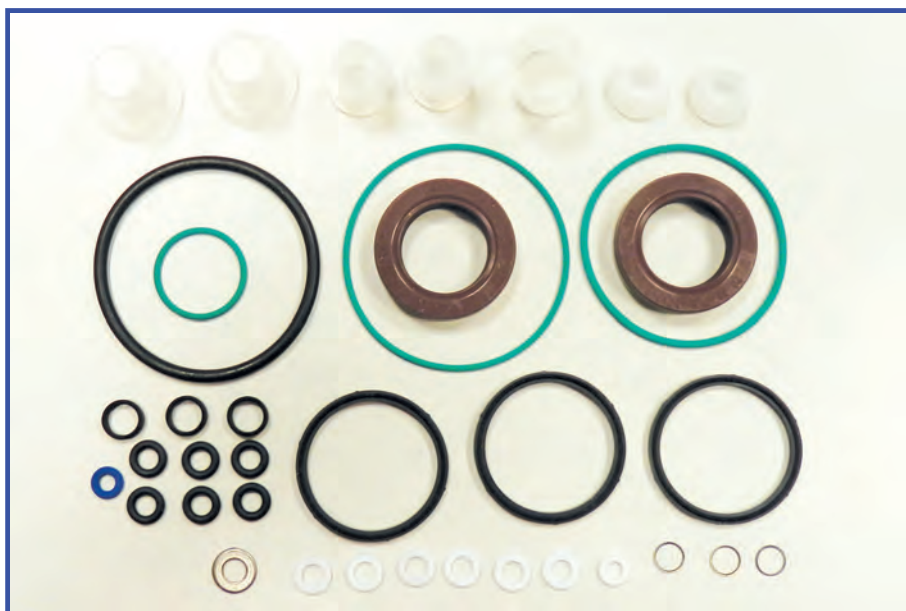

CODICE OMS 11-23-192

Equivalente a / suitable to
 Bh F 01M 100 277
 Bh F 01M 101 456
 IVECO, MERCEDES, KIA
 + N°2 paraoli 20x31x7

TIPO-TYPE CP1 (EVO)

CODICE OMS 11-23-193

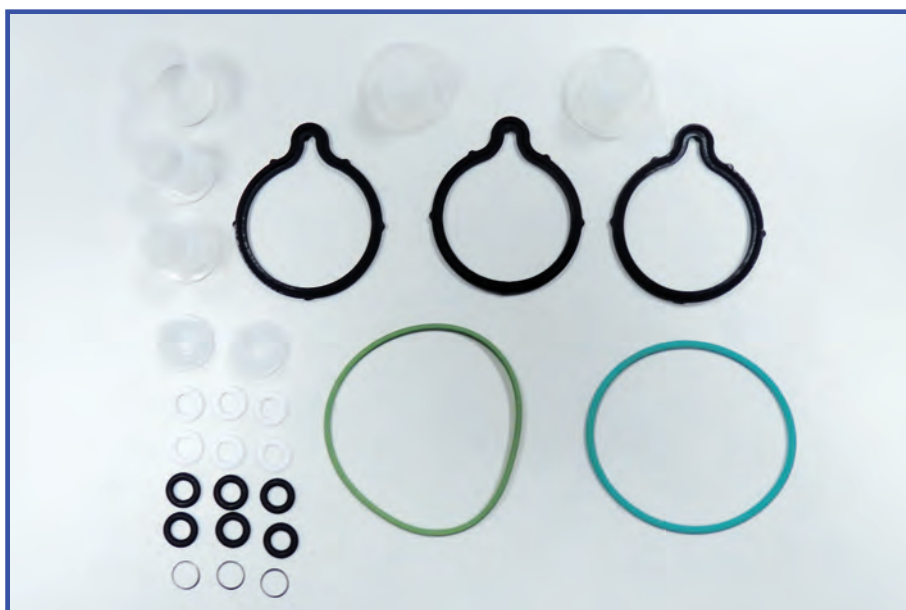
COD. Bh F 01M 100 275
 Bh F 01M 101 454

TIPO-TYPE CP1

CODICE OMS 11-23-194

COD. Bh F 01M 100 276
 Bh F 01M 101 455

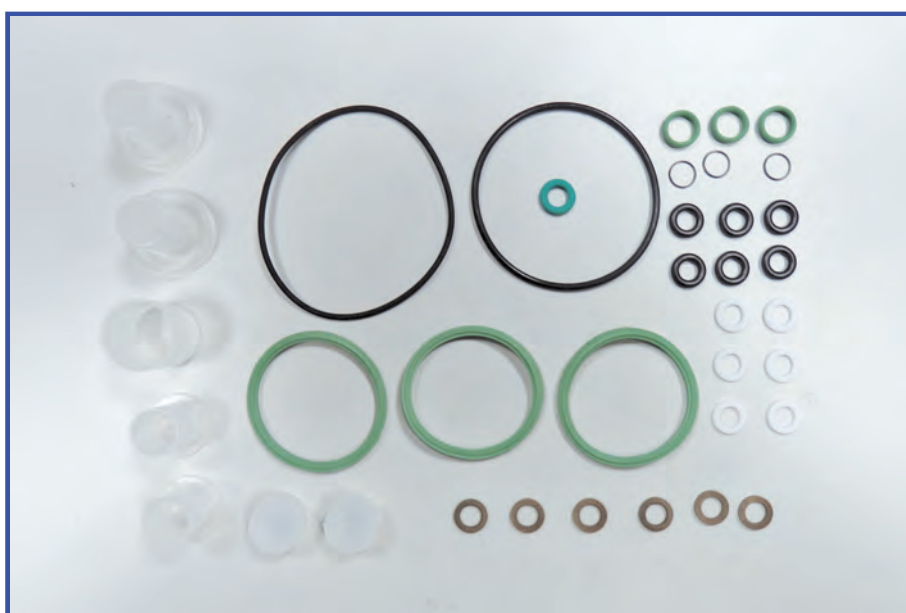

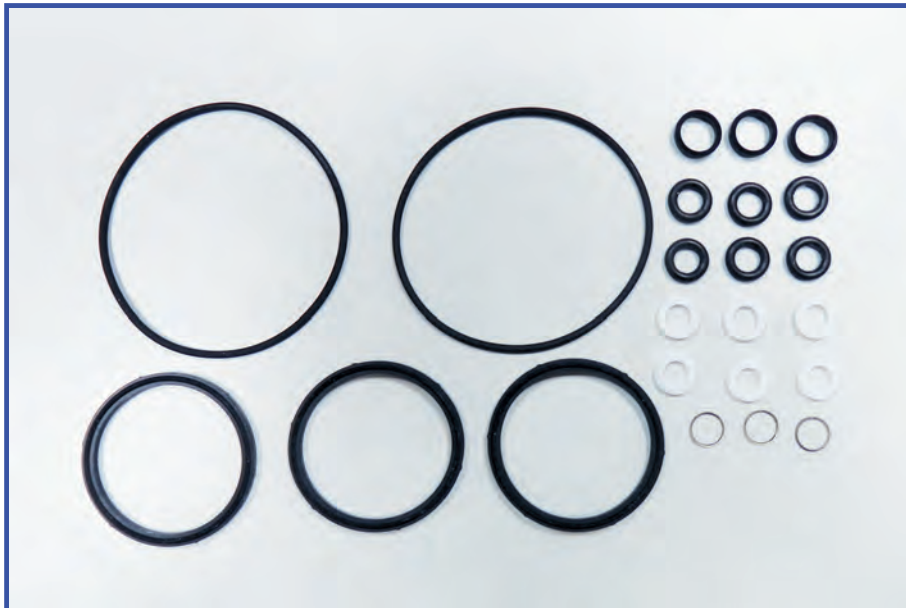
TIPO-TYPE CP1



CODICE OMS 11-23-194/1

COD. Bh F 01M 101 455
Light version

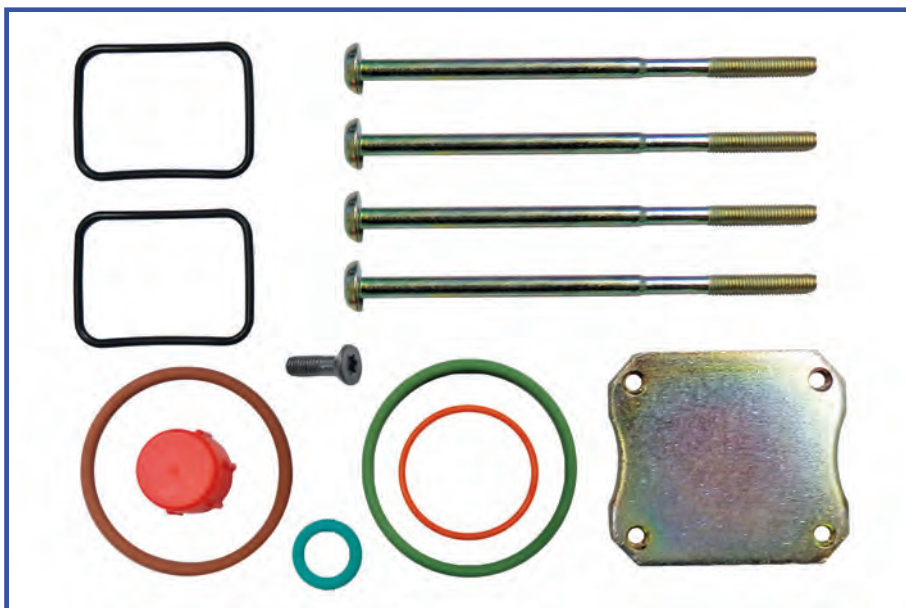
TIPO-TYPE



CODICE OMS 11-23-195

COD. Bh F 00H N37 069
KIT MERCEDES
ACTROS - AXOR - CITARO
Con piastra

TIPO-TYPE PLD 1D 110/520

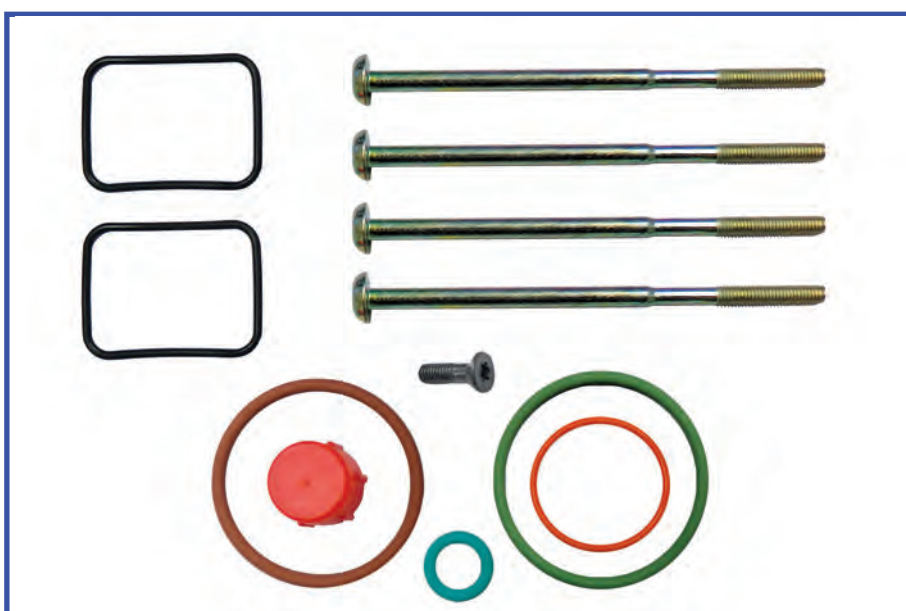

CODICE OMS 11-23-195/1

COD. Bh F 00H N37 069
KIT MERCEDES
ACTROS - AXOR - CITARO
Senza piastra

TIPO-TYPE PLD 1D 110/520



CODICE OMS 11-23-195/2

COD. Bh F 00H N37 069
KIT MERCEDES
ACTROS - AXOR - CITARO
Senza viti e piastra

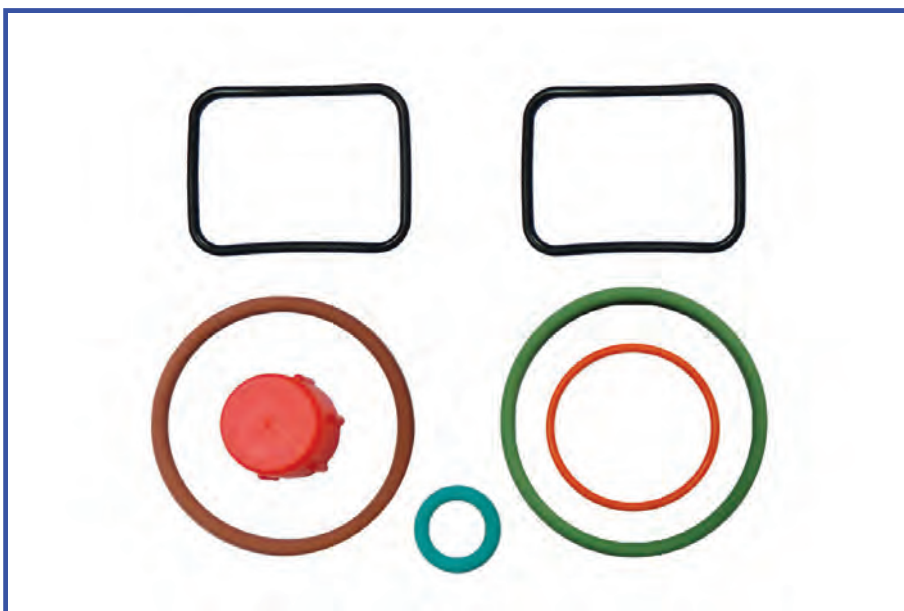

TIPO-TYPE PLD 1D 110/520

CODICE OMS 11-23-195/3

COD. Bh F 00H N37 069
KIT MERCEDES
ACTROS - AXOR - CITARO
Senza viti e piastra
con parafiamma

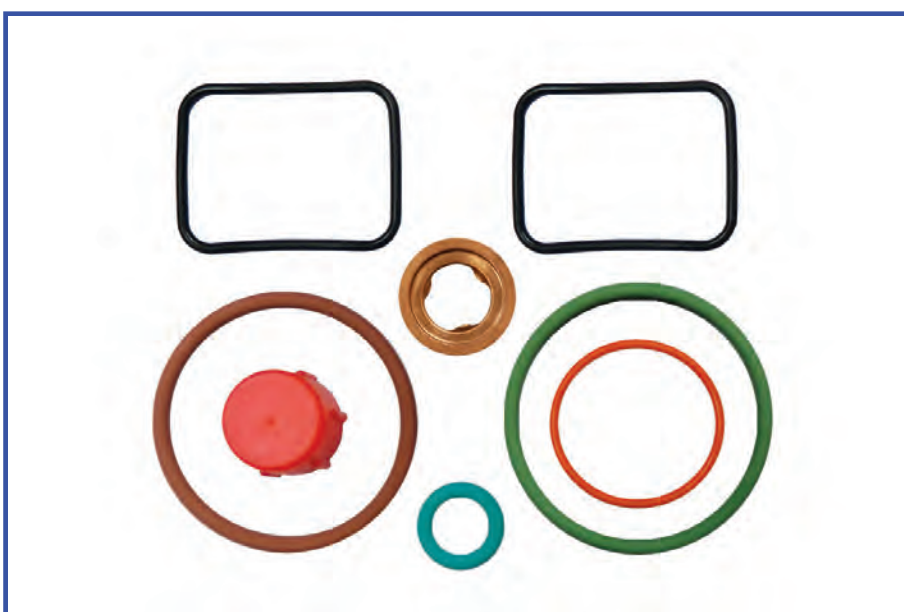

TIPO-TYPE PLD 1D 110/520

CODICE OMS 11-23-196

KIT VITI MERCEDES
N°30 pezzi



TIPO-TYPE

CODICE OMS 11-23-202

TENUTA ESTERNA
IVECO-SCANIA
Bh F 00V X99 995
IVECO 500379769
SCANIA1440576



TIPO-TYPE PDE 100

CODICE OMS 11-23-203

TENUTA ESTERNA
IVECO
Bh F 00V X99 996
IVECO 500350189



TIPO-TYPE PDE 90

CODICE OMS 11-23-204

ANELLI APPOGGIO
E SPINE ALLINEAMENTO
Bh F 00H N37 927

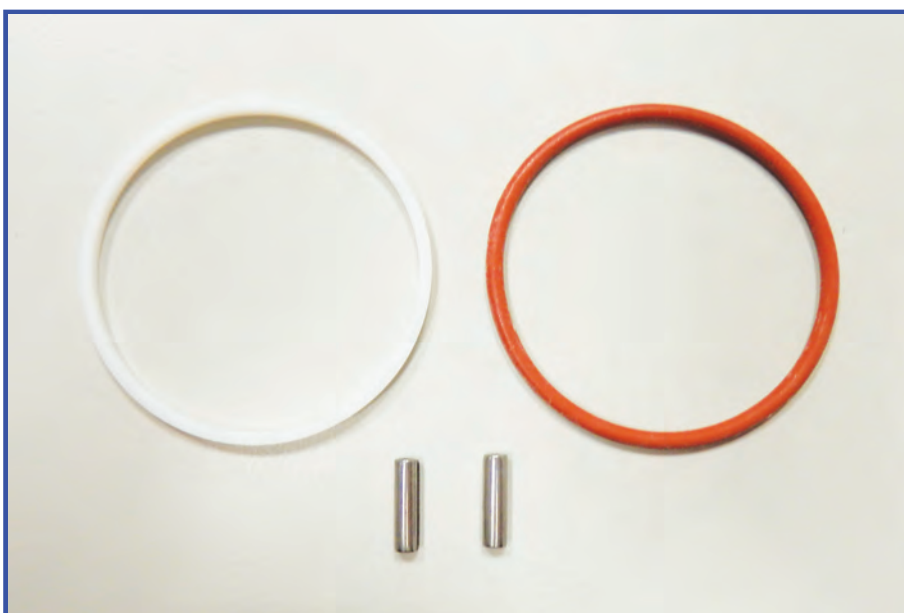

TIPO-TYPE PDE 100



11-23-***

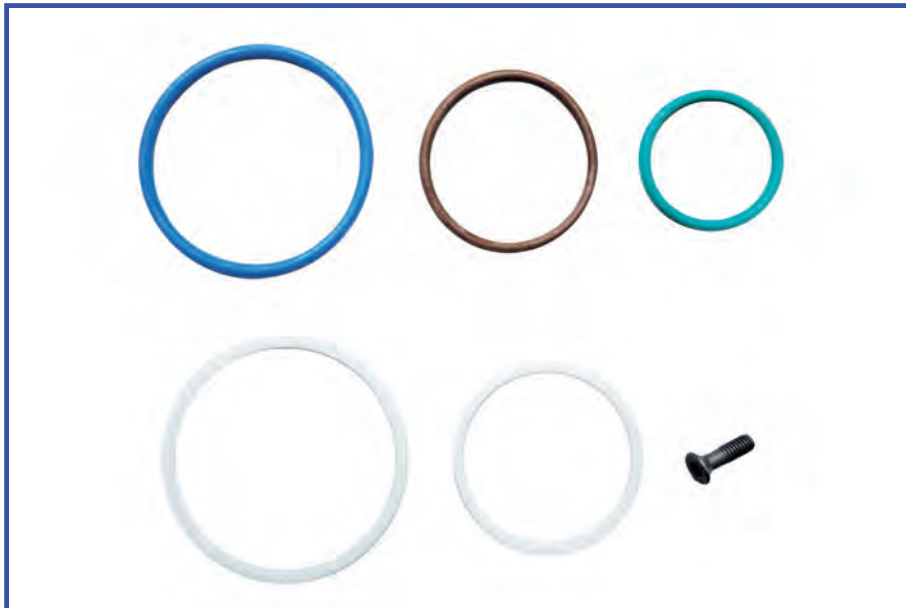

CODICE OMS 11-23-205

Bh F 00H N37 928
SCANIA 1731209

TIPO-TYPE PDE 90/100



CODICE OMS 11-23-205/1

N°5 KIT PER BUSTA
Bh F 00H N37 928
SCANIA 1731209

TIPO-TYPE PDE 90/100

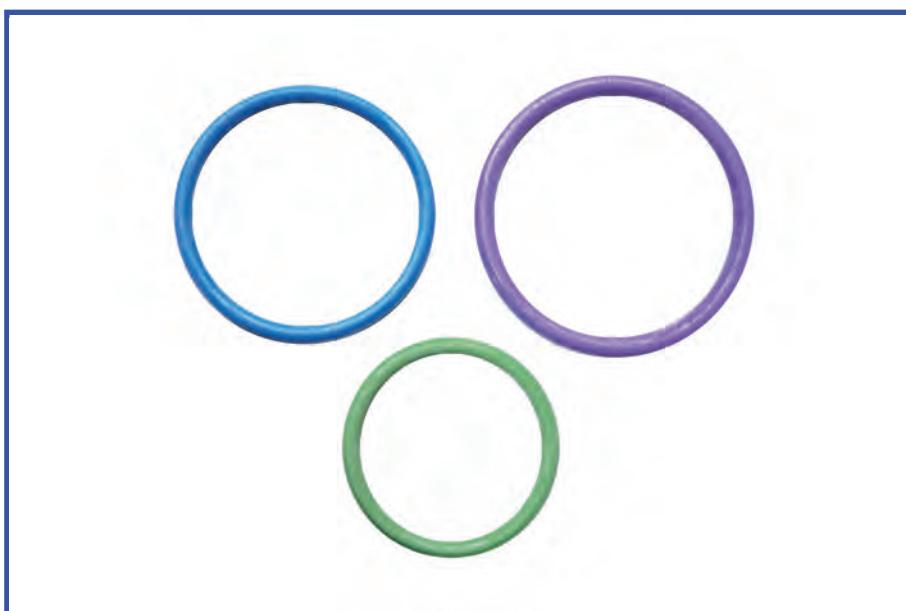

CODICE OMS 11-23-206

TENUTA ESTERNA SCANIA

Bh F 00V X99 999
SCANIA 1398810
SCANIA 1422564

TIPO-TYPE PDE 100

CODICE OMS 11-23-210

Bh F 00H N37 926
 Bh F 00H N37 927
 Bh F 00V X99 999



TIPO-TYPE PDE 90/100

CODICE OMS 11-23-212

KIT RONDELLA TENUTA E
 LAMIERINO

Bh F 00V C99 002
 Bh F 00R J02 176



TIPO-TYPE

CODICE OMS 11-23-213

TENUTA ESTERNA E
 SOLENOIDE

SCANIA - VOLVO - IVECO
 CURSOR 8

Rif.or. F 00H N37 928
 Rif.or. F 00V X99 996

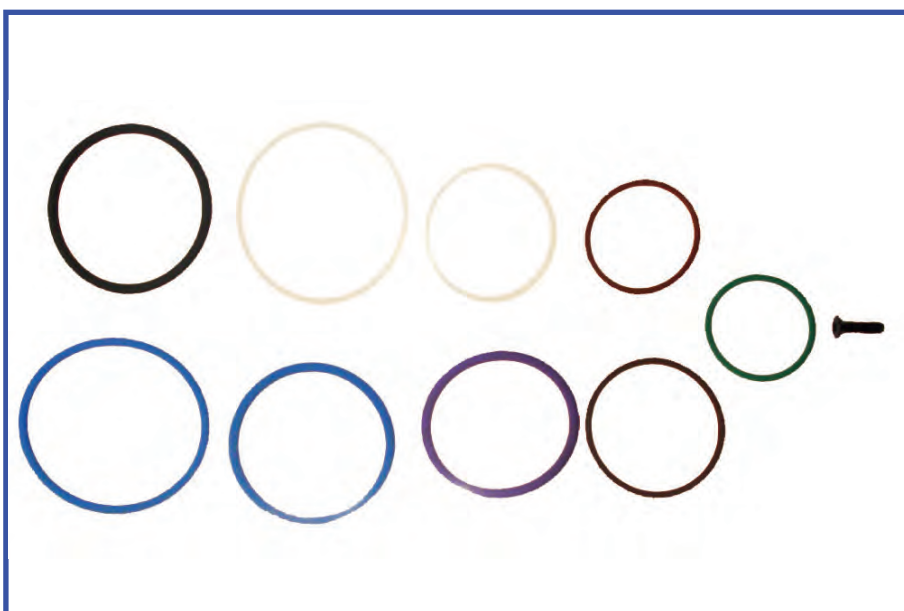

TIPO-TYPE PDE 90



CODICE OMS 11-23-214

KIT INIETTORE
COMMON-RAIL

Rif.or. F 00V C05 001

Rif.or. F 00V C17 002

Rif.or. F 00V C17 105

Rif.or. F 00V C04 049

Rif.or. F 00R J00 222

TIPO-TYPE



CODICE OMS 11-23-214/1

KIT INIETTORE
COMMON-RAIL
Con 2 Oring in NBR

TIPO-TYPE



CODICE OMS 11-23-216

KIT INIETTORE
COMMON-RAIL
RENAULT 420 Dci

Rif.or. F 00V C05 001

Rif.or. F 00V C17 002

Rif.or. F 00R J00 220

Rif.or. 2 460 210 249

Rif.or. F 00V C04 049

Rif.or. F 00V C17 105

TIPO-TYPE

CODICE OMS 11-23-217

TENUTA ESTERNA E
SOLENOIDE

CURSOR 8 - 10 - 13
UNIVERSALE

Rif.or. F 00V X99 998

Rif.or. F 00H N37 928

Rif.or. F 00V X99 996

Rif. Volvo 276948

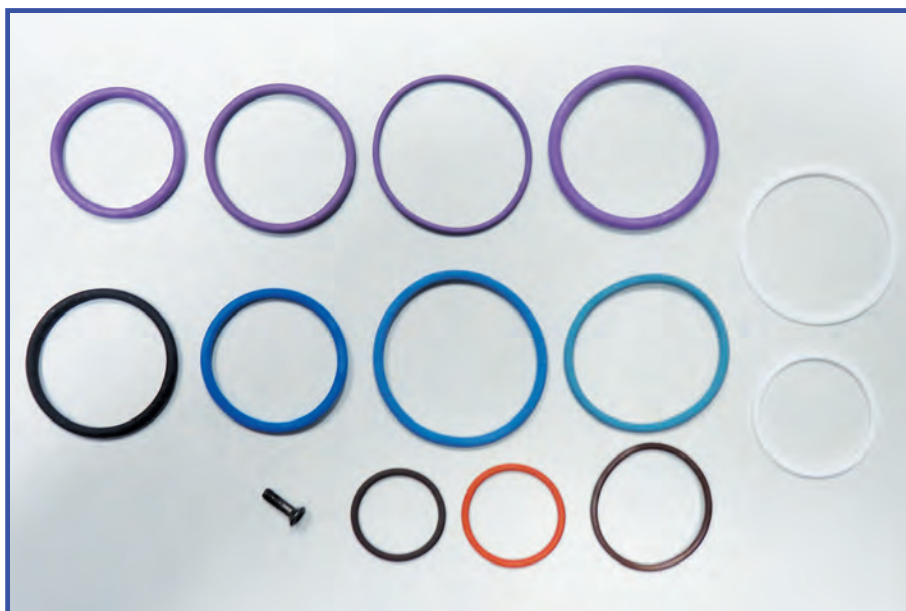

TIPO-TYPE

CODICE OMS 11-23-218

KIT COMPRESSIONE

COD. Bh F 00H N37 926



TIPO-TYPE PDE 90/100

CODICE OMS 11-23-221

KIT SPINE ALLINEAMENTO
Ø 1,5x17 mm
N°100 pezzi per sacchetto



TIPO-TYPE PDE 80



11-23-***

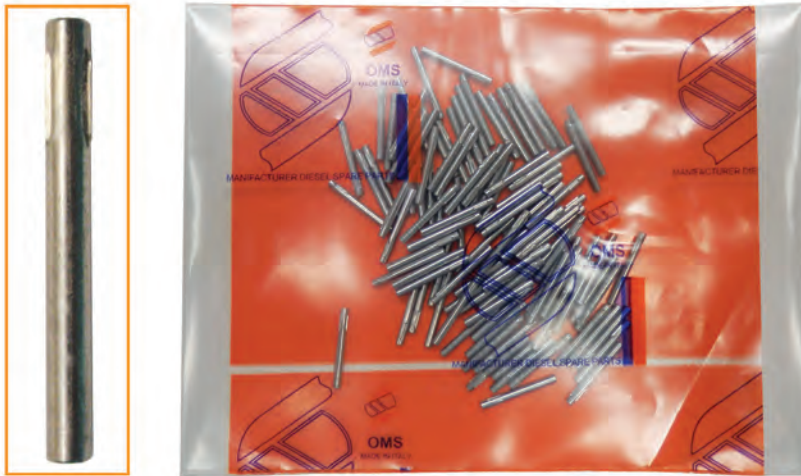

CODICE OMS 11-23-222

KIT SPINE ALLINEAMENTO
Ø 1,8x17 mm
N°100 pezzi per sacchetto

TIPO-TYPE



CODICE OMS 11-23-223

COMMON-RAIL
UNIVERSALE
N°2 paraoli 20x31x7

TIPO-TYPE CP1



CODICE OMS 11-23-225

KIT VOLKSWAGEN
Bh 1 417 010 996
VW 03G 198 051

TIPO-TYPE PDE-P2/80



CODICE OMS 11-23-239

KIT INIETTORE
COMMON-RAIL

Rif.or. F 00V C05 002
 Rif.or. F 00V C05 008
 Rif.or. F 00V C17 002
 Rif.or. F 00V C17 105
 Rif.or. F 00V C04 049
 Rif.or. F 00R J00 222



TIPO-TYPE

CODICE OMS 11-23-241

COMMON-RAIL
UNIVERSALE

N°4 paraoli:
 10x18,8x5,2
 20x31x7
 25x36x7
 25x37x7



TIPO-TYPE CP3

CODICE OMS 11-23-246

KIT PORTAINIETTORI
Caterpillar 10027

TIPO-TYPE

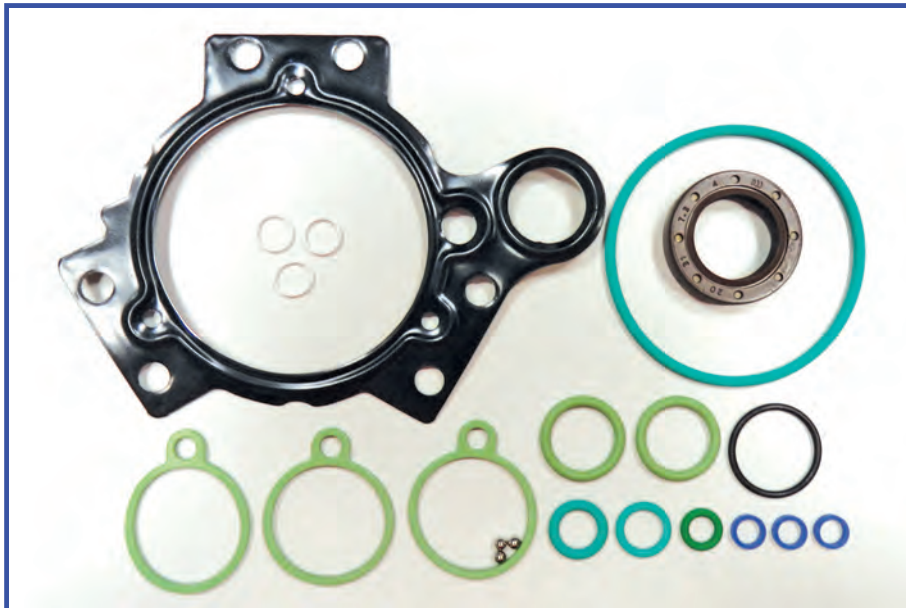

CODICE OMS 11-23-247

GASKET KIT
POMPA SIEMENS
Con paraolio 20x31x7

TIPO-TYPE



CODICE OMS 11-23-248

COD.

GASKET KIT
F 00N 201 973

TIPO-TYPE CP3



CODICE OMS 11-23-248/1

COD.

GASKET KIT
F 00N 201 973/1

TIPO-TYPE CP3



CODICE OMS 11-23-249

GASKET KIT
 COD. F 00N 201 974

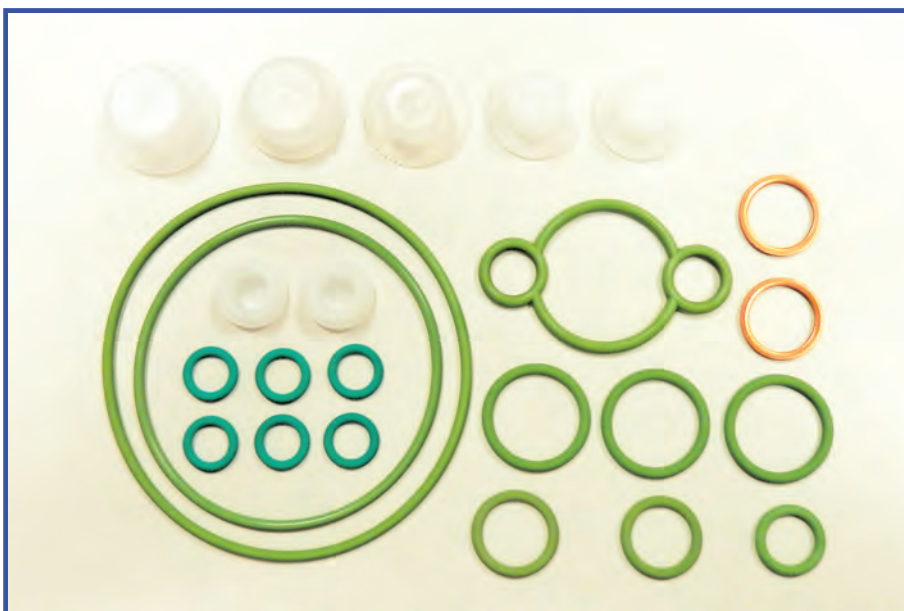

TIPO-TYPE CP3

CODICE OMS 11-23-250

GASKET KIT
 COD. F 00N 201 975

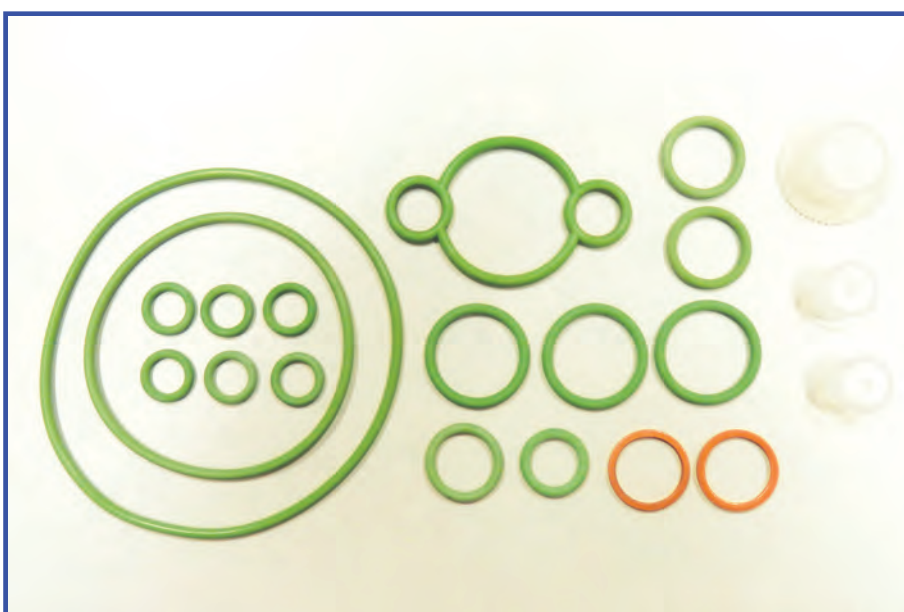

TIPO-TYPE CP3

CODICE OMS 11-23-251

GASKET KIT
 COD. F 00N 201 976



TIPO-TYPE CP3

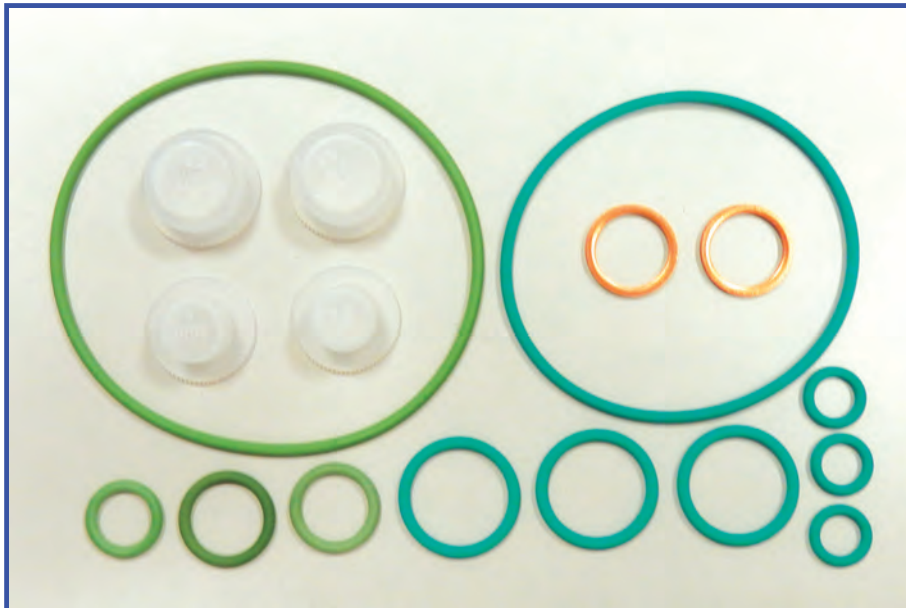

CODICE OMS 11-23-252

GASKET KIT
COD. F 00N 201 977

TIPO-TYPE CP3

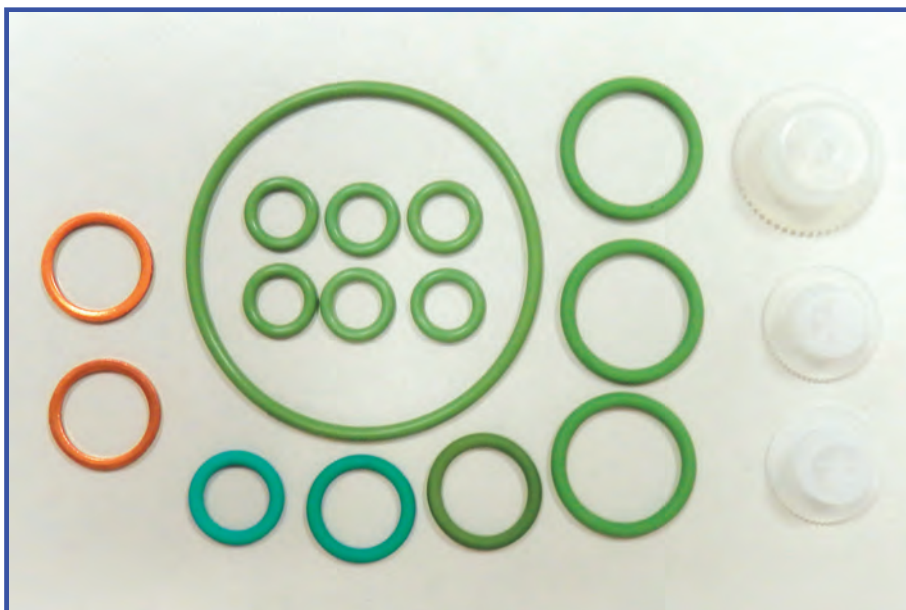

CODICE OMS 11-23-253

GASKET KIT
COD. F 00N 201 978

TIPO-TYPE CP3



CODICE OMS 11-23-254

GASKET KIT
COD. F 00N 201 979

TIPO-TYPE CP3



CODICE OMS 11-23-259

APPLICAZIONE
VOLKSWAGEN

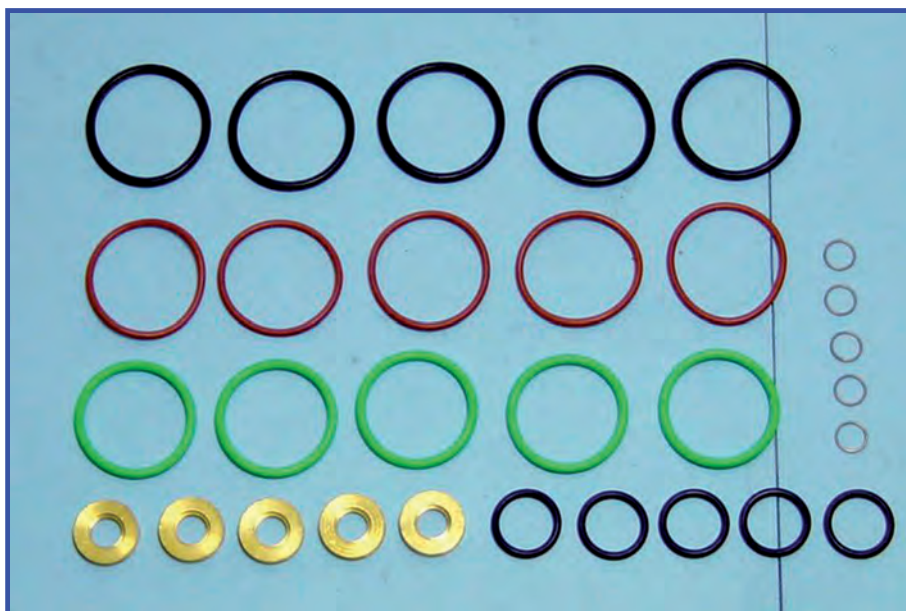

TIPO-TYPE

CODICE OMS 11-23-260

KIT PER MERCEDES
A 008 997 61 45
N°25 o-ring

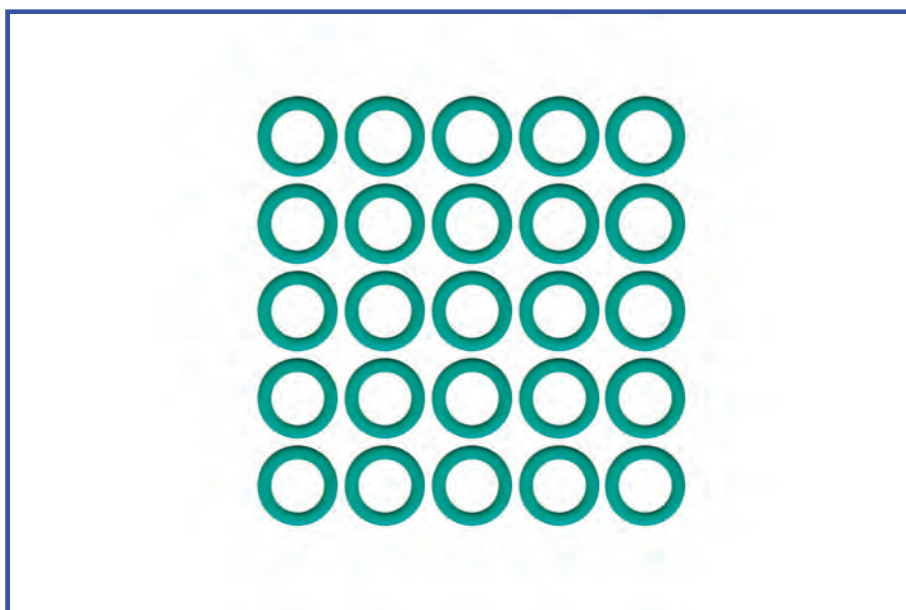

TIPO-TYPE

CODICE OMS 11-23-261

CITARO BUS
kit per 0 432 191 395



TIPO-TYPE



11-23-***

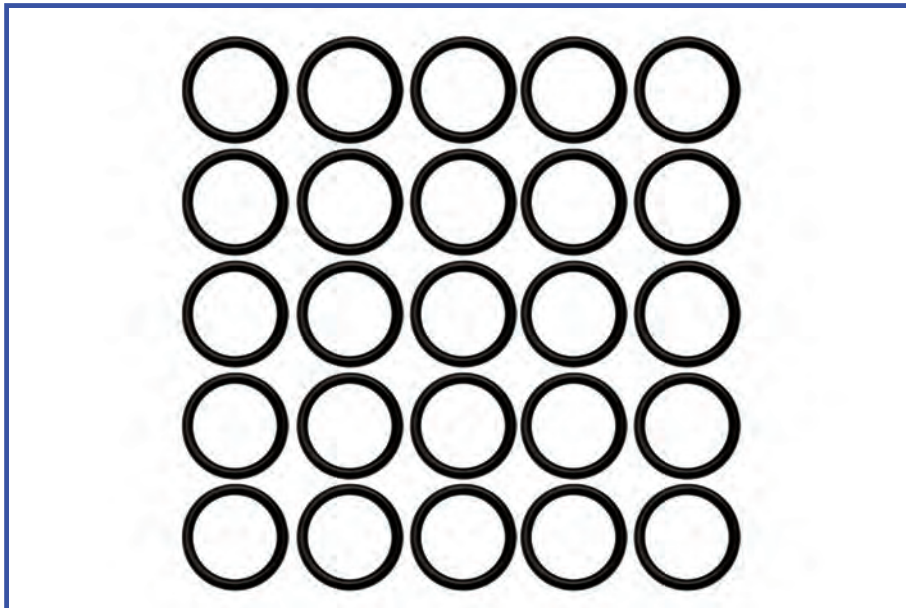

CODICE OMS 11-23-265

MERCEDES A 541 997 05 45
N°25 o-ring
Misura 21x3 in viton

TIPO-TYPE DAF-ATEGO-TECTOR



CODICE OMS 11-23-280

KIT POMPA SIEMENS
N°2 paraoli:
20x31x7
20x32x7

TIPO-TYPE



CODICE OMS 11-23-281

KIT UNIVERSALE
POMPA SIEMENS
N°2 paraoli:
20x31x7
20x32x7

TIPO-TYPE

CODICE OMS 11-23-282

Rif.or. F 00V X99 998
VOLVO 1677158
DTC 5235710

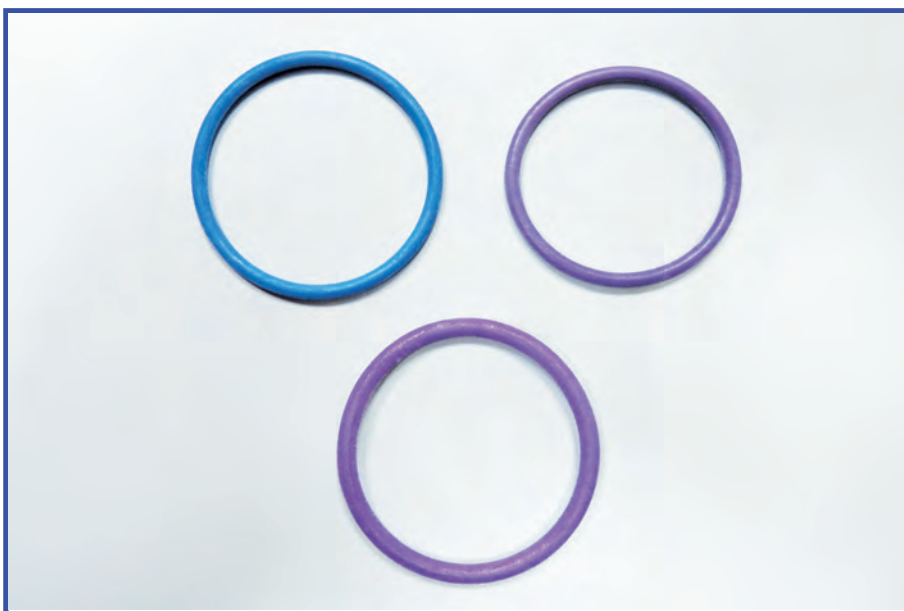

TIPO-TYPE PDE 100

CODICE OMS 11-23-284

KIT INIETTORE
COMMON-RAIL
Con sfera in ceramica Ø 1,50
per iniettore
PIEZOELETRICO



TIPO-TYPE

CODICE OMS 11-23-289

KIT RECUPERO 4 CILINDRI
1 mt tubo telato esterno
per gasolio 3x7

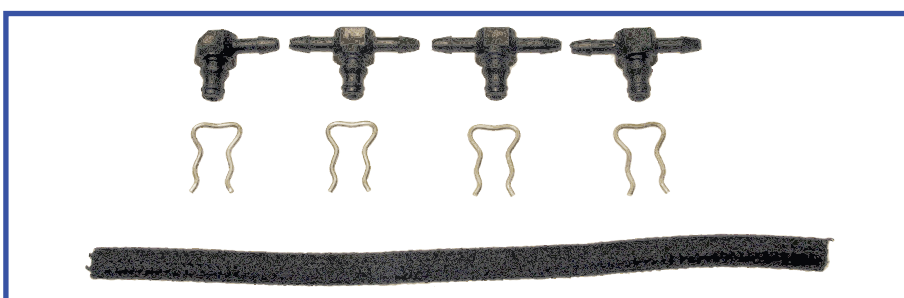

CODICE OMS 11-23-289/1

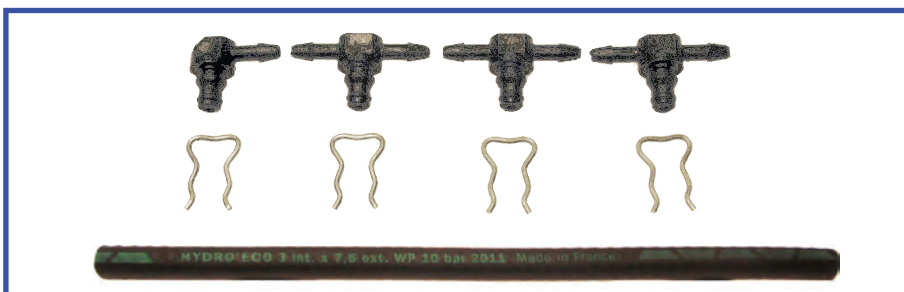
KIT RECUPERO 4 CILINDRI
1 mt tubo telato interno
per benzina e gasolio 3x7

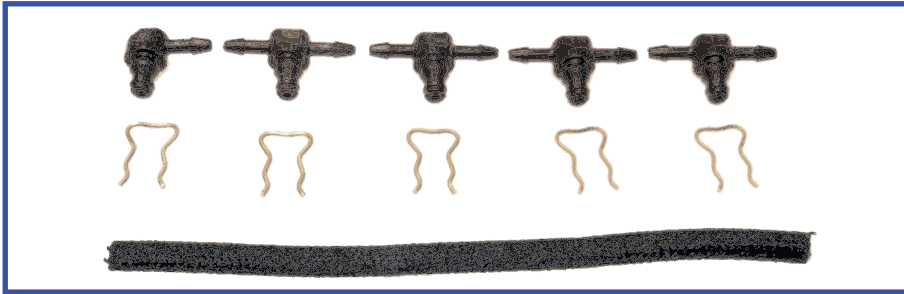

**CODICE OMS 11-23-290**

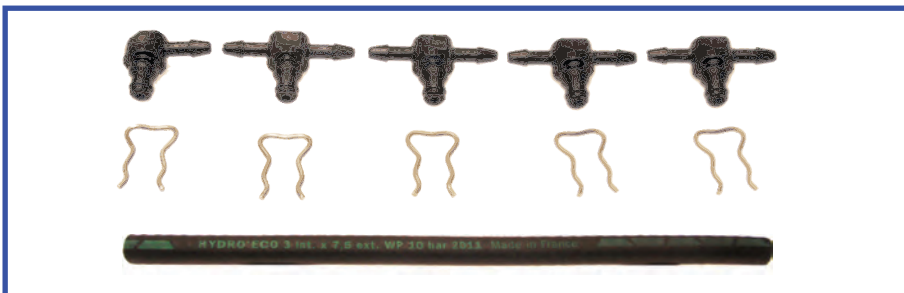
KIT RECUPERO 5 CILINDRI

1 mt tubo telato esterno
per gasolio 3x7**CODICE OMS 11-23-290/1**

KIT RECUPERO 5 CILINDRI

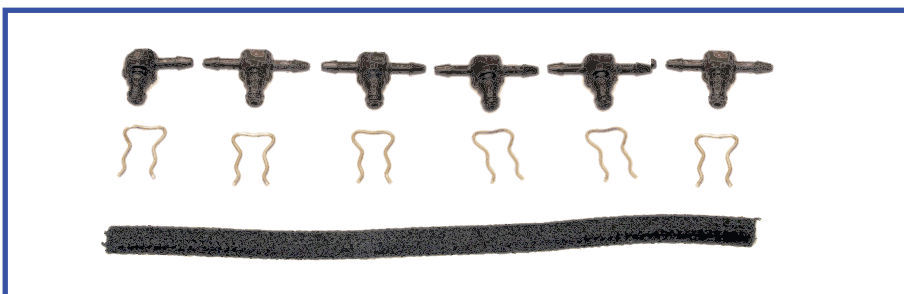
1 mt tubo telato interno
per benzina e gasolio 3x7**CODICE OMS 11-23-291**

KIT RECUPERO 6 CILINDRI

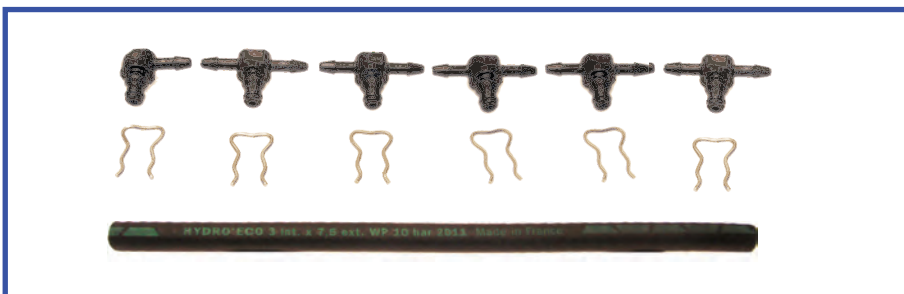
1 mt tubo telato esterno
per gasolio 3x7**CODICE OMS 11-23-291/1**

KIT RECUPERO 6 CILINDRI

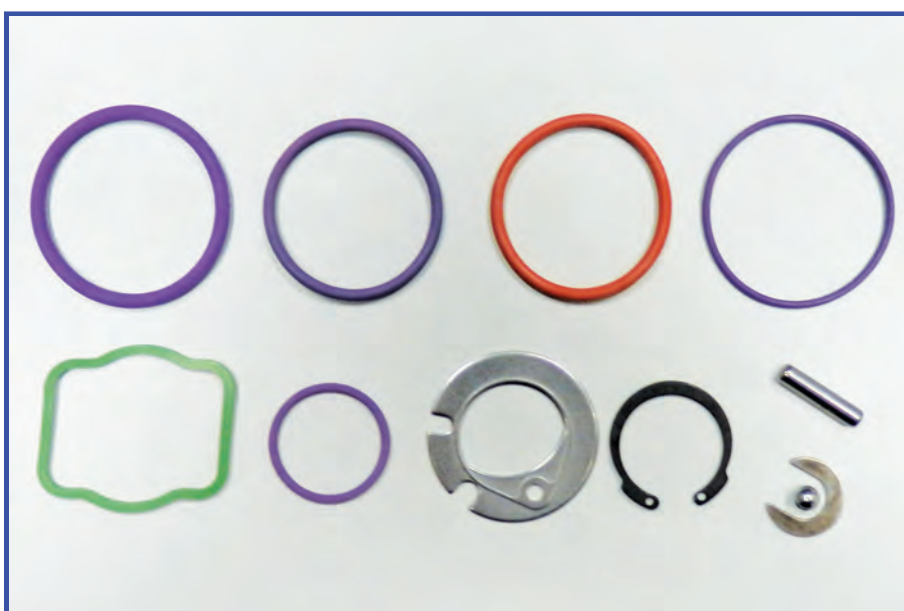
1 mt tubo telato interno
per benzina e gasolio 3x7**CODICE OMS 11-23-294**KIT PER POMPA
INIETTORE VOLVO

COD. Lucas 7135-488

COD. kit EUI Volvo 1547909

TIPO-TYPE DELPHI



CODICE OMS 11-23-294/1

KIT PER POMPA
INIETTORE VOLVO
Senza medaglietta

COD. Lucas 7135-488

COD. kit EUI VOLVO 1547909



TIPO-TYPE DELPHI

CODICE OMS 11-23-302

KIT SPINE ALLINEAMENTO
Ø 1,4x24 mm
N°100 pezzi per sacchetto



TIPO-TYPE

CODICE OMS 11-23-303

KIT UNIVERSALE PER CP1
F 01M 100 275
F 01M 100 276
F 01M 100 277



TIPO-TYPE CP1



11-23-***

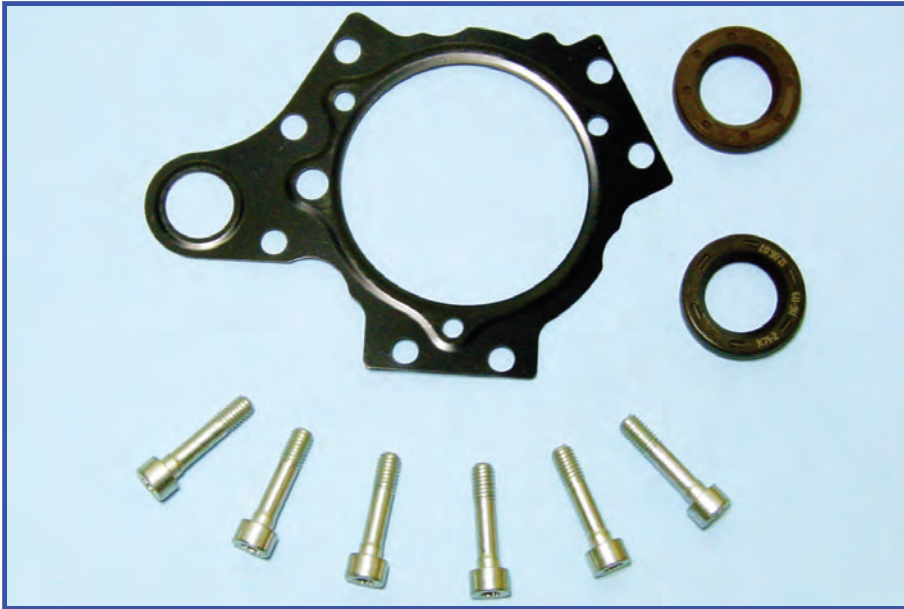

CODICE OMS 11-23-316

GASKET KIT
POMPE SIEMENS

COD. X39-800-300-019Z

COD. X39-800-300-020Z

TIPO-TYPE DW10 BTED - DV4 TD



CODICE OMS 11-23-317

GASKET KIT
POMPE SIEMENS

COD. X39-800-300-001Z

TIPO-TYPE DW10 TD



CODICE OMS 11-23-318

GASKET KIT
POMPE SIEMENS

COD. X39-800-300-015Z

TIPO-TYPE DV4 TD



CODICE OMS 11-23-319

GASKET KIT
POMPE SIEMENS

COD. X39-800-300-002Z



TIPO-TYPE DW10 TD

CODICE OMS 11-23-320

GASKET KIT
POMPE SIEMENS

COD. X39-800-300-016Z

COD. X39-800-300-017Z

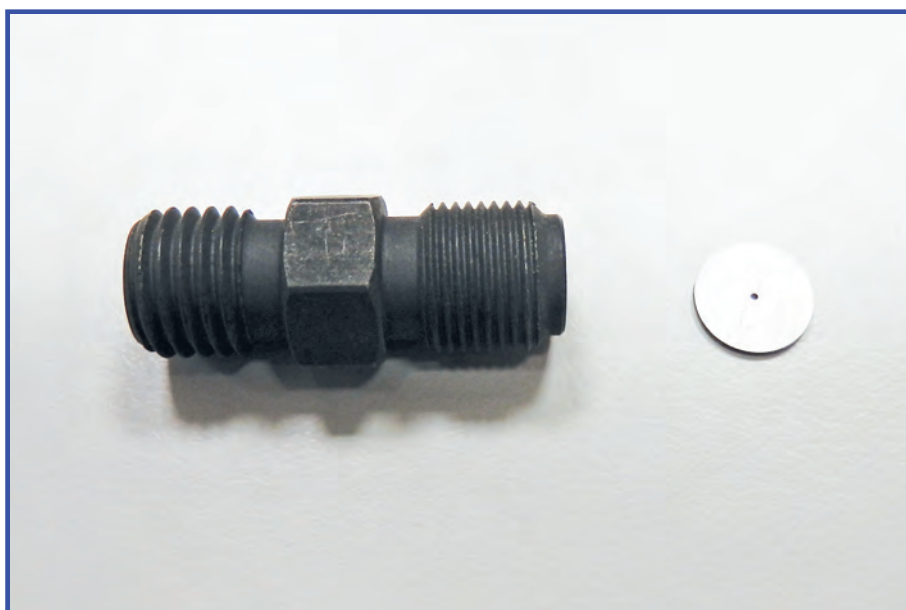

TIPO-TYPE DW10 BTED

CODICE OMS 11-23-321

GASKET KIT
POMPE SIEMENS

COD. X39-800-300-003Z

COD. X39-800-300-012Z

COD. X39-800-300-013Z



TIPO-TYPE DW10 TD - DV4TD
DW10 BTED



11-23-***

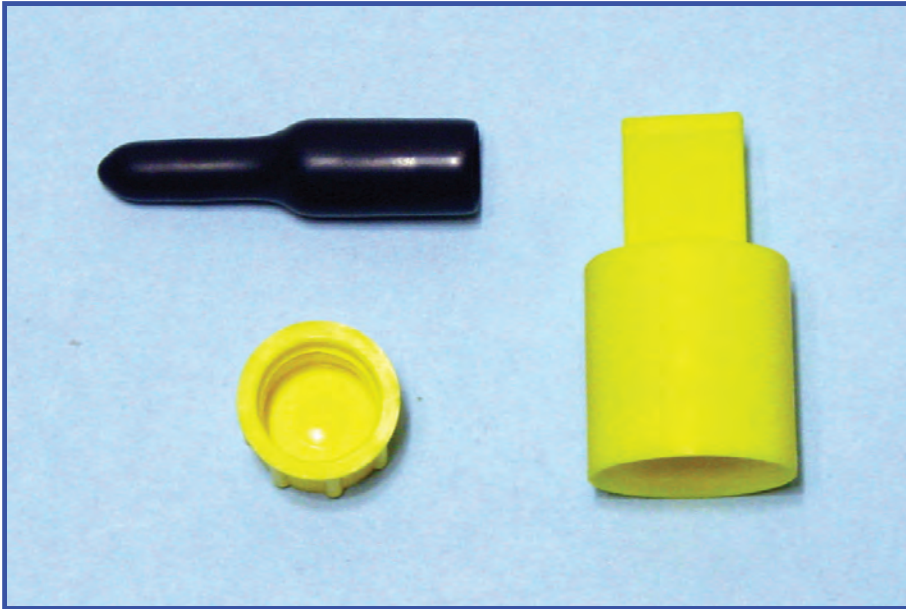

CODICE OMS 11-23-322

GASKET KIT
POMPE SIEMENS

COD. X39-800-300-014Z

TIPO-TYPE DW10 BTED VOLVO

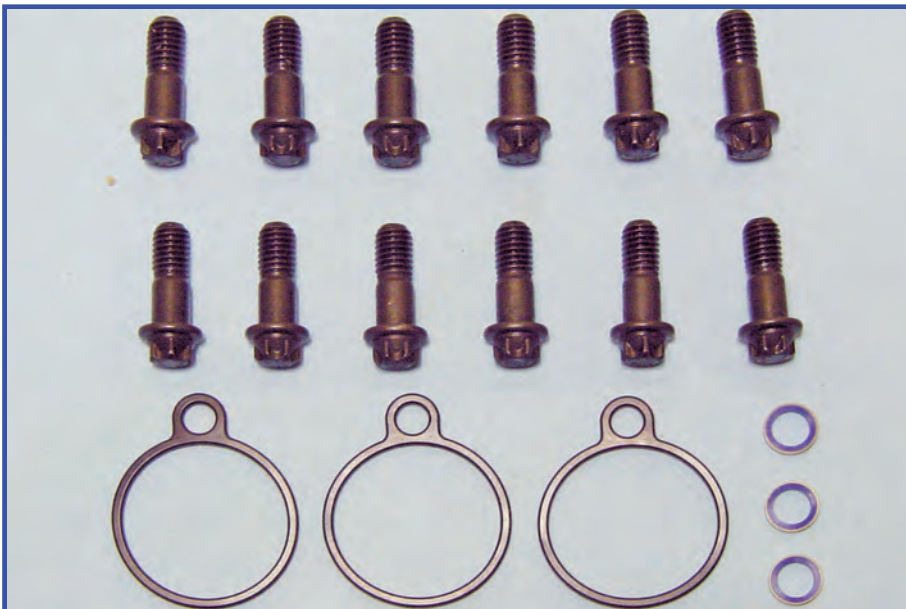

CODICE OMS 11-23-323

GASKET KIT
POMPE SIEMENS

COD. X39-800-300-004Z

TIPO-TYPE



CODICE OMS 11-23-331

GASKET KIT

TIPO-TYPE CP1H3



CODICE OMS 11-23-346

KIT UNIVERSALE

F 00H N37 928

+

F 00V X99 995

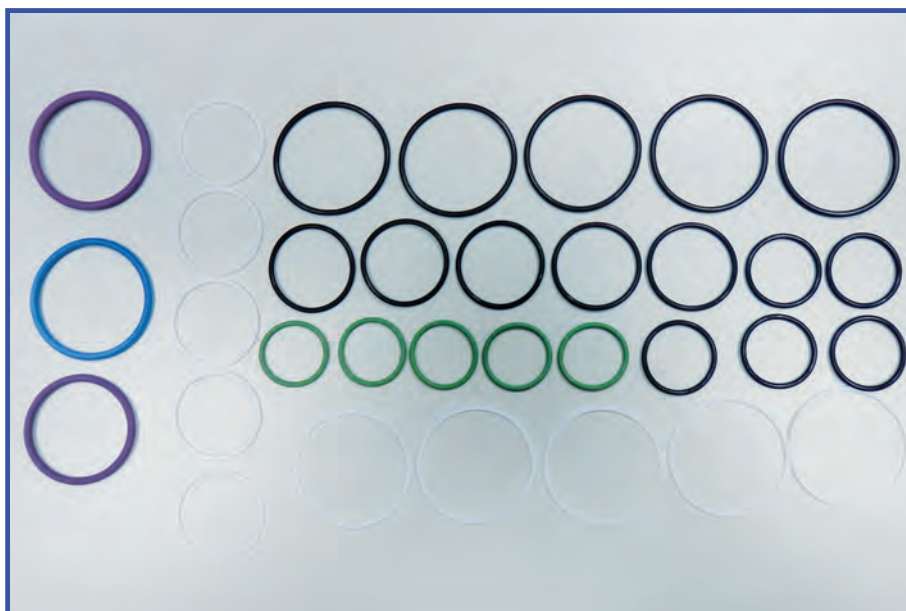

TIPO-TYPE PDE 100

CODICE OMS 11-23-351

GASKET KIT

F 00H N37 759

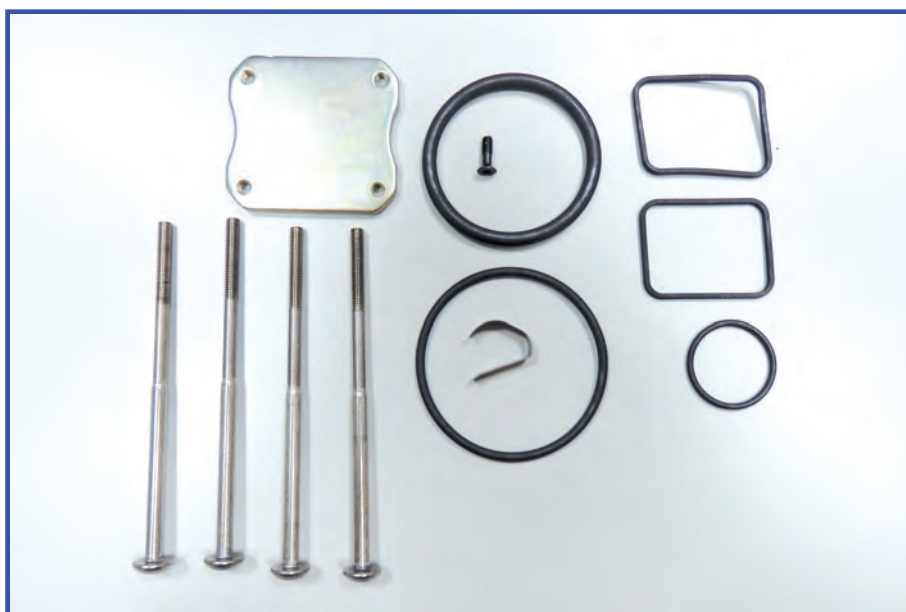

TIPO-TYPE

CODICE OMS 11-23-357

KIT TANDEM

F 009 D00 069

03G 145 209 C

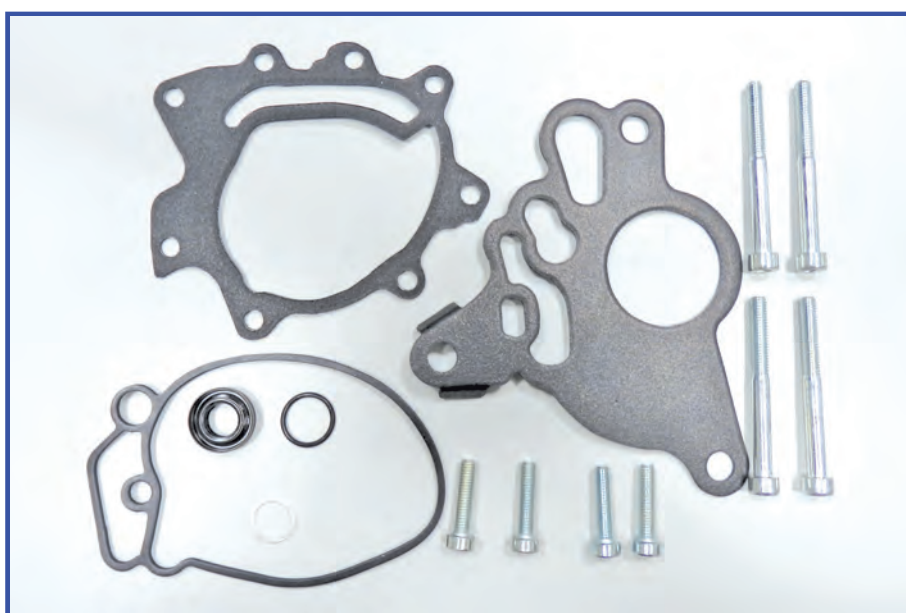

TIPO-TYPE



11-23-***

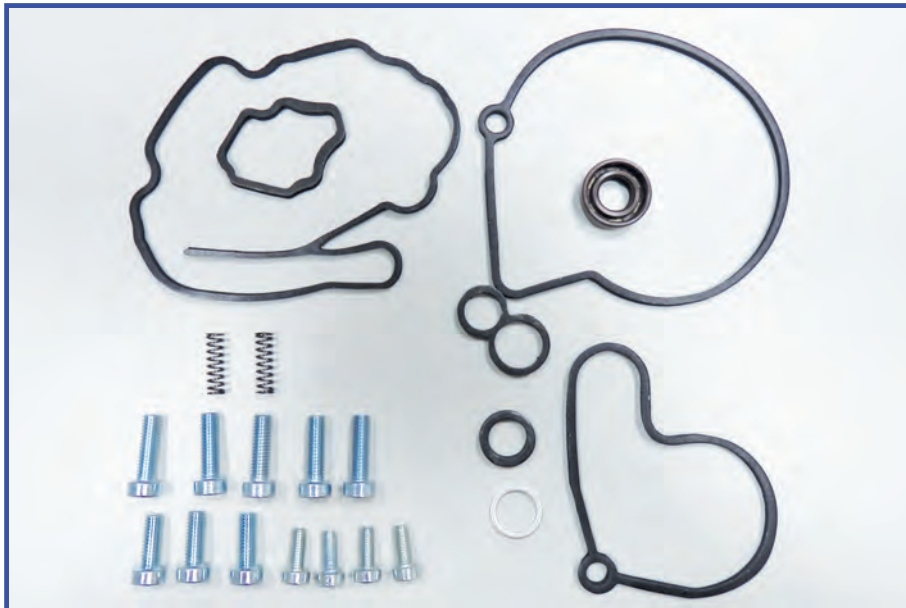

CODICE OMS 11-23-358

KIT TANDEM

F 009 D00 001
038 145 209 A

TIPO-TYPE

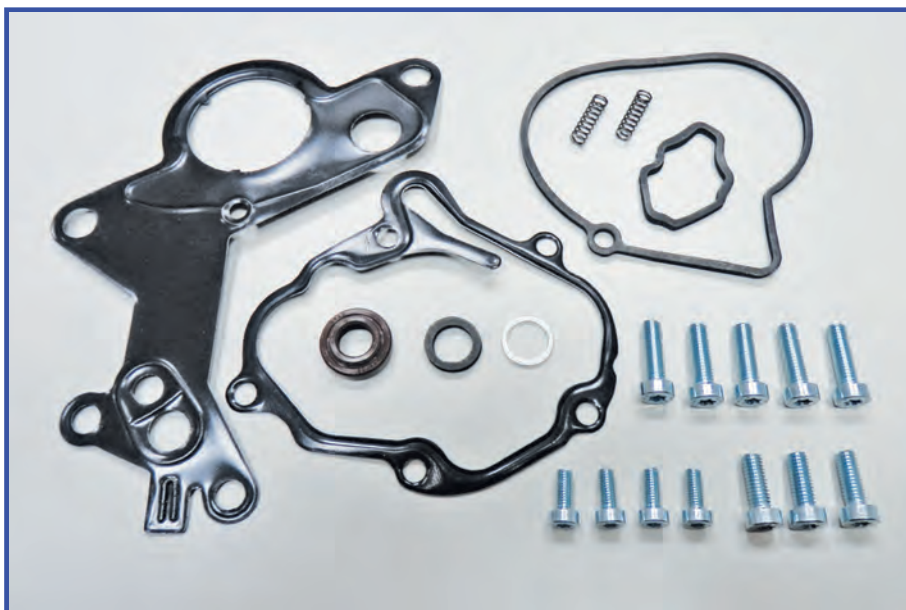

CODICE OMS 11-23-359

KIT TANDEM

038 145 209 E=H=K

Altri KIT TANDEM da pag.203

TIPO-TYPE

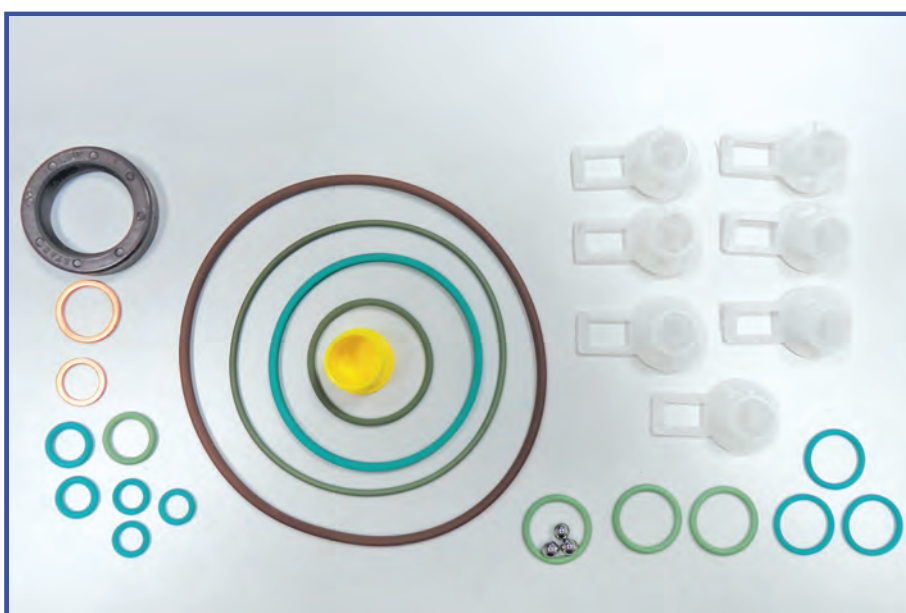

CODICE OMS 11-23-360

MAN

TIPO-TYPE CP3 C/R



CODICE OMS 11-23-361

GASKET KIT
MAN-TGA

TIPO-TYPE ENGINE D28

CODICE OMS 11-23-401

GASKET KIT



TIPO-TYPE

CODICE OMS 11-23-402

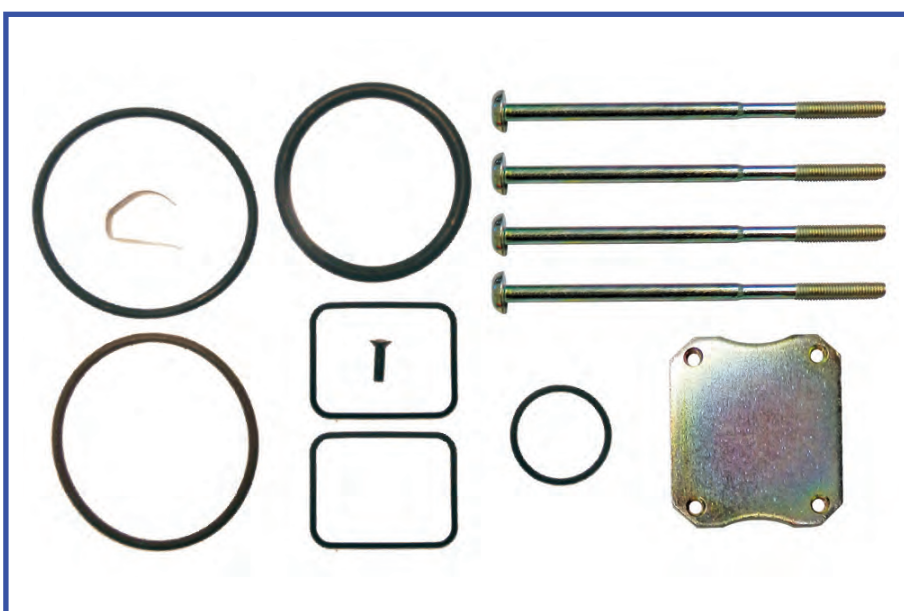
GASKET KIT
F 000 41P 050

TIPO-TYPE PLD1B100/520

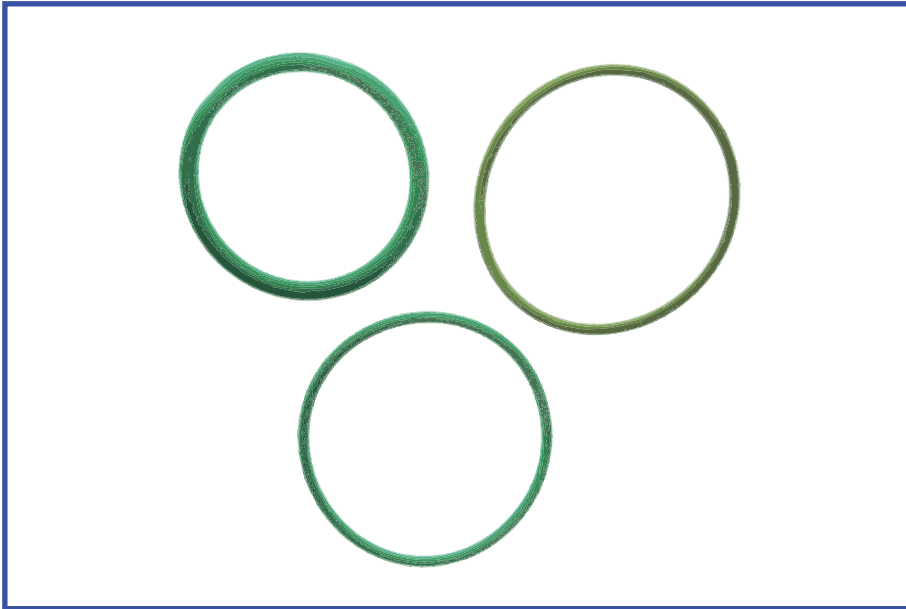

CODICE OMS 11-23-403

F 00V X99 892

TIPO-TYPE PLD1B110/520

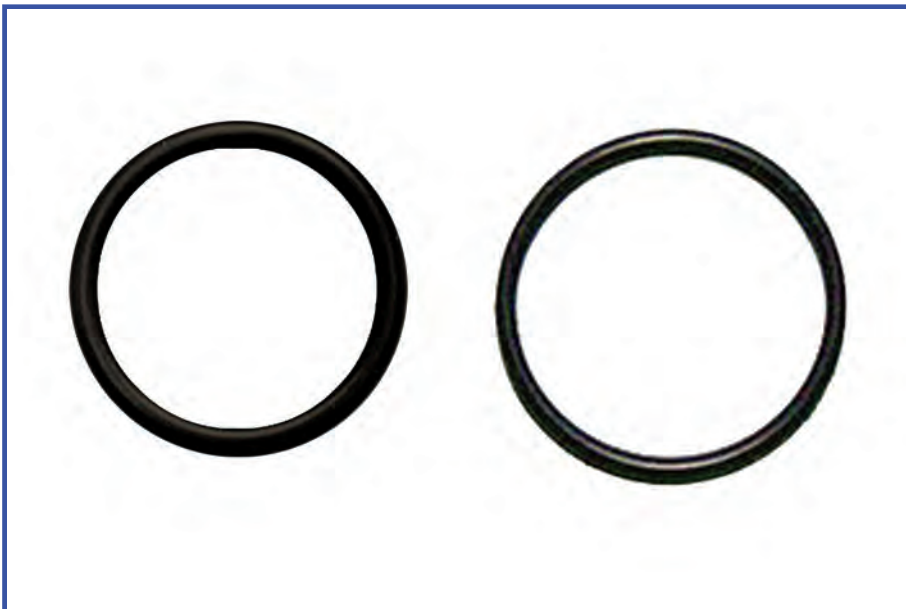

CODICE OMS 11-23-404

GASKET KIT
F 000 41P 049

TIPO-TYPE

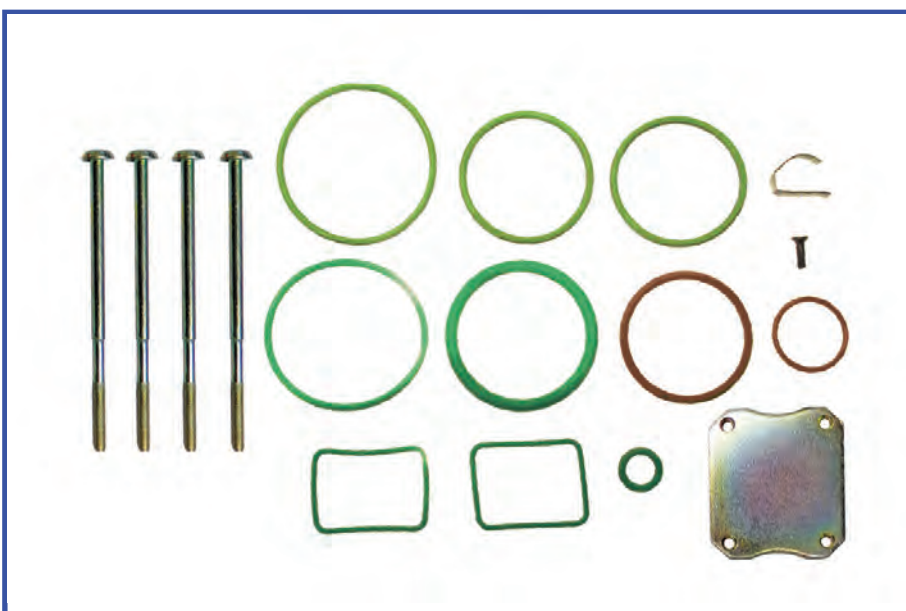

CODICE OMS 11-23-407

UNIVERSALE PLD

TIPO-TYPE PLD



CODICE OMS 11-23-423

COD.

PLD1C100/440
F 00H N37 454

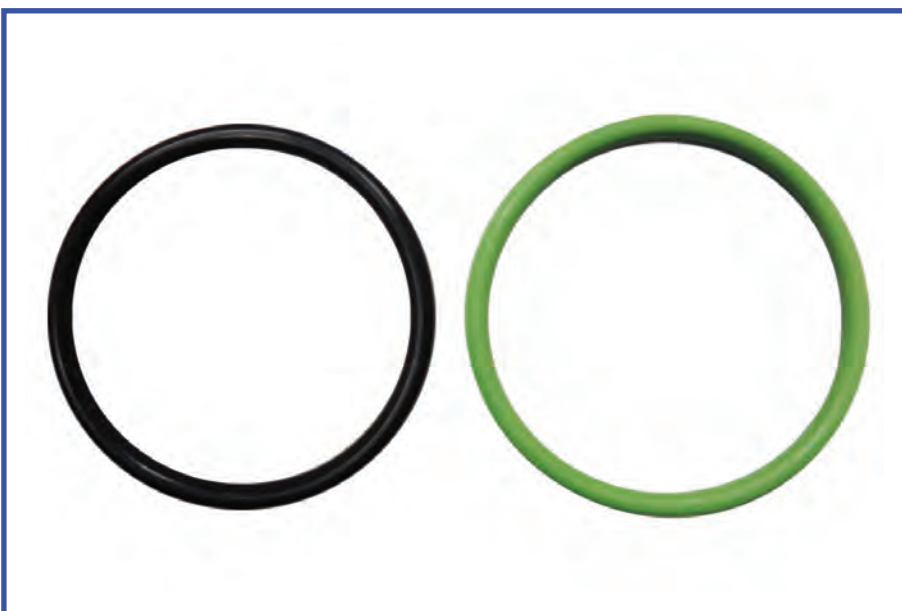

TIPO-TYPE

PLD100/440
24S140-24V200

CODICE OMS 11-23-428

COD.

F 00H 4S0 010



TIPO-TYPE

PDE 100

CODICE OMS 11-23-431

COD.

GASKET KIT
F 00H 4S0 001

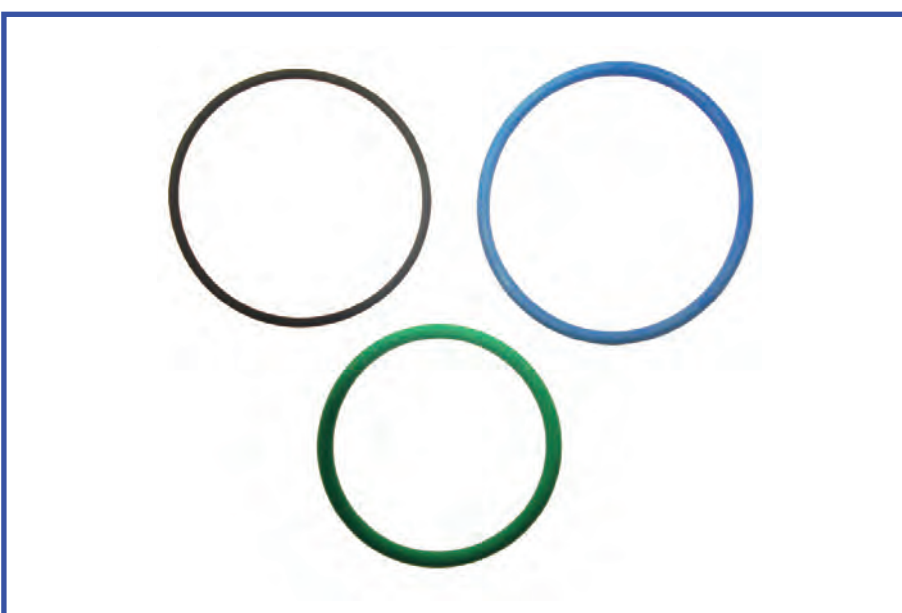

TIPO-TYPE

PDE 100

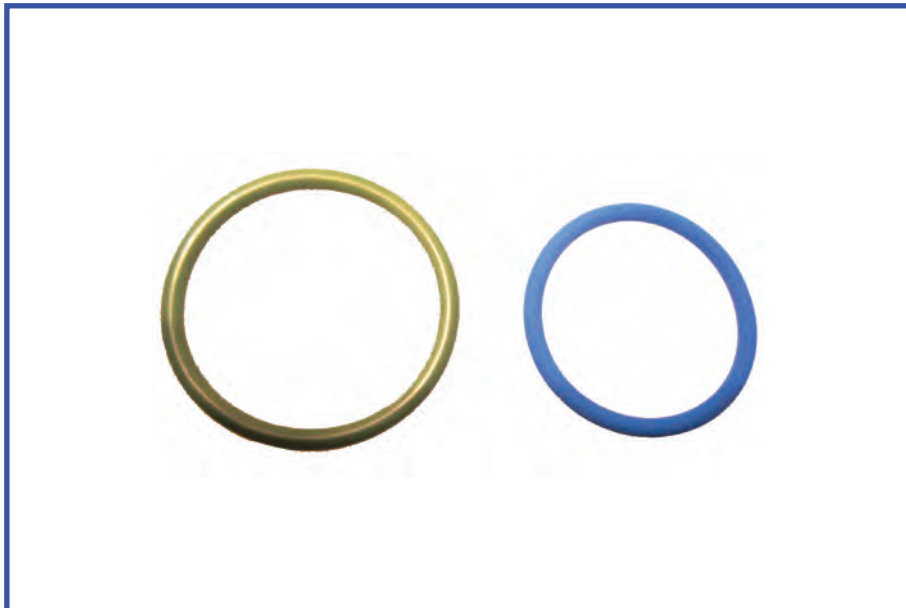

CODICE OMS 11-23-432

COD.

GASKET KIT
F 00H 4S0 002

TIPO-TYPE

PDE 100



CODICE OMS 11-23-433

COD.

KIT MOLLA + ASTINA
F 00H 4S0 008

TIPO-TYPE

PDE 100



CODICE OMS 11-23-446

PLD1A100/440
PLD1A90/440
F 000 41P 053

TIPO-TYPE

PLD



CODICE OMS 11-23-447

PLD1A100/440
 PLD1A90/440
 F 000 41P 052

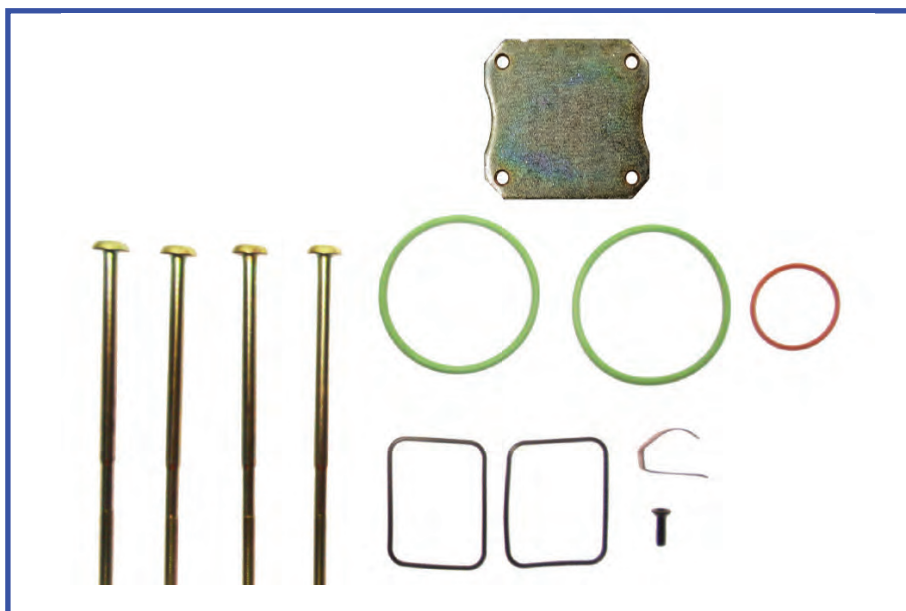

TIPO-TYPE PLD

CODICE OMS 11-23-451

KIT OR DENSO
 14-10-237
 +
 14-10-240



TIPO-TYPE DENSO

CODICE OMS 11-23-458

KIT OR DENSO
 14-10-237
 +
 14-10-239



TIPO-TYPE DENSO



11-23-***



CODICE OMS 11-23-463

KIT DELPHI
7135-287

TIPO-TYPE EUJ

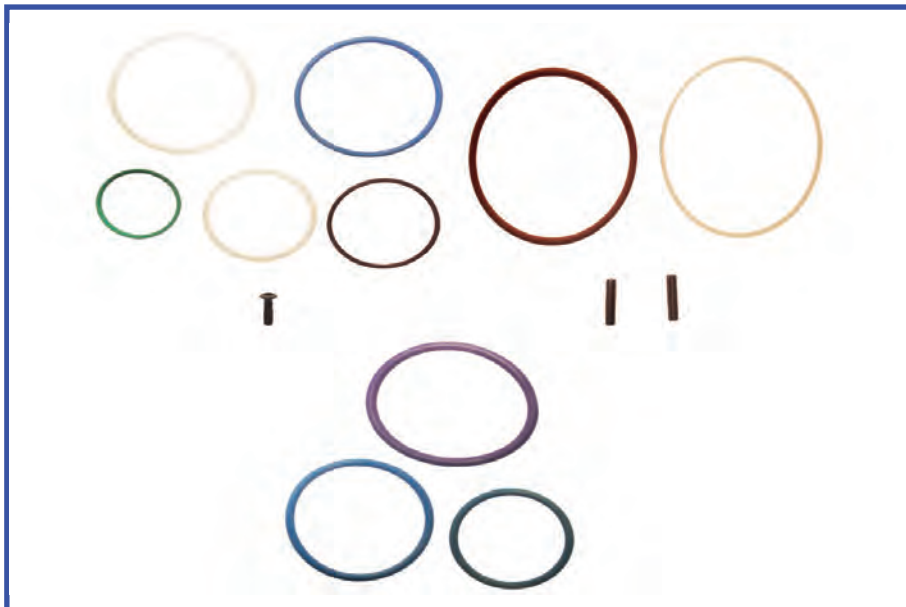

CODICE OMS 11-23-471

GASKET KIT
F 00V X99 999
+
F 00H N37 927
+
F 00H N37 928

TIPO-TYPE PDE 100

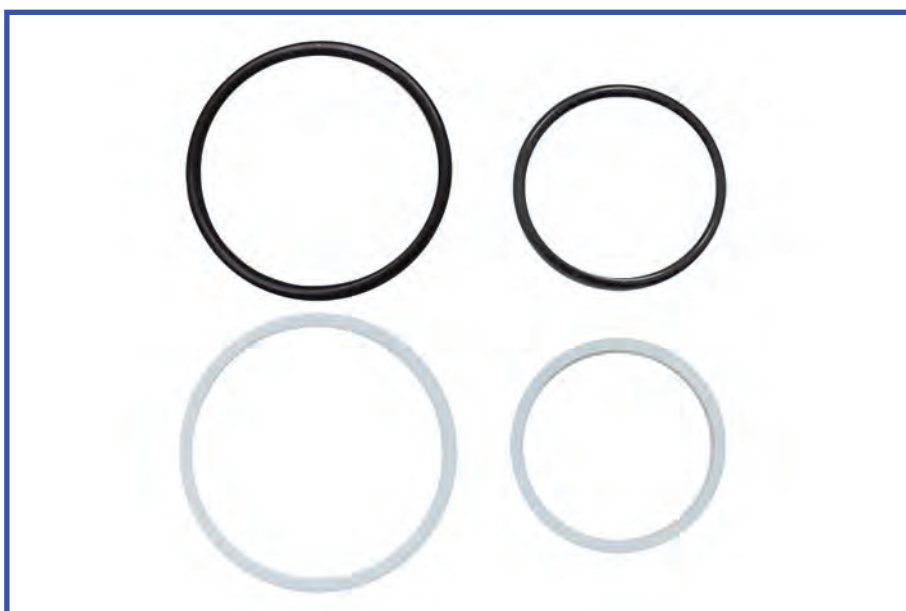

CODICE OMS 11-23-475

F 00H 410 850

TIPO-TYPE PPE100/100/S2***



CODICE OMS 11-23-476

7135-493

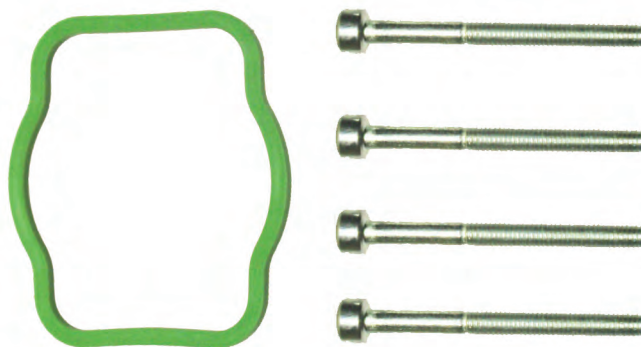

TIPO-TYPE DELPHI

CODICE OMS 11-23-477

331056
8N7005

TIPO-TYPE CATERPILLAR

CODICE OMS 11-23-478

331049
4W7018

TIPO-TYPE CATERPILLAR

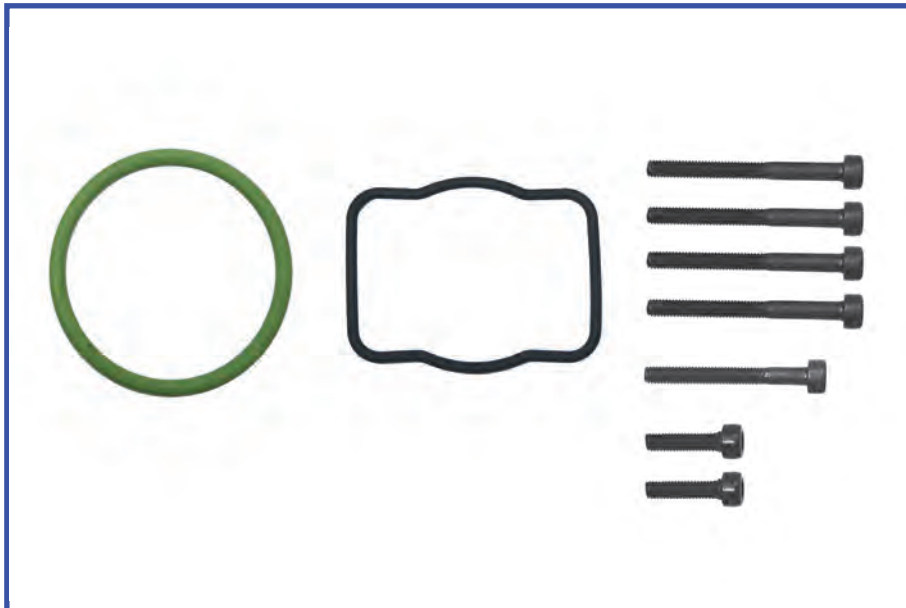

CODICE OMS 11-23-481

KIT INTERNO PER
CATERPILLAR 3406 E

SUITABLE
CATERPILLAR 3406 E

TIPO-TYPE CATERPILLAR

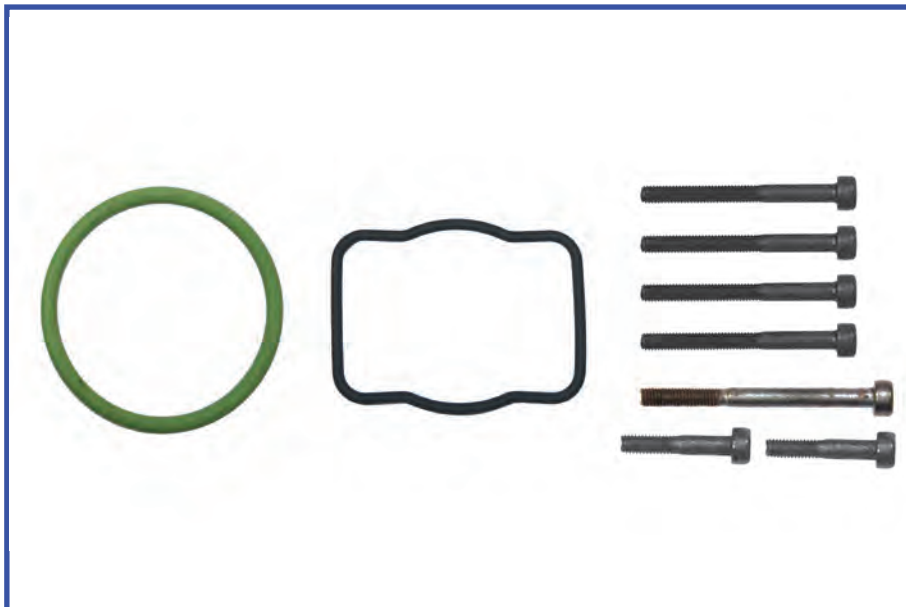

CODICE OMS 11-23-482

KIT INTERNO PER
CATERPILLAR 3406 E

SUITABLE
CATERPILLAR 3406 E

TIPO-TYPE CATERPILLAR

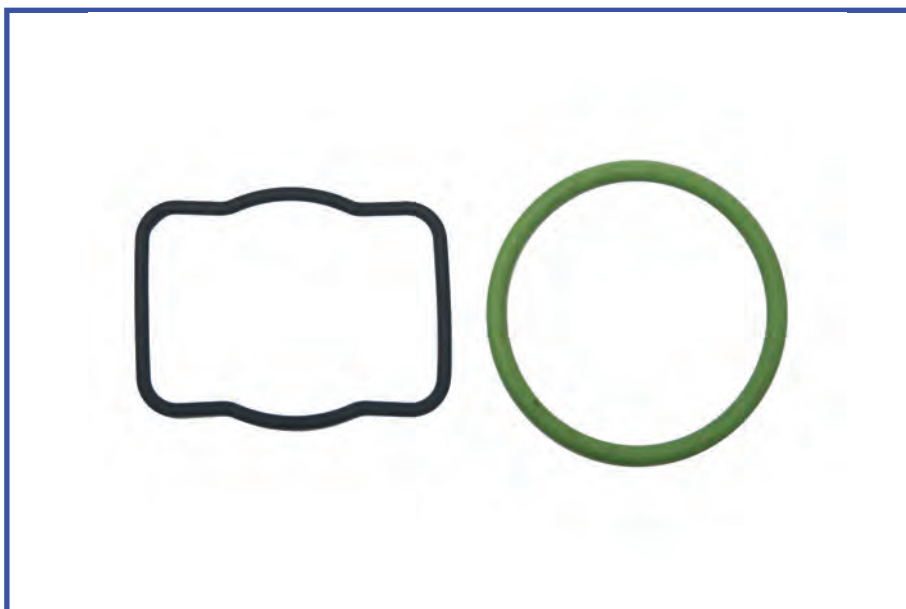

CODICE OMS 11-23-483

KIT INTERNO PER
CATERPILLAR 3406 E

SUITABLE
CATERPILLAR 3406 E

TIPO-TYPE CATERPILLAR



CODICE OMS 11-23-484

KIT ESTERNO PER
CATERPILLAR 3406 E

SITABILE

CATERPILLAR 3406 E

TIPO-TYPE

CATERPILLAR

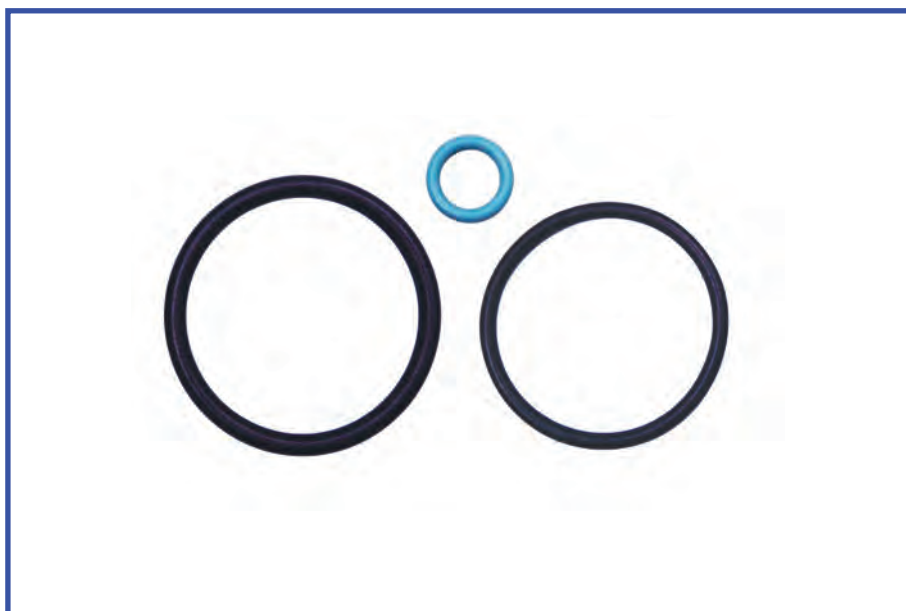

CODICE OMS 11-23-488

KIT INTERNO PER
FORD POWERSTROKE 7.3
Per pistone Ø 16 mm

SITABILE

POWERSTROKE 7.3

TIPO-TYPE

NAVISTAR



CODICE OMS 11-23-489

KIT INTERNO PER
FORD POWERSTROKE 7.3
Per pistone Ø 17,5 mm

SITABILE

POWERSTROKE 7.3

TIPO-TYPE

NAVISTAR

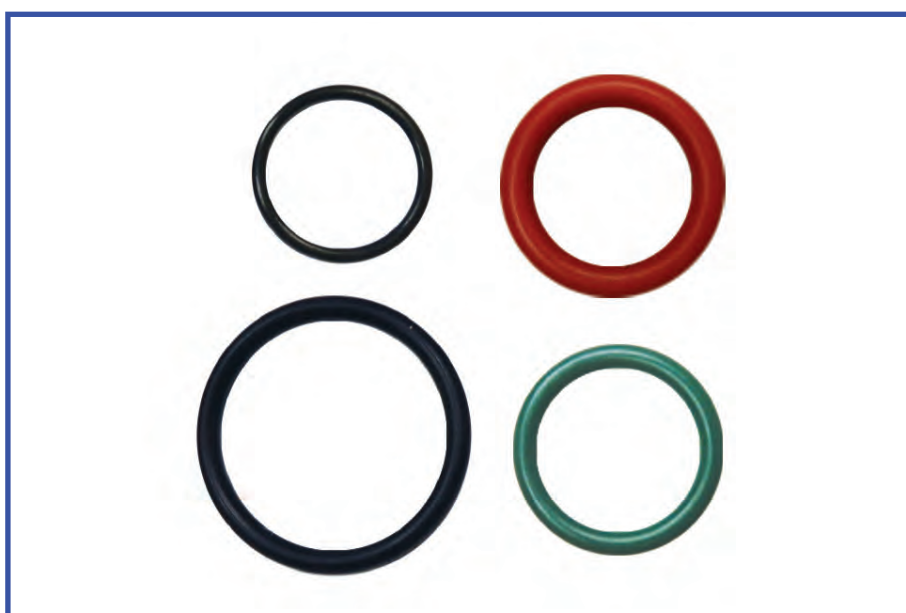



11-23-***

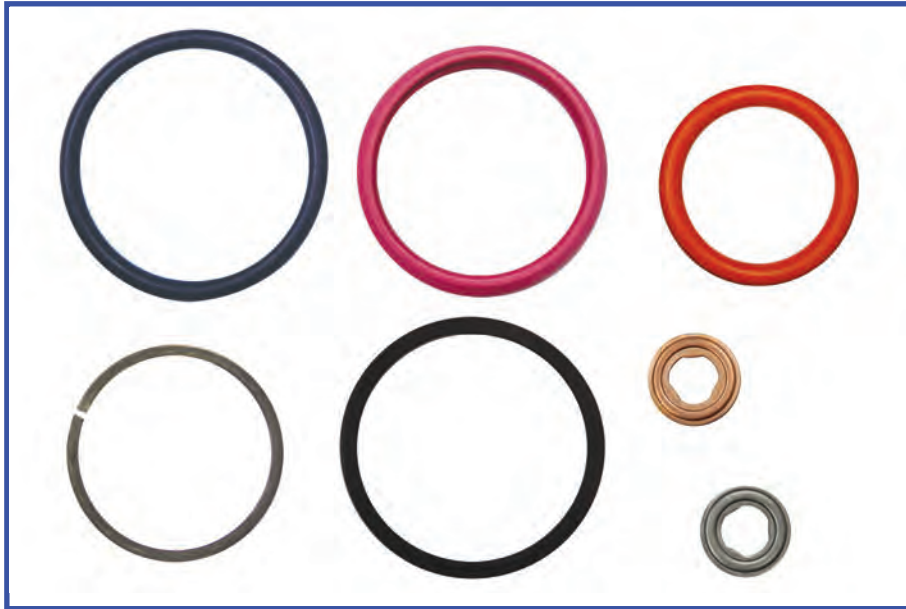

CODICE OMS 11-23-490

KIT ESTERNO PER
FORD POWESTROKE 7.3
Con parafiamma e anello

SUITABLE

POWERSTROKE 7.3

TIPO-TYPE

NAVISTAR

11-23-***

KIT POMPE TANDEM

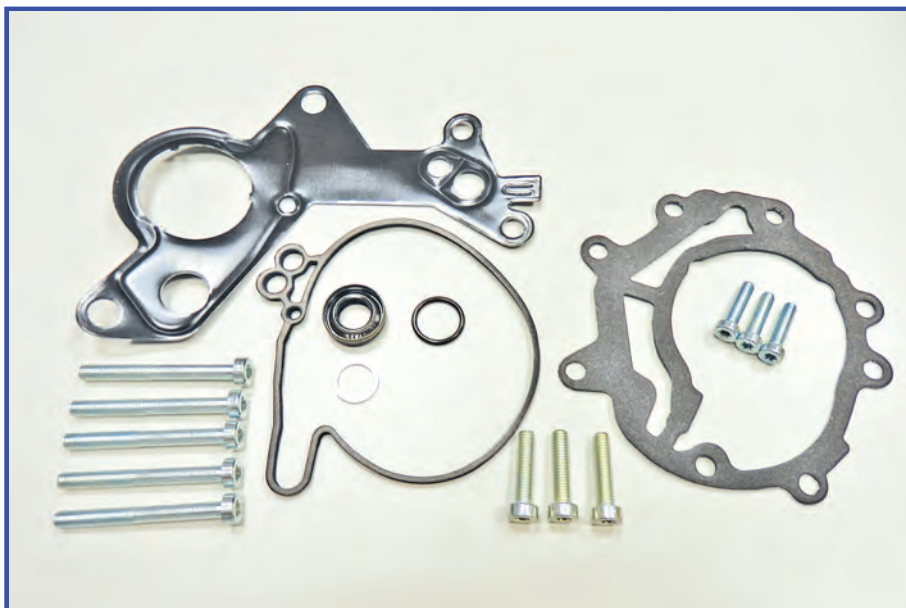

CODICE OMS 11-23-503

KIT TANDEM
038145209M=209Q=
F 009 D02 008

TIPO-TYPE



CODICE OMS 11-23-504

KIT TANDEM
070145209H=F=J=
07Z145209B

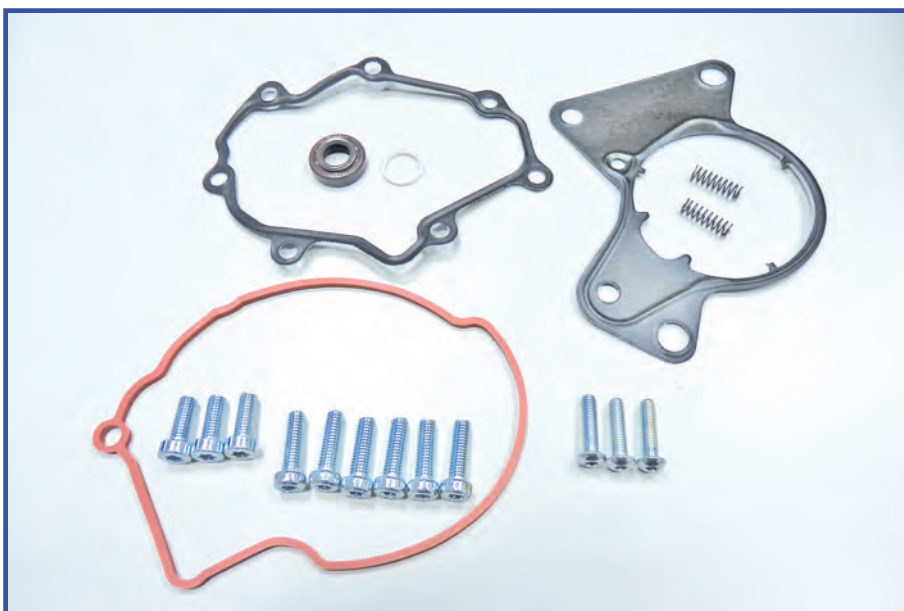

TIPO-TYPE

CODICE OMS 11-23-505

KIT TANDEM
07Z127025F=E



TIPO-TYPE

CODICE OMS 11-23-506

KIT TANDEM
Nr. PUMP 038145101B



TIPO-TYPE



KIT POMPE TANDEM

11-23-***



CODICE OMS 11-23-359/1

KIT TANDEM
11-23-358
+
11-23-359

11-23-358 / 11-23-359
pag .195

TIPO-TYPE



ADATTABILE A / SUITABLE TO : 0 445 120 ***

CODICE OMS 11-23-510

ADATTABILE A :
0 445 120 ***
009/003/004
010/014/015

PER I KIT ADATTABILI A :
0 445 110 ***
VEDI DA PAG.236 A 243

TIPO-TYPE

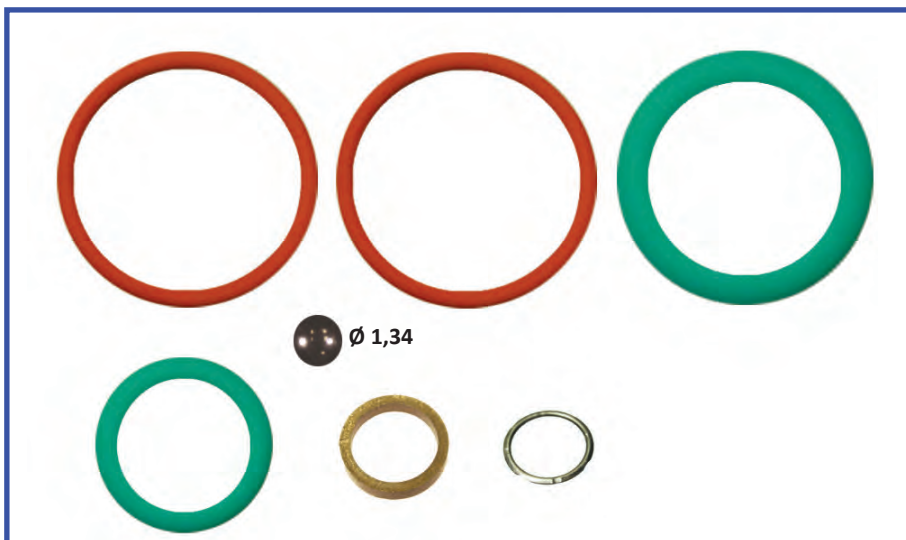

CODICE OMS 11-23-511

ADATTABILE A :
0 445 120 ***
028/006/007/008
012/013/016/017
029/035/037/038
043/044/070/077
079/089/094/097
112/115/120/121
122/125/133/140
144/212/236/237
240/241/272/273

TIPO-TYPE

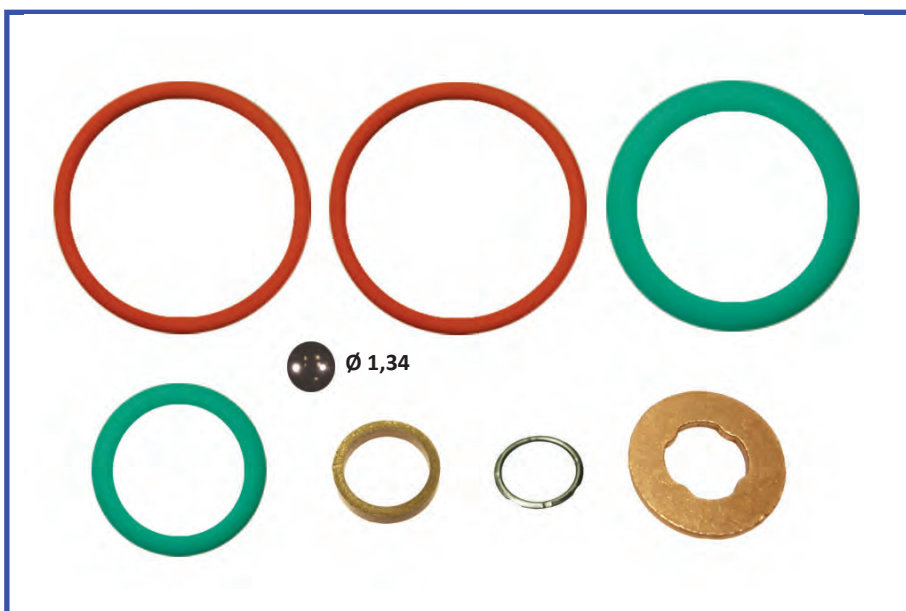



CODICE OMS 11-23-512

ADATTABILE A :
0 445 120 ***
 040/041

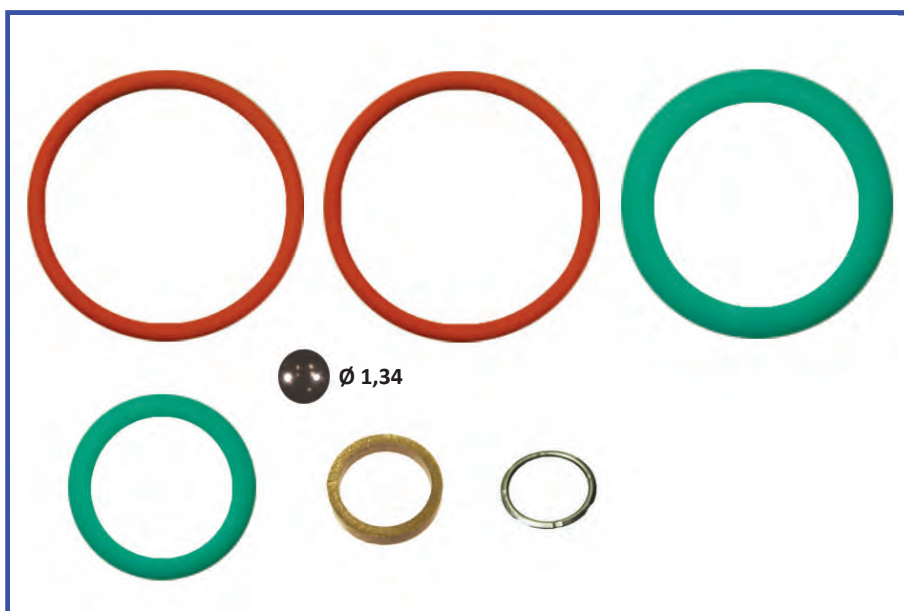

TIPO-TYPE

CODICE OMS 11-23-513

ADATTABILE A :
0 445 120 042



TIPO-TYPE

CODICE OMS 11-23-514

ADATTABILE A :
0 445 120 ***
 045/044/055/056
 068/098/099/105
 147/148/154

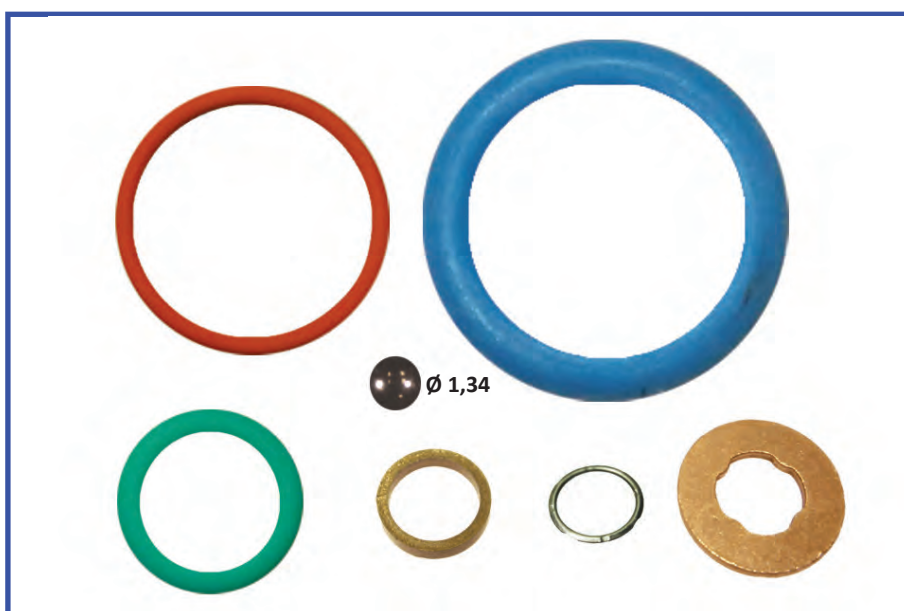

TIPO-TYPE



CODICE OMS 11-23-515

ADATTABILE A :
0 445 110 ***
054/055/082/085
118/134/142/143
153/154/166/172
174/175/214/215
227/229/230/236
262/263/288/294
295/296

0 445 120 ***
048/049/090
091/093/126

TIPO-TYPE

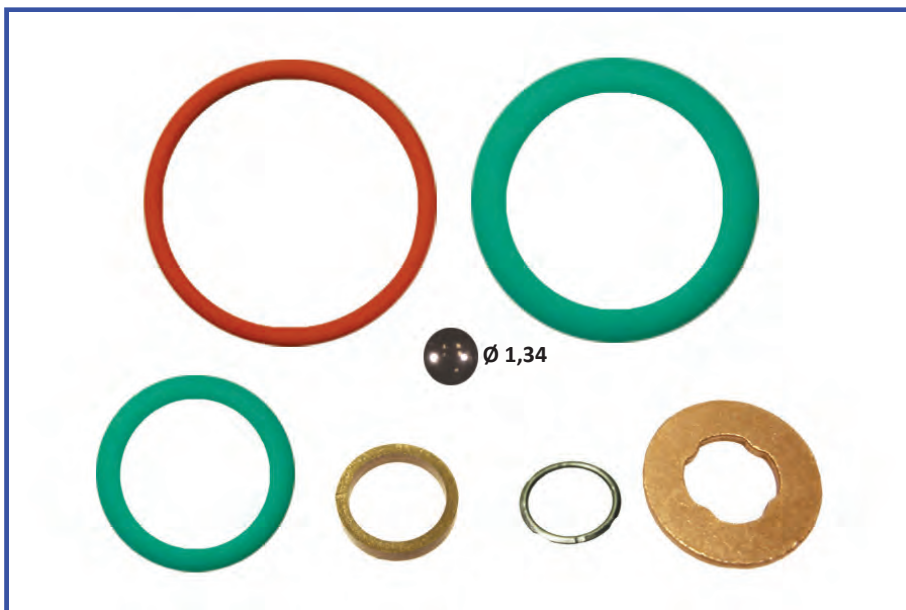

CODICE OMS 11-23-516

ADATTABILE A :
0 445 120 ***
050/071/193

TIPO-TYPE

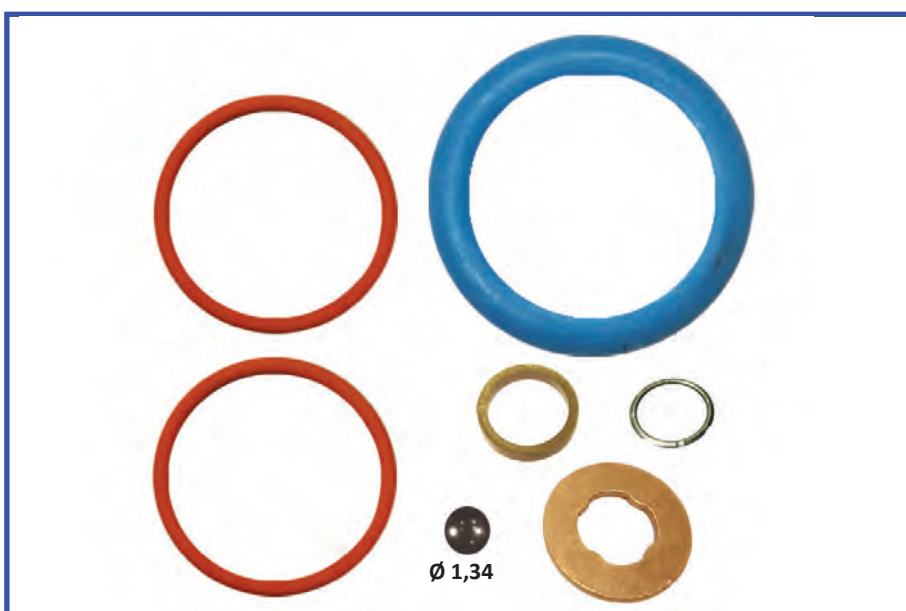

CODICE OMS 11-23-517

ADATTABILE A :
0 445 120 031

TIPO-TYPE



CODICE OMS 11-23-518

ADATTABILE A :

0 445 120 ***

054/057/075

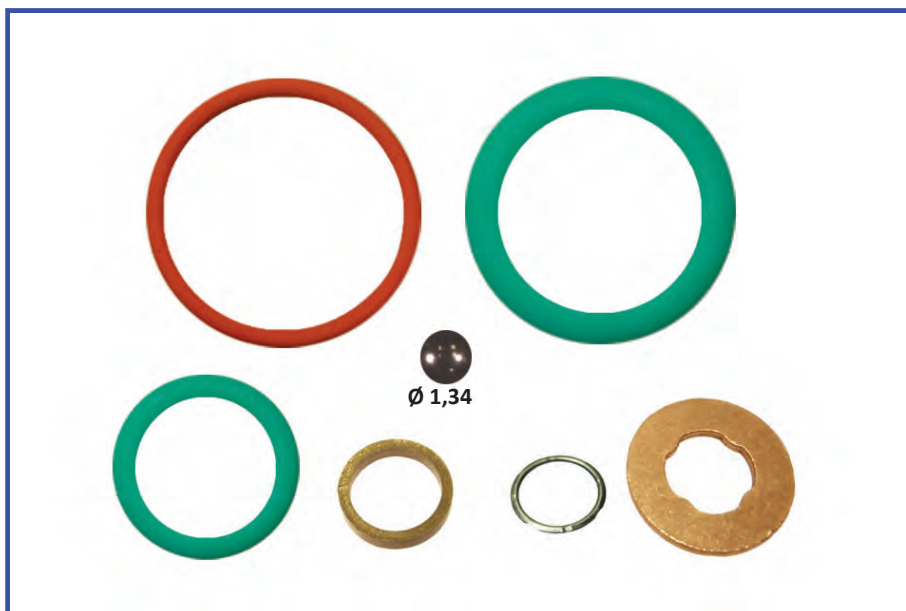

TIPO-TYPE

CODICE OMS 11-23-519

ADATTABILE A :

0 445 110 ***

009/010/011/012/014/015
 020/021/022/023/024/025
 034/035/038/045/046/062
 063/069/070/071/072/073
 074/083/084/090/093/094
 095/096/097/098/099/100
 102/103/104/105/106/107
 108/109/115/116/121/125
 127/141/145/146/151/152
 160/170/171/178/181/182
 187/189/190/195/169/197
 198/199/200/201/202/203
 204/205/206/207/208/221
 224/225/236

0 445 120 ***

002/011/033/034/036/047
 051/052/096/108/173/174
 175



TIPO-TYPE

CODICE OMS 11-23-520

ADATTABILE A :

0 445 120 ***

018/032/046/069
 103/113/114/208
 209/210/211/238
 254/255/256

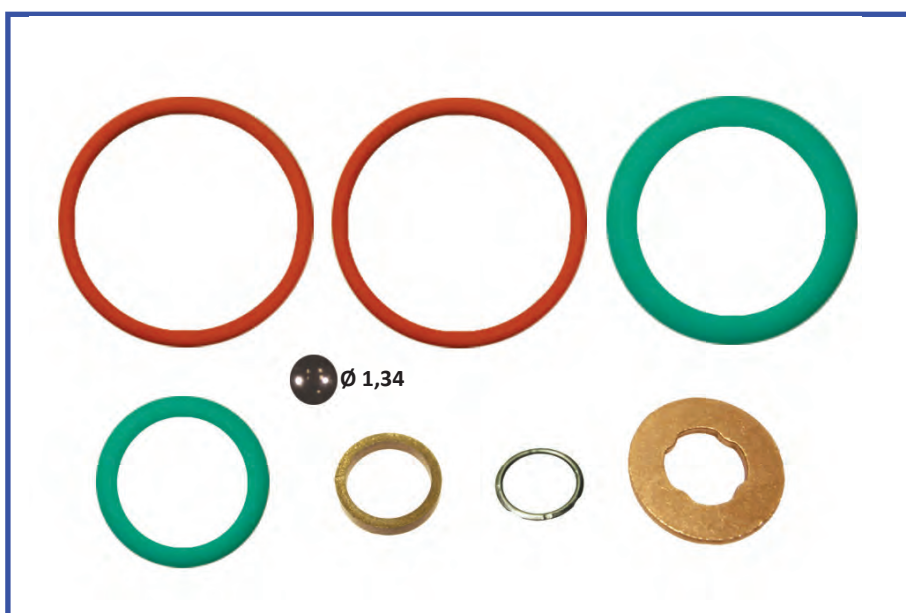

TIPO-TYPE



CODICE OMS 11-23-521

ADATTABILE A :
0 445 120 ***
024/053

TIPO-TYPE



CODICE OMS 11-23-522

ADATTABILE A :
0 445 120 025

TIPO-TYPE



CODICE OMS 11-23-523

ADATTABILE A :
0 445 120 058

TIPO-TYPE



CODICE OMS 11-23-524

ADATTABILE A :
0 445 120 ***
 059/060/123/151
 152/231/239/250
 252



TIPO-TYPE

CODICE OMS 11-23-525

ADATTABILE A :
0 445 120 ***
 062/226

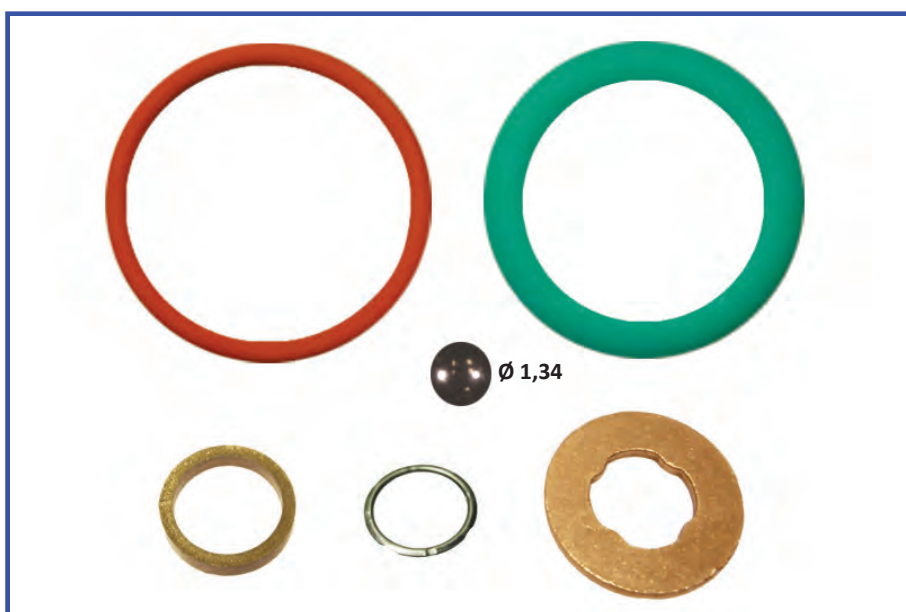

TIPO-TYPE

CODICE OMS 11-23-526

ADATTABILE A :
0 445 120 063

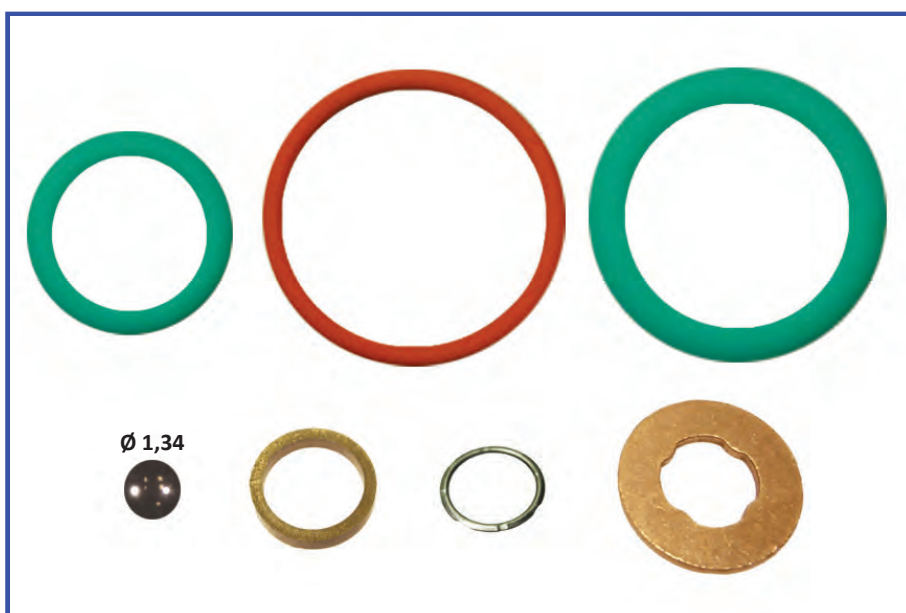

TIPO-TYPE

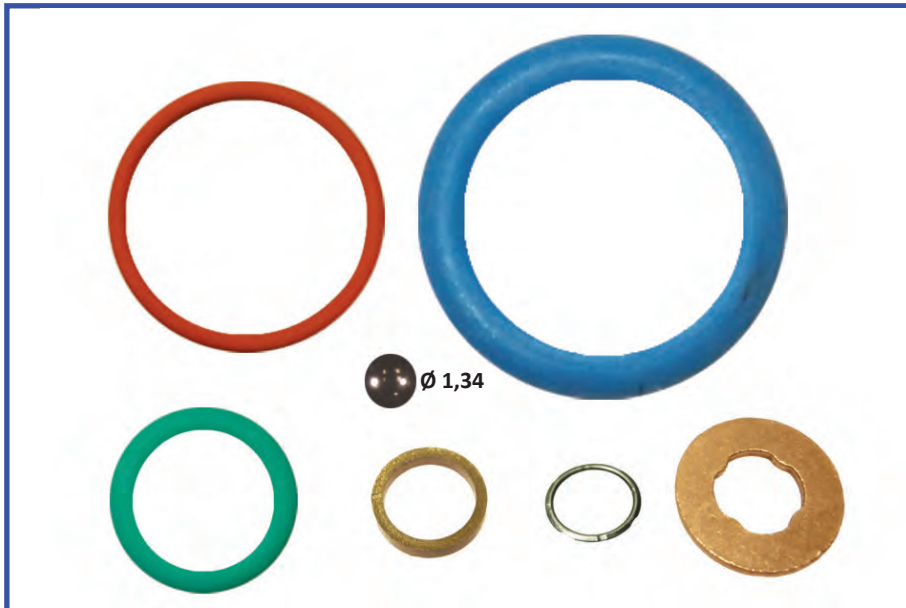

CODICE OMS 11-23-527

ADATTABILE A :
0 445 120 ***
065/064/074/136
137/138/139

TIPO-TYPE

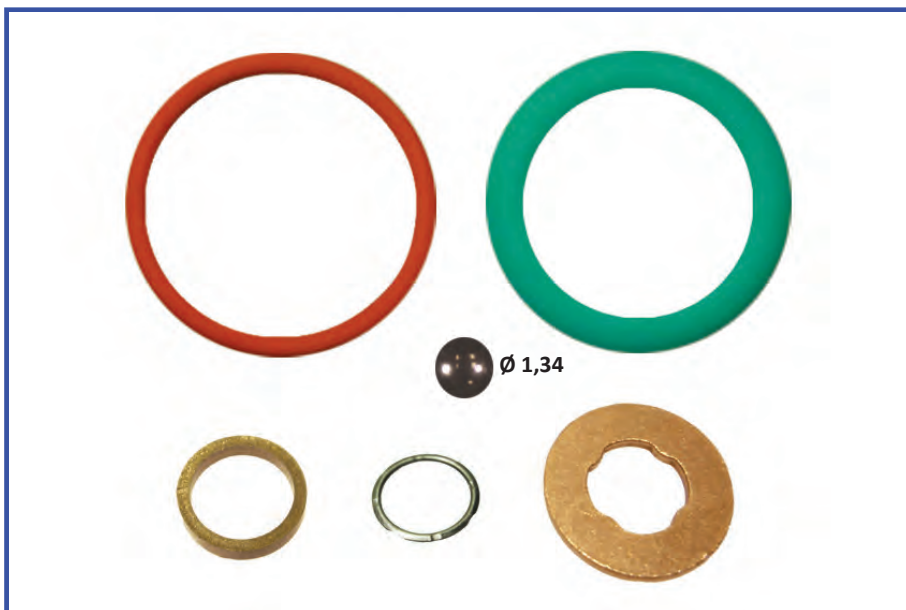

CODICE OMS 11-23-528

ADATTABILE A :
0 445 120 ***
066/067

TIPO-TYPE



CODICE OMS 11-23-529

ADATTABILE A :
0 445 120 ***
072/073/076

TIPO-TYPE



CODICE OMS 11-23-530

ADATTABILE A :
0 445 120 ***
 078/080/027/124/141

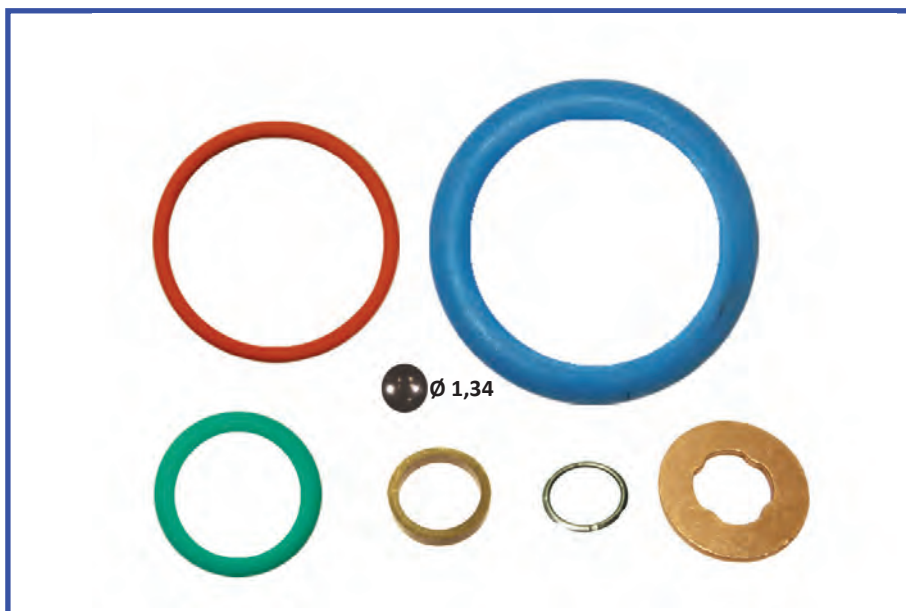

TIPO-TYPE

CODICE OMS 11-23-531

ADATTABILE A :
0 445 120 082



TIPO-TYPE

CODICE OMS 11-23-532

ADATTABILE A :
0 445 120 ***
 083/110

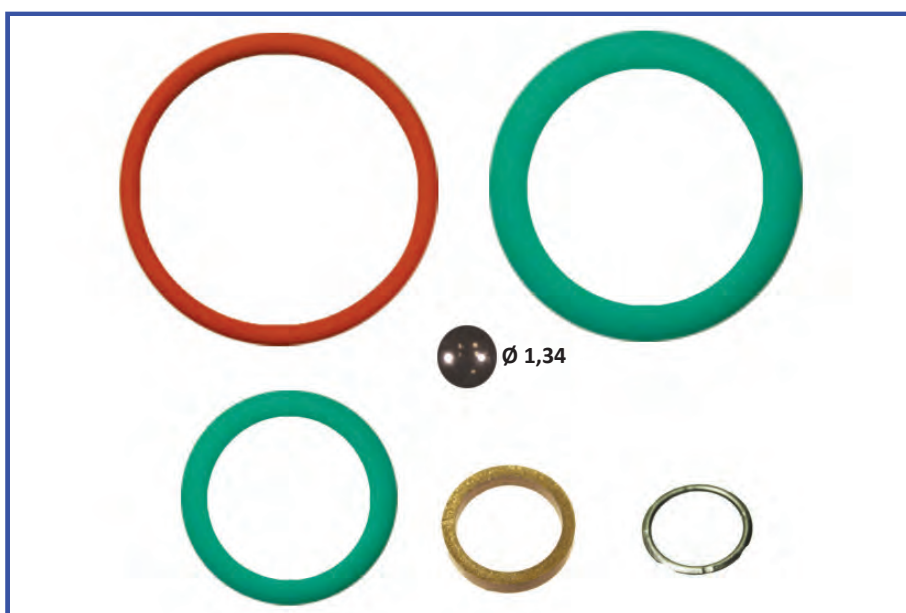

TIPO-TYPE

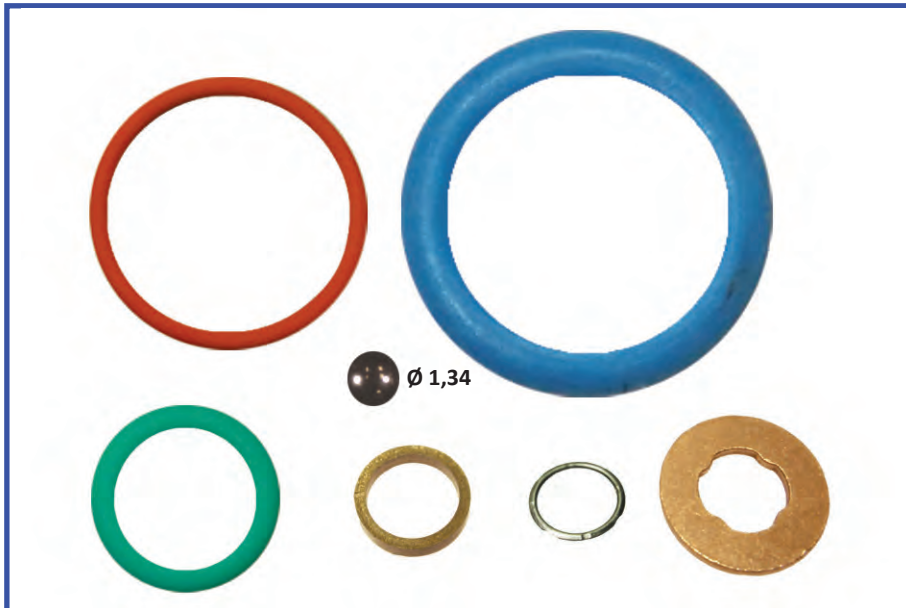

CODICE OMS 11-23-533

ADATTABILE A :
0 445 120 ***
086/087/127

TIPO-TYPE



CODICE OMS 11-23-534

ADATTABILE A :
0 445 120 095

TIPO-TYPE

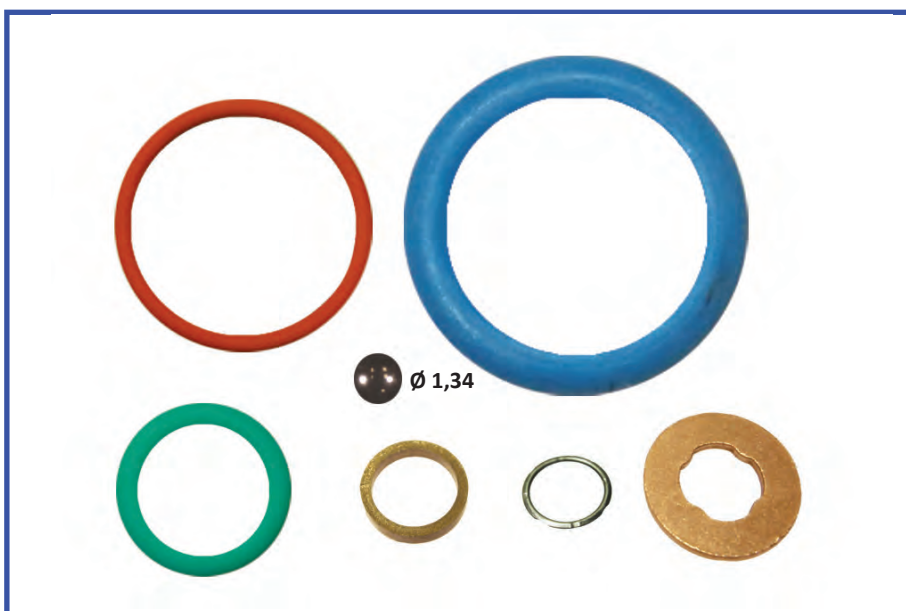

CODICE OMS 11-23-535

ADATTABILE A :
0 445 120 102

TIPO-TYPE



CODICE OMS 11-23-536

ADATTABILE A :
0 445 120 109



TIPO-TYPE

CODICE OMS 11-23-537

ADATTABILE A :
0 445 120 ***
116/092/135/168

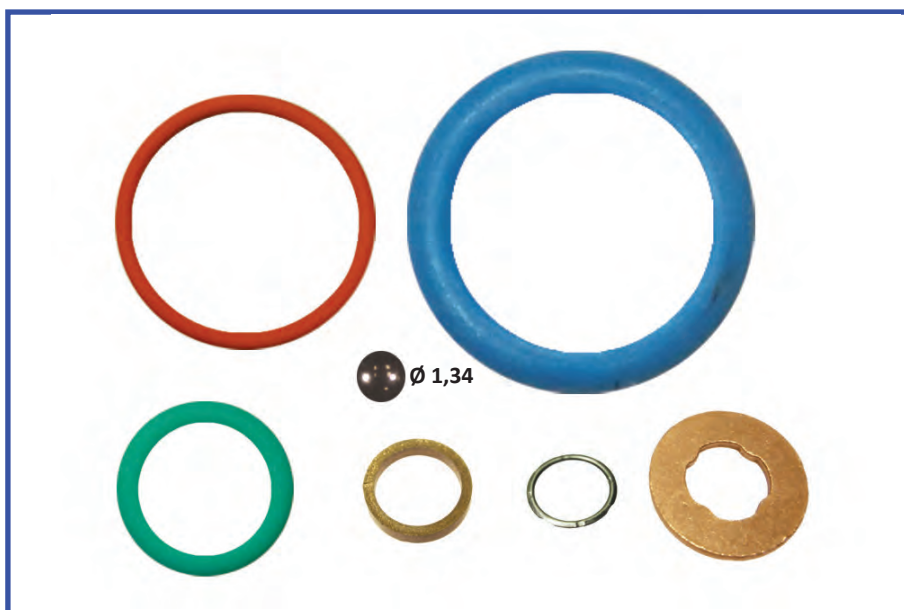

TIPO-TYPE

CODICE OMS 11-23-538

ADATTABILE A :
0 445 120 ***
118/143/155/179
180/197/229

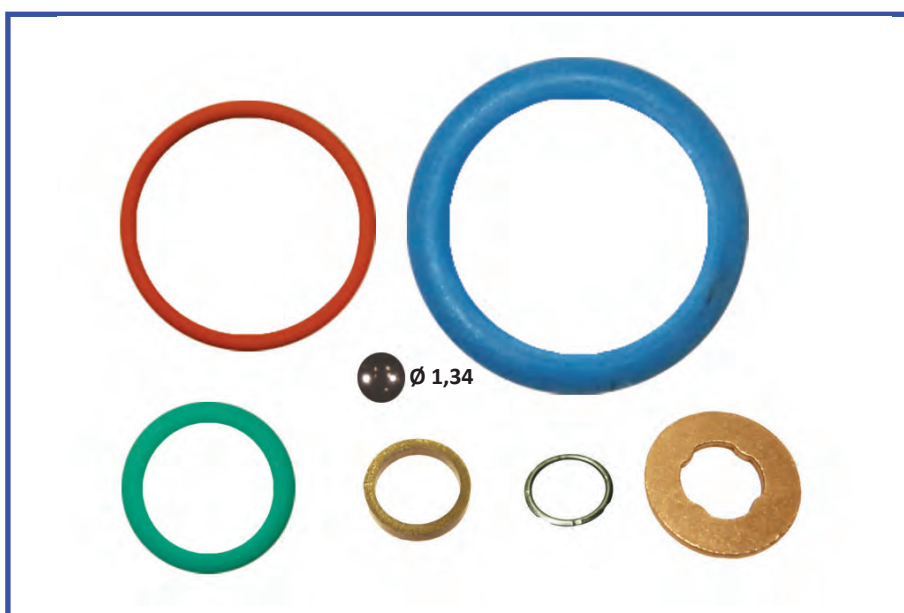

TIPO-TYPE

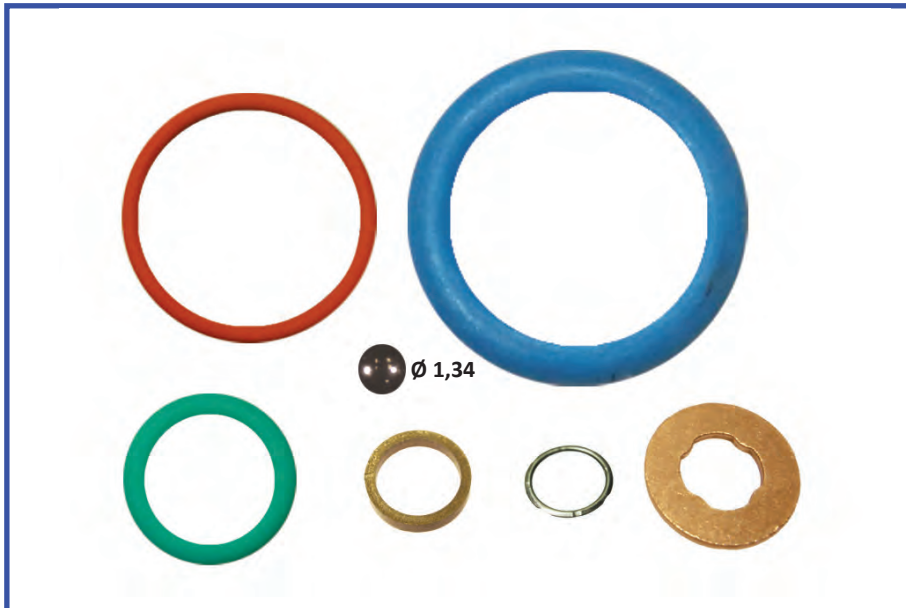

CODICE OMS 11-23-539

ADATTABILE A :
0 445 120 ***
128/131/196/203

TIPO-TYPE

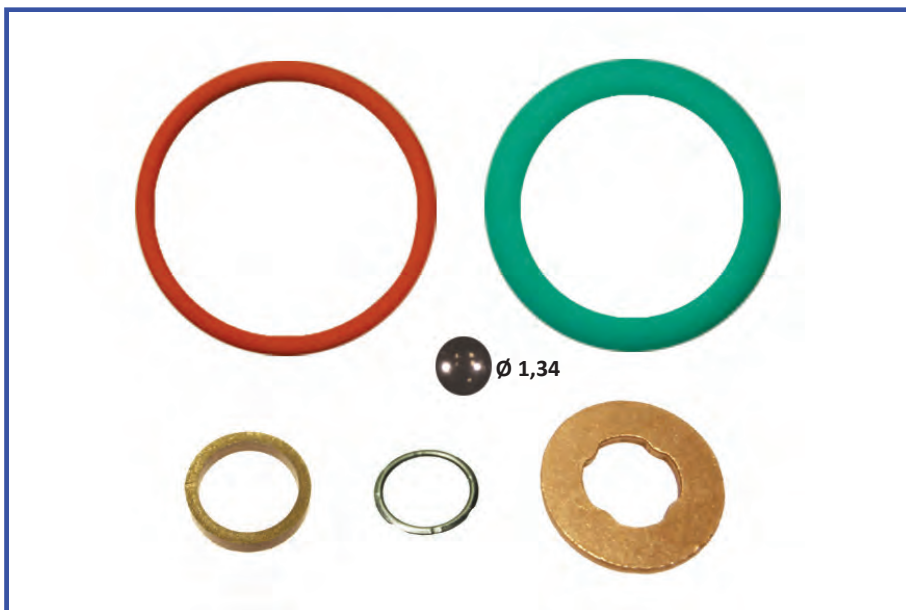

CODICE OMS 11-23-540

ADATTABILE A :
0 445 120 ***
129/081/149/150
153/169/170/200

TIPO-TYPE

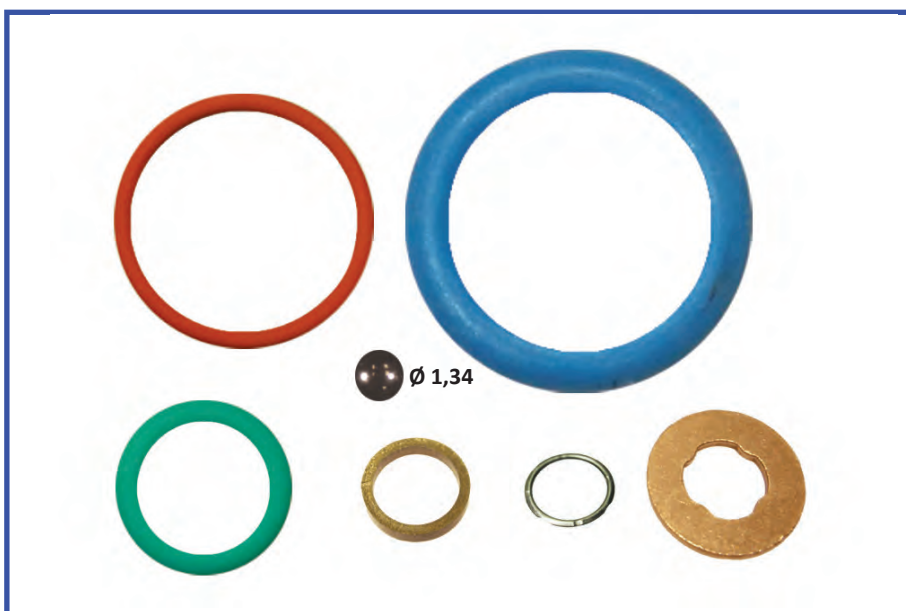

CODICE OMS 11-23-541

ADATTABILE A :
0 445 120 ***
162/186

TIPO-TYPE



CODICE OMS 11-23-542

ADATTABILE A :
0 445 120 215

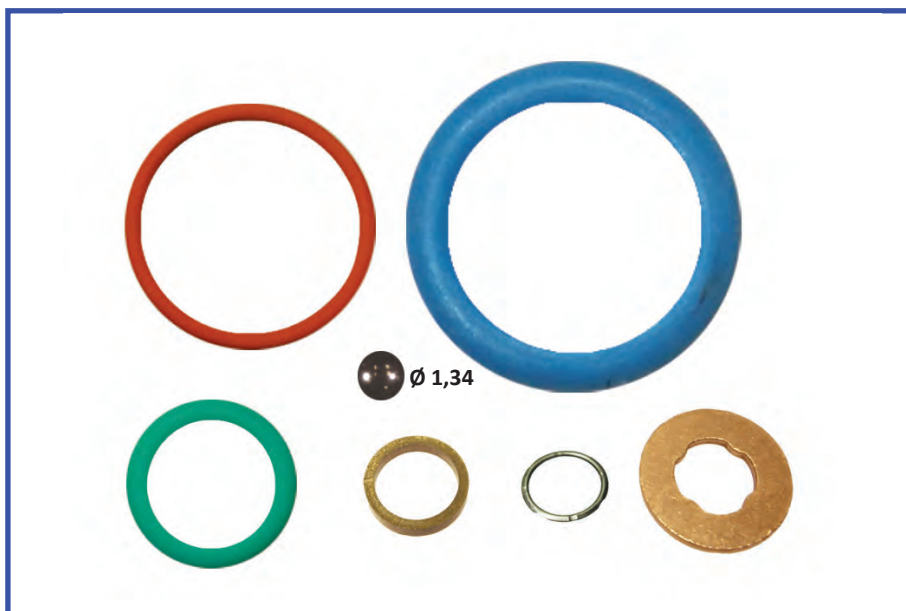

TIPO-TYPE

CODICE OMS 11-23-543

ADATTABILE A :
0 445 120 ***
030/217/218/219

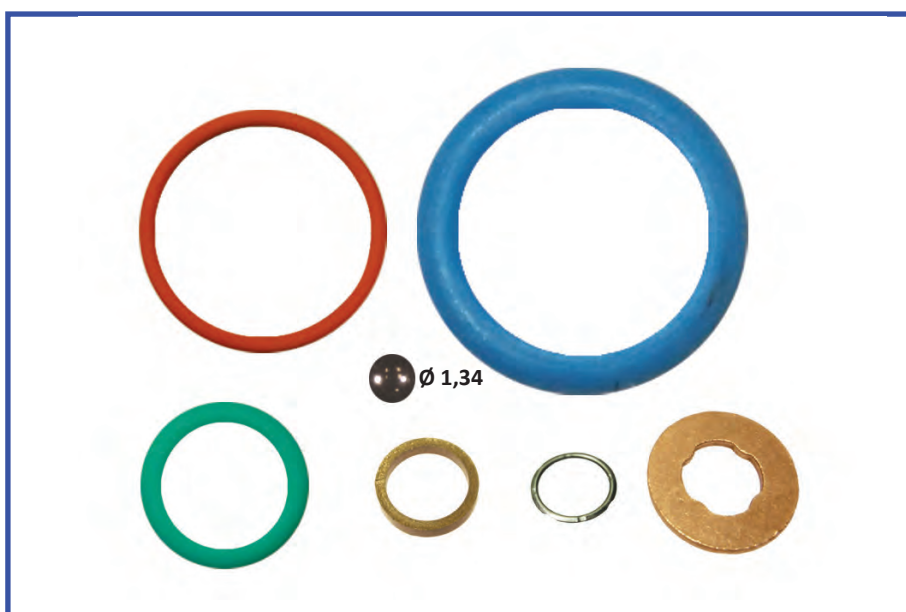

TIPO-TYPE

CODICE OMS 11-23-544

ADATTABILE A :
0 445 120 258



TIPO-TYPE



11-23-***



CODICE OMS 11-23-545

ADATTABILE A :
0 445 120 289

TIPO-TYPE

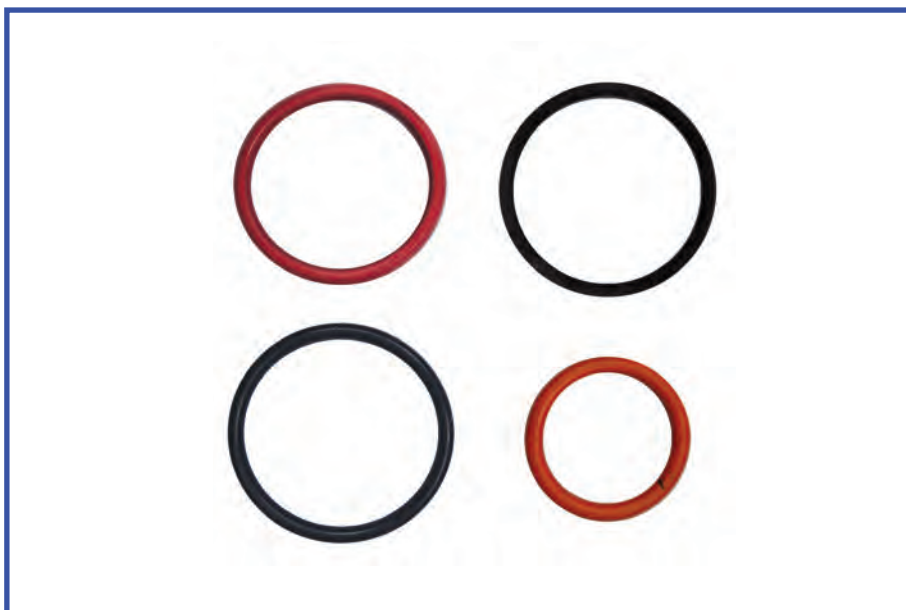

CODICE OMS 11-23-566

KIT ESTERNO PER
FORD POWESTROKE 7.3

SUTABE
POWERSTROKE 7.3

TIPO-TYPE NAVISTAR



CODICE OMS 11-23-567

KIT VITI PER
FORD POWESTROKE 7.3

SUTABE
POWERSTROKE 7.3

TIPO-TYPE NAVISTAR



CODICE OMS 11-23-576

KIT ESTERNO PER
FORD POWESTROKE 6.0/4.5

SUTABILE
POWERSTROKE 6.0/4.5

TIPO-TYPE NAVISTAR



CODICE OMS 11-23-577

KIT INTERNO PER
FORD POWESTROKE 6.0/4.5

SUTABILE
POWERSTROKE 6.0/4.5

TIPO-TYPE NAVISTAR

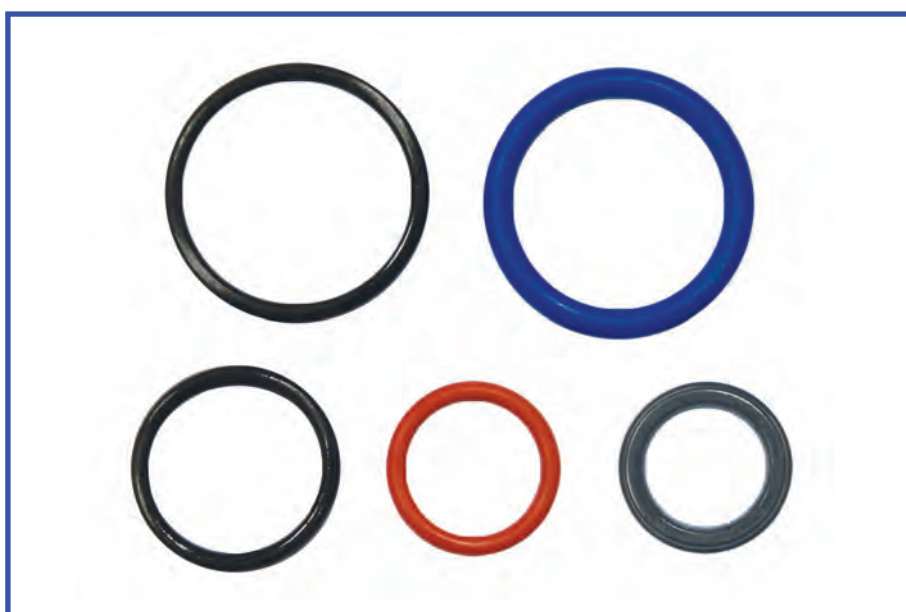

CODICE OMS 11-23-578

KIT COMPLETO PER
FORD POWESTROKE 6.0/4.5

SUTABILE
POWERSTROKE 6.0/4.5

TIPO-TYPE NAVISTAR





11-23-***



CODICE OMS 11-23-579

KIT VITI PER
FORD POWESTROKE 6.0/4.5

SUITABLE
POWERSTROKE 6.0/4.5

TIPO-TYPE NAVISTAR

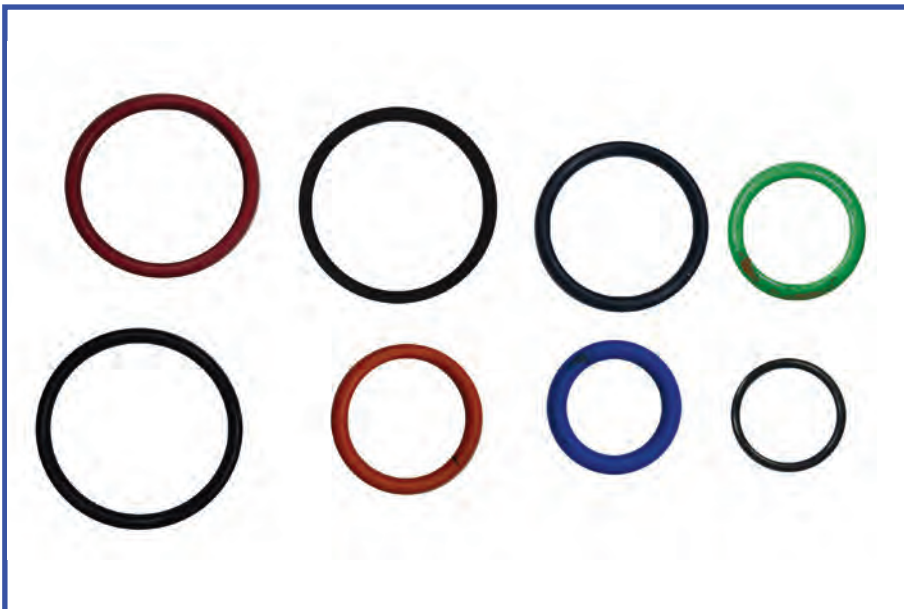

CODICE OMS 11-23-580

KIT COMPLETO PER
FORD POWESTROKE 7.3

SUITABLE
POWERSTROKE 7.3

TIPO-TYPE NAVISTAR

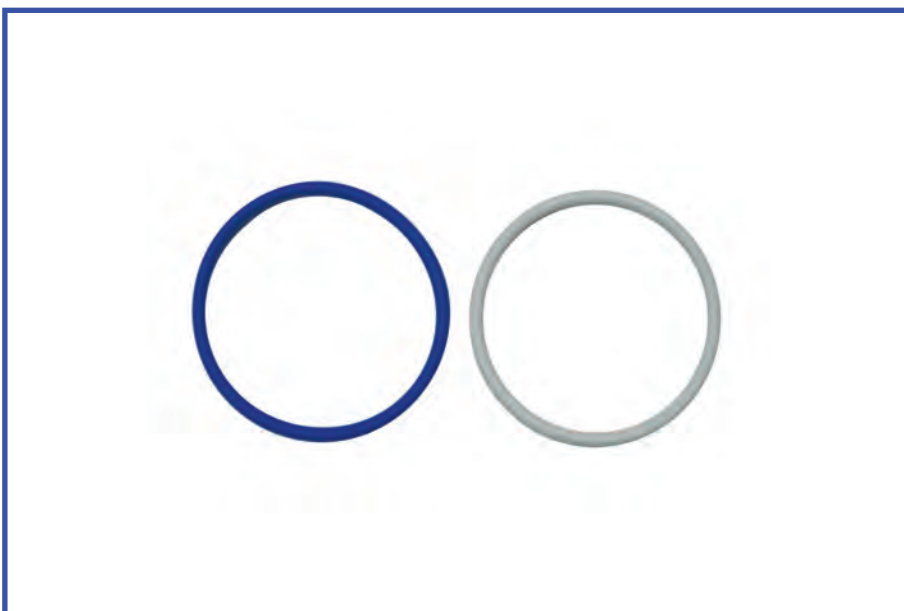

CODICE OMS 11-23-584

KIT ESTERNO PER
CUMMINS N14

SUITABLE
POWERSTROKE 7.3

TIPO-TYPE CUMMINS



CODICE OMS 11-23-585

KIT INTERNO PER
CUMMINS N14

SUTTABLE

CUMMINS

TIPO-TYPE CUMMINS

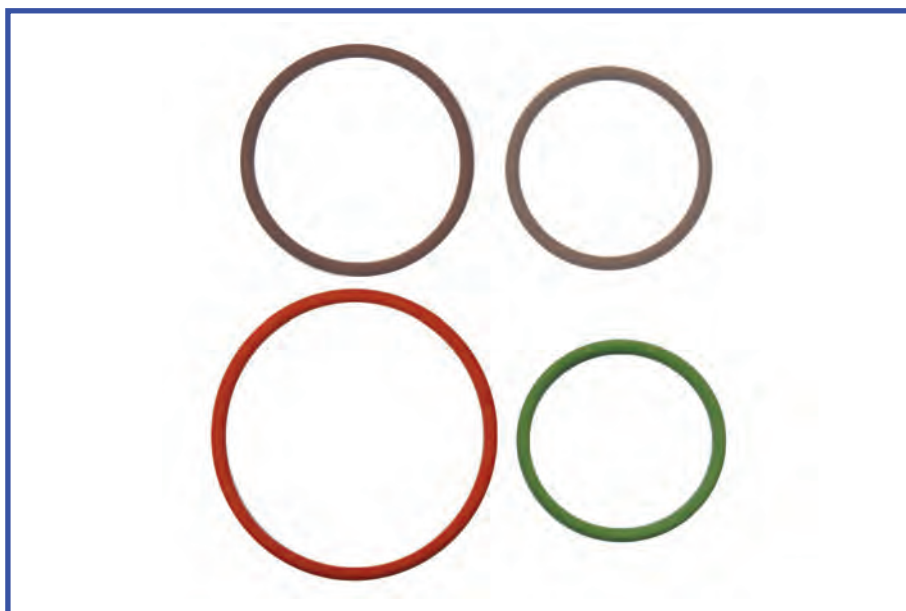

CODICE OMS 11-23-586

KIT COMPLETO PER
CUMMINS N14

SUTTABLE

CUMMINS

TIPO-TYPE CUMMINS

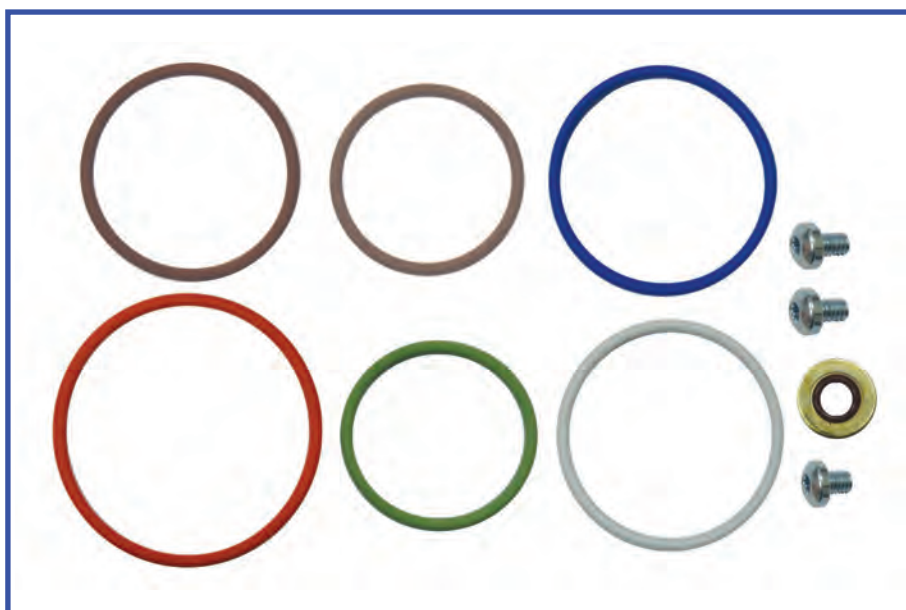

CODICE OMS 11-23-593

KIT INTERNO PER
DETROIT DIESEL SERIES
50/60

SUTTABLE

DETROIT DIESEL 50/60

TIPO-TYPE DETROIT DIESEL

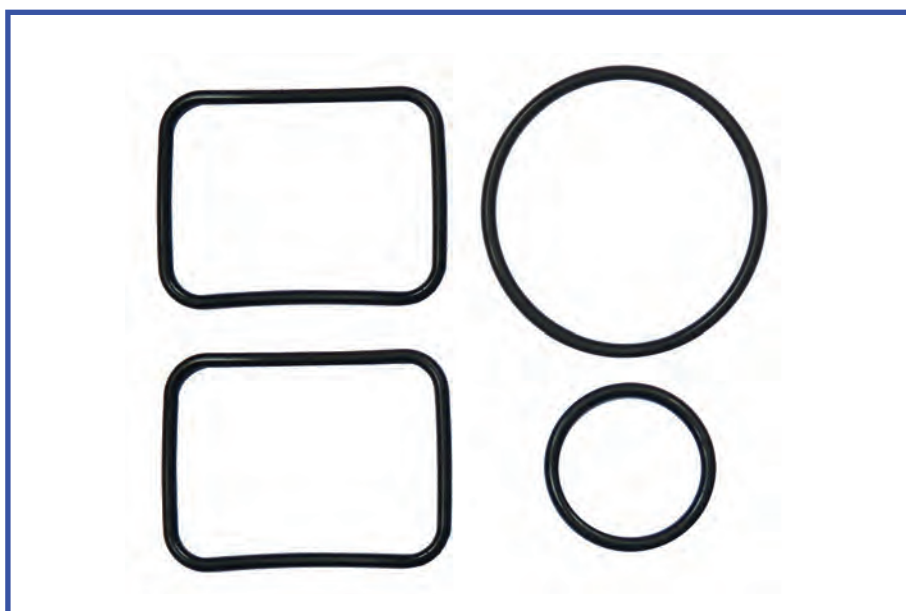



11-23-***



CODICE OMS 11-23-594

KIT ESTERNO PER
DETROIT DIESEL SERIES
50/60

SUTABLE
DETROIT DIESEL 50/60

TIPO-TYPE DETROIT DIESEL

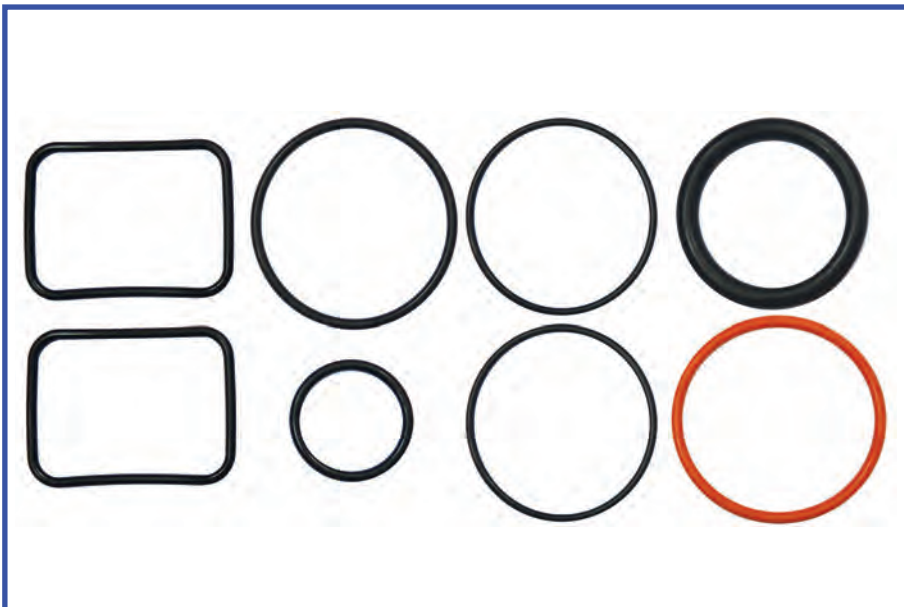

CODICE OMS 11-23-595

KIT COMPLETO PER
DETROIT DIESEL SERIES
50/60

SUTABLE
DETROIT DIESEL 50/60

TIPO-TYPE DETROIT DIESEL



CODICE OMS 11-23-596

KIT VITI PER
DETROIT DIESEL SERIES
50/60

SUTABLE
DETROIT DIESEL 50/60

TIPO-TYPE DETROIT DIESEL



CODICE OMS 11-23-600

KIT INTERNO PER
CATERPILLAR 3500

SUITABLE

CATERPILLAR 3500

TIPO-TYPE

CATERPILLAR

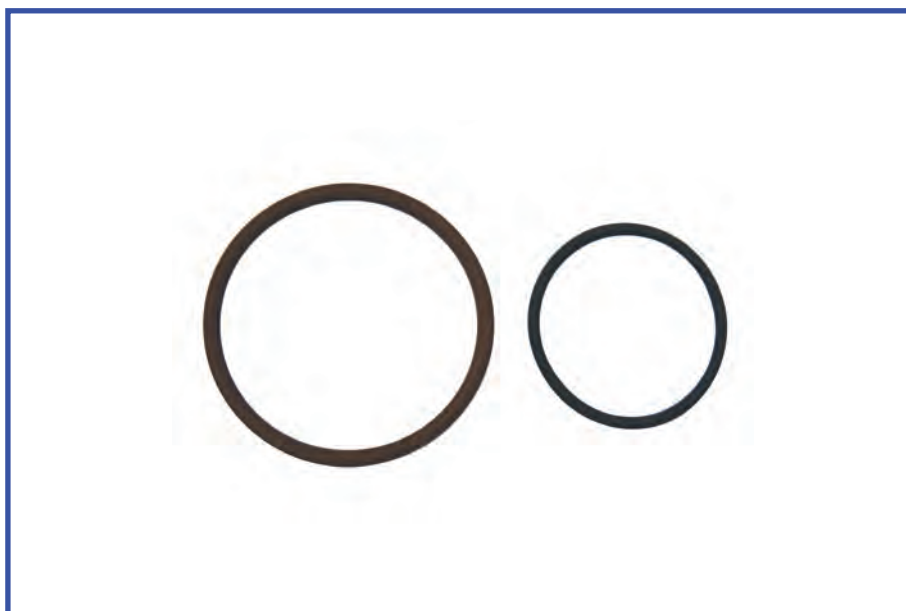

CODICE OMS 11-23-601

KIT ESTERNO PER
CATERPILLAR 3500

SUITABLE

CATERPILLAR 3500

TIPO-TYPE

CATERPILLAR



CODICE OMS 11-23-602

KIT COMPLETO PER
CATERPILLAR 3500

SUITABLE

CATERPILLAR 3500

TIPO-TYPE

CATERPILLAR

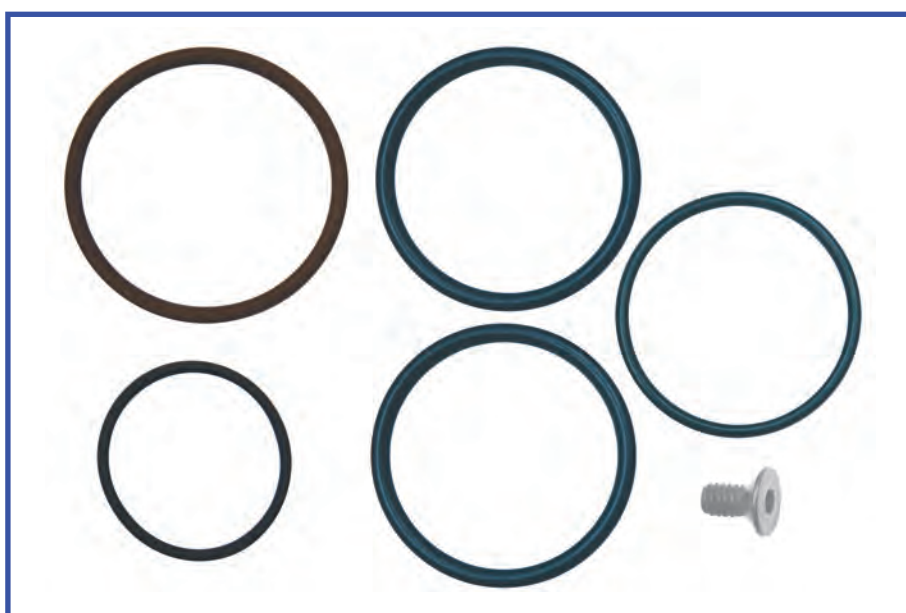

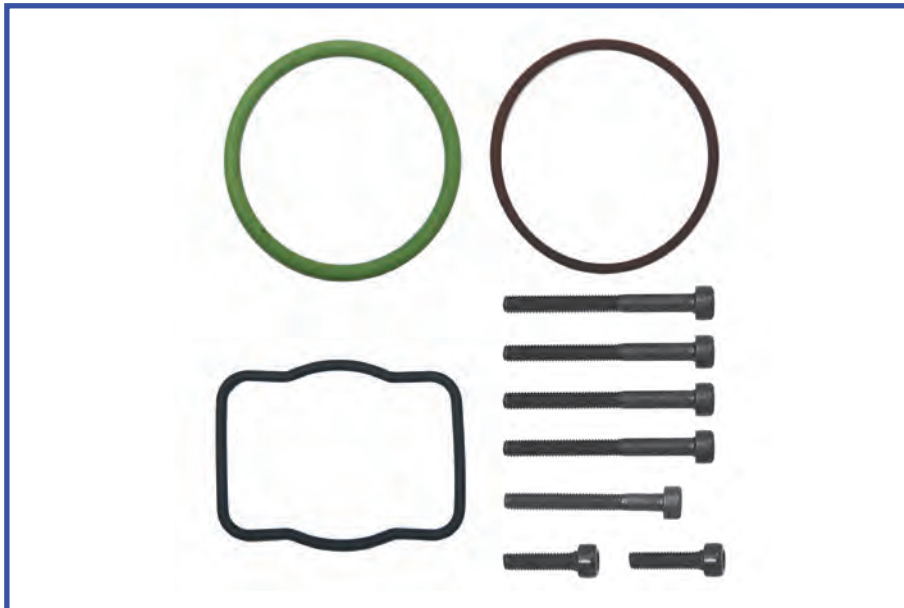

CODICE OMS 11-23-609

KIT INTERNO PER
CATERPILLAR 3516 ESUTABE
CATERPILLAR 3516 E

TIPO-TYPE CATERPILLAR

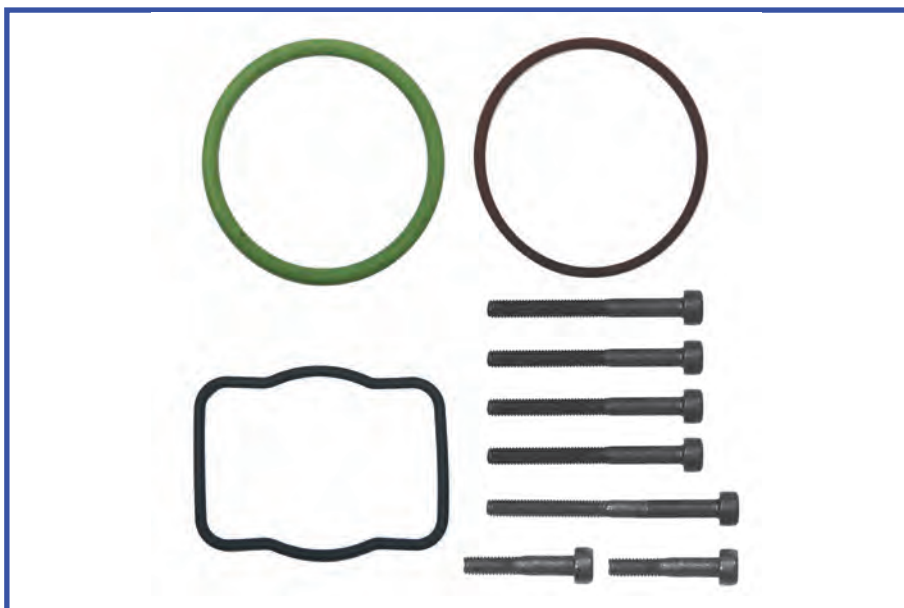

CODICE OMS 11-23-610

KIT INTERNO PER
CATERPILLAR 3516 ESUTABE
CATERPILLAR 3516 E

TIPO-TYPE CATERPILLAR

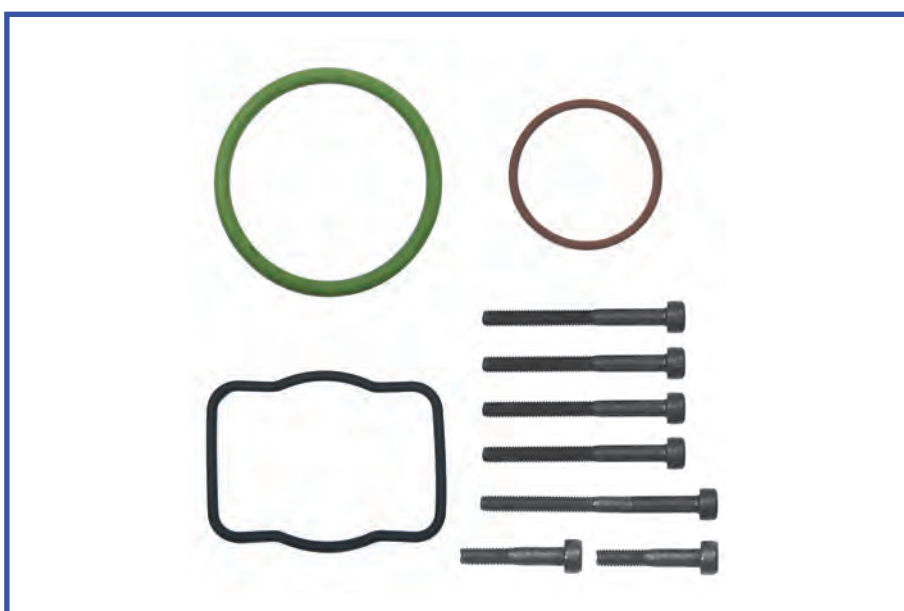

CODICE OMS 11-23-611

KIT INTERNO PER
CATERPILLAR 3516 ESUTABE
CATERPILLAR 3516 E

TIPO-TYPE CATERPILLAR



CODICE OMS 11-23-612

KIT ESTERNO PER
CATERPILLAR 3516 E

SITABE

CATERPILLAR 3516 E

TIPO-TYPE CATERPILLAR



CODICE OMS 11-23-615

KIT RACCORDI
Rif. or. YDT275

TIPO-TYPE DELPHI



CODICE OMS 11-23-616

KIT RACCORDI
Rif. or. YDT276

TIPO-TYPE DELPHI

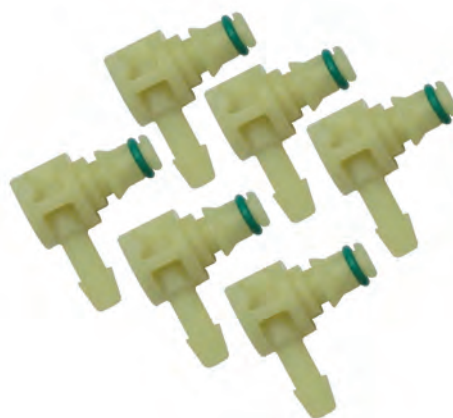



11-23-***



CODICE OMS 11-23-617

KIT RACCORDI

Rif. or. YDT461

TIPO-TYPE DELPHI



CODICE OMS 11-23-618

KIT RACCORDI

Rif. or. YDT462

TIPO-TYPE DELPHI



CODICE OMS 11-23-619

KIT RACCORDI

Rif. or. YDT477

TIPO-TYPE DELPHI



CODICE OMS 11-23-620

KIT RACCORDI

Rif. or. YDT478



TIPO-TYPE DELPHI

CODICE OMS 11-23-621

KIT RACCORDI

Rif. or. YDT514



TIPO-TYPE DELPHI

CODICE OMS 11-23-622

KIT RACCORDI

Rif. or. YDT531



TIPO-TYPE DELPHI



11-23-***

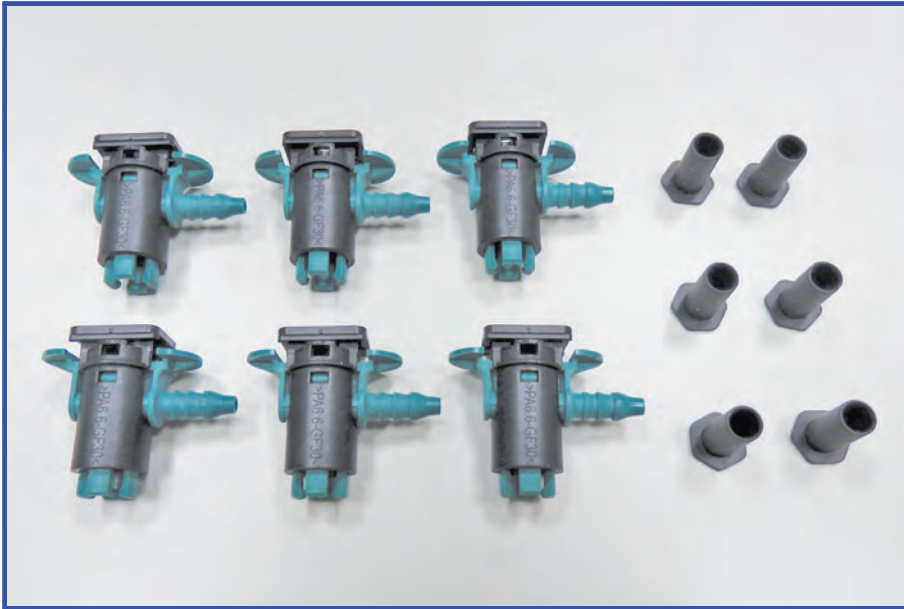

CODICE OMS 11-23-623

KIT RACCORDI

Rif. or. YDT561

TIPO-TYPE DELPHI



CODICE OMS 11-23-624

KIT RACCORDI

Rif. or. YDT462

TIPO-TYPE DELPHI



CODICE OMS 11-23-625

KIT RACCORDI

Rif. or. YDT563

TIPO-TYPE DELPHI



CODICE OMS 11-23-628

KIT VITI PER
CATERPILLAR 3126 HEUI

SUITABLE
CATERPILLAR 3126 HEUI

TIPO-TYPE CATERPILLAR



CODICE OMS 11-23-629

KIT INTERNO PER
CATERPILLAR 3126 HEUI

SUITABLE
CATERPILLAR 3126 HEUI

TIPO-TYPE CATERPILLAR



CODICE OMS 11-23-630

KIT ESTERNO PER
CATERPILLAR 3126 HEUI

SUITABLE
CATERPILLAR 3126 HEUI

TIPO-TYPE CATERPILLAR

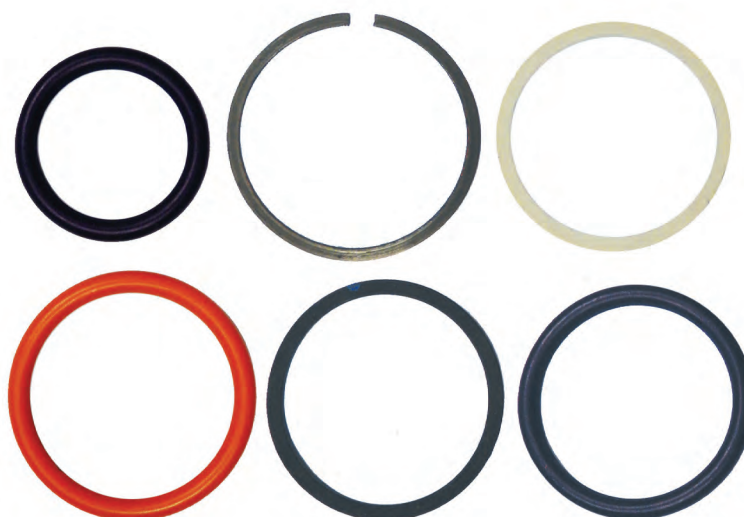



11-23-***

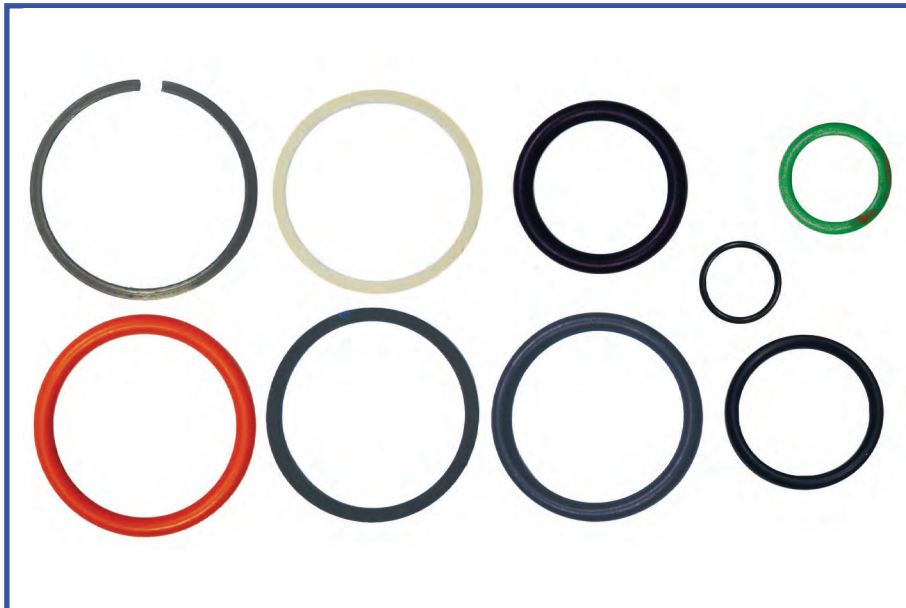

CODICE OMS 11-23-631

KIT COMPLETO PER
CATERPILLAR 3126 HEUI

SUITABLE
CATERPILLAR 3126 HEUI

TIPO-TYPE CATERPILLAR

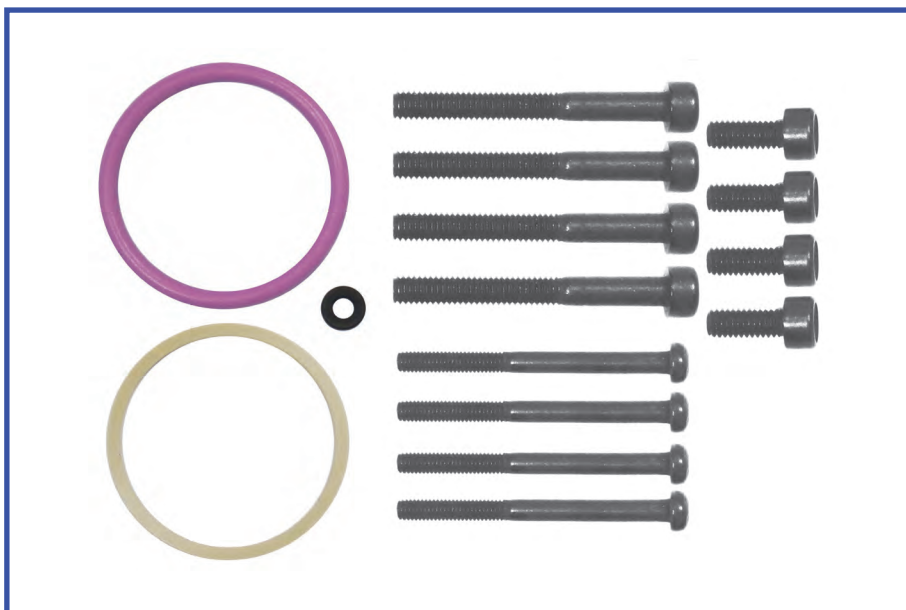

CODICE OMS 11-23-639

KIT INTERNO PER
CATERPILLAR C 9 HEUI

SUITABLE
CATERPILLAR C 9 HEUI

TIPO-TYPE CATERPILLAR



CODICE OMS 11-23-640

KIT ESTERNO PER
CATERPILLAR C 9 HEUI

SUITABLE
CATERPILLAR C 9 HEUI

TIPO-TYPE CATERPILLAR



CODICE OMS 11-23-641

KIT COMPLETO PER
CATERPILLAR C 9 HEUI

SETTABLE

CATERPILLAR C 9 HEUI

TIPO-TYPE

CATERPILLAR



CODICE OMS 11-23-642

KIT PDE 100

F 00H N34 702
+
F 00H N37 860
+
F 00H N37 331

TIPO-TYPE

PDE 100

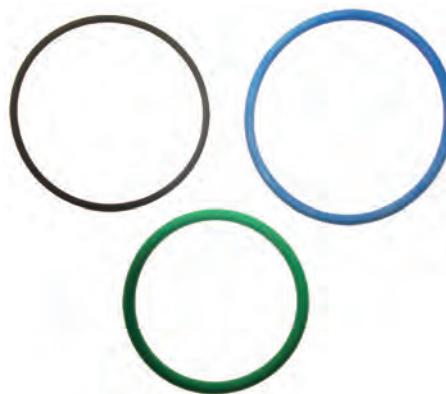

CODICE OMS 11-23-643

KIT RACCORDI

Rif. or. YDT414

TIPO-TYPE

DELPHI





11-23-***



CODICE OMS 11-23-644

KIT RACCORDI

Rif. or. YDT419

TIPO-TYPE DELPHI

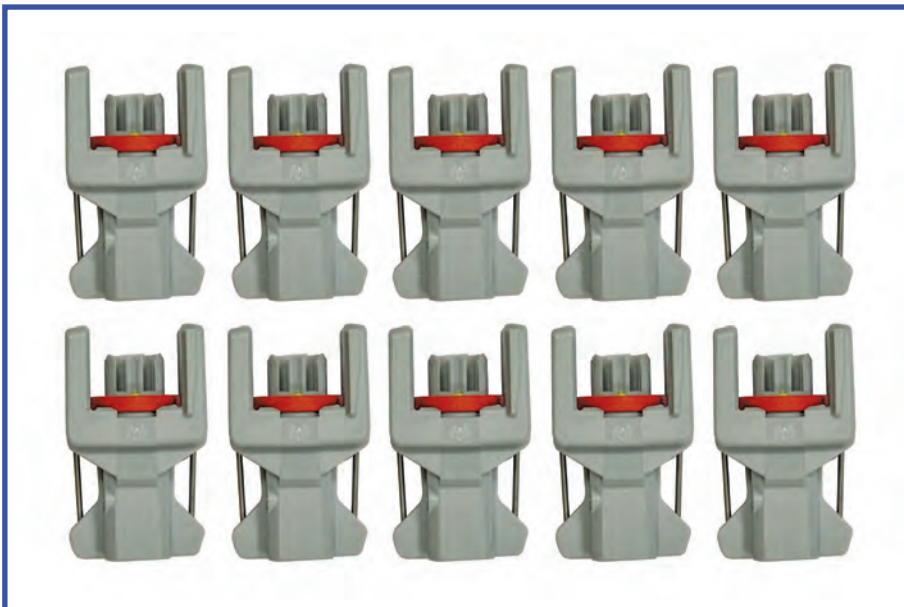

CODICE OMS 11-23-645

KIT RACCORDI

Rif. or. YDT545

TIPO-TYPE DELPHI

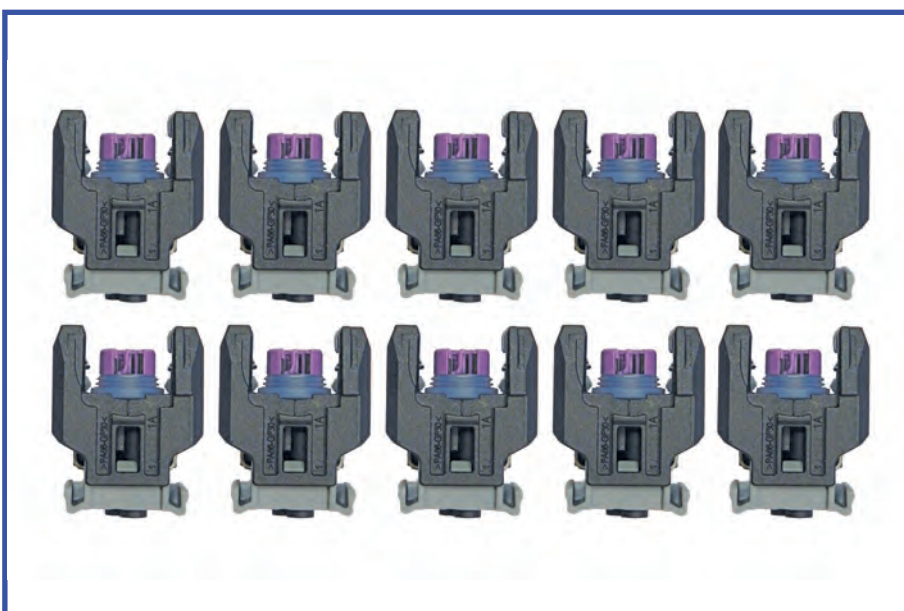

CODICE OMS 11-23-646

KIT RACCORDI

Rif. or. YDT546

TIPO-TYPE DELPHI



CODICE OMS 11-23-654

KIT PER POMPA CR
Rif. or. 7135-477



TIPO-TYPE DELPHI

CODICE OMS 11-23-655

GASKET KIT

n°	Descrizione	Cod. OMS	Rif. originale	Misure
1	O-RING	14-15-243	-	Ø 21x1,5
1	SFERA	11-23-208	F 00V C05 001	Ø 1,34
1	RONDELLA + LAMIERINO	11-23-212	F 00R J02 176 + F 00V C99 002	-
1	RONDELLA ACCIAIO	11-23-209	F 00V C17 002	9x6x1
1	RONDELLA RAME	14-05-226	Mercedes	8x15x1,56



TIPO-TYPE

CODICE OMS 11-23-656

GASKET KIT

n°	Descrizione	Cod. OMS	Rif. originale	Misure
1	SFERA	11-23-208	F 00V C05 001	Ø 1,34
1	RONDELLA + LAMIERINO	11-23-212	F 00R J02 176 + F 00V C99 002	-



TIPO-TYPE



CODICE OMS 11-23-657

GASKET KIT

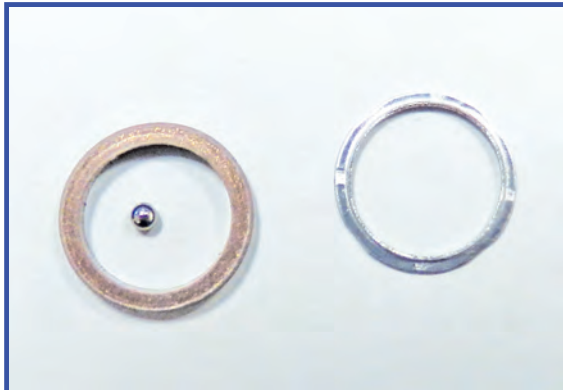

n°	Descrizione	Cod. OMS	Rif. originale	Misure
1	SFERA	-	-	Ø 1,50
1	RONDELLA + LAMIERINO	11-23-212	F 00R J02 176 + F 00V C99 002	-

TIPO-TYPE

CODICE OMS 11-23-658

GASKET KIT



n°	Descrizione	Cod. OMS	Rif. originale	Misure
1	O-RING	14-15-243	-	Ø 21x1,5
1	SFERA	11-23-208	-	Ø 1,34
1	RONDELLA + LAMIERINO	11-23-212	F 00R J02 176 + F 00V C99 002	-
1	RONDELLA RAME	14-05-255	FORD TRANSIT	7,4x14,6x2
1	RONDELLA ACCIAIO	11-23-209	F 00V C17 002	9x6x1

TIPO-TYPE

CODICE OMS 11-23-659

GASKET KIT



n°	Descrizione	Cod. OMS	Rif. originale	Misure
1	O-RING VITON	14-15-140	2 430 210 082	Ø 11x3
1	O-RING VITON	14-15-137	2 430 210 081	Ø 21x3
2	O-RING VITON	14-15-162	F 00R J00 220	Ø 24x1,5
1	RONDELLA + LAMIERINO	11-23-212	F 00R J02 176 + F 00V C99 002	-
1	RONDELLA RAME	14-05-229	F 00V C17 503	7,4x14,6x2

TIPO-TYPE



CODICE OMS 11-23-660

GASKET KIT

n°	Descrizione	Cod. OMS	Rif. originale	Misure
1	O-RING VITON	14-10-246	-	Ø 17x1,8
2	O-RING VITON	14-15-162	F 00R J00 220	Ø 24x1,5
1	SFERA	11-23-208	F 00V C05 001	Ø 1,34
1	RONDELLA + LAMIERINO	11-23-212	F 00R J02 176 + F 00V C99 002	-
1	RONDELLA RAME	14-05-223	F 00V C17 504	7,5x15x2



TIPO-TYPE

CODICE OMS 11-23-661

GASKET KIT

n°	Descrizione	Cod. OMS	Rif. originale	Misure
1	O-RING VITON	14-15-210	F 00H N35 985	Ø 9x2,5
1	O-RING VITON	14-15-140	2 430 210 082	Ø 11x3
1	O-RING VITON	14-15-353	-	Ø 20x1,8
1	O-RING VITON	14-15-137	2 430 210 081	Ø 21x3
1	O-RING VITON	14-15-216	F 00H N37 810	Ø 36x2,6
1	O-RING VITON	14-15-177	F 00H N37 621	Ø 37,7x2,62
2	GUARNIZIONI RETTANGOLARI	14-10-212	F 00H N37 008/1	27x35 sez. 1.6
1	RONDELLA RAME	02-11-002	2 430 105 049	7,5x15x1,5



TIPO-TYPE

CODICE OMS 11-23-662

GASKET KIT

n°	Descrizione	Cod. OMS	Rif. originale	Misure
1	O-RING VITON	14-15-140	2 430 210 082	Ø 11x3
1	O-RING VITON	14-15-353	-	Ø 20x1,8
1	O-RING VITON	14-15-137	2 430 210 081	Ø 21x3
1	O-RING VITON	14-15-228	-	Ø 47x2,6
1	O-RING VITON	14-15-355	-	Ø 44x2,6
2	GUARNIZIONI RETTANGOLARI	14-10-212	F 00H N37 008/1	27x35 sez. 1.6
1	RONDELLA RAME	14-05-291	X11-800-002-002Z	7,5x15x1,5



TIPO-TYPE



CODICE OMS 11-23-664

GASKET KIT



n°	Descrizione	Cod. OMS	Rif. originale	Misure
1	O-RING	14-15-327	-	Ø 31,47x1,78
1	O-RING	14-15-339	-	Ø 33,05x1,78
1	O-RING	14-15-355	-	Ø 34,65x1,78
1	O-RING	-	-	Ø 34,5x2,6

TIPO-TYPE

CODICE OMS 11-23-668

GASKET KIT



n°	Descrizione	Cod. OMS	Rif. originale	Misure
1	O-RING	14-10-149	-	Ø 3,5x1,8
1	O-RING	14-15-226	-	Ø 18x1,5
1	ANELLO PTFE	-	-	Ø 3,8x6,5x1,7

TIPO-TYPE



CODICE OMS 11-23-670

ADATTABILE A :
0 445 110 ***
 008/036/044/057
 059/064/076/101
 126/290



TIPO-TYPE

CODICE OMS 11-23-671

ADATTABILE A :
0 445 110 ***
 028/029/030/031



TIPO-TYPE

CODICE OMS 11-23-672

ADATTABILE A :
0 445 110 ***
 047/048/049/130/266



TIPO-TYPE

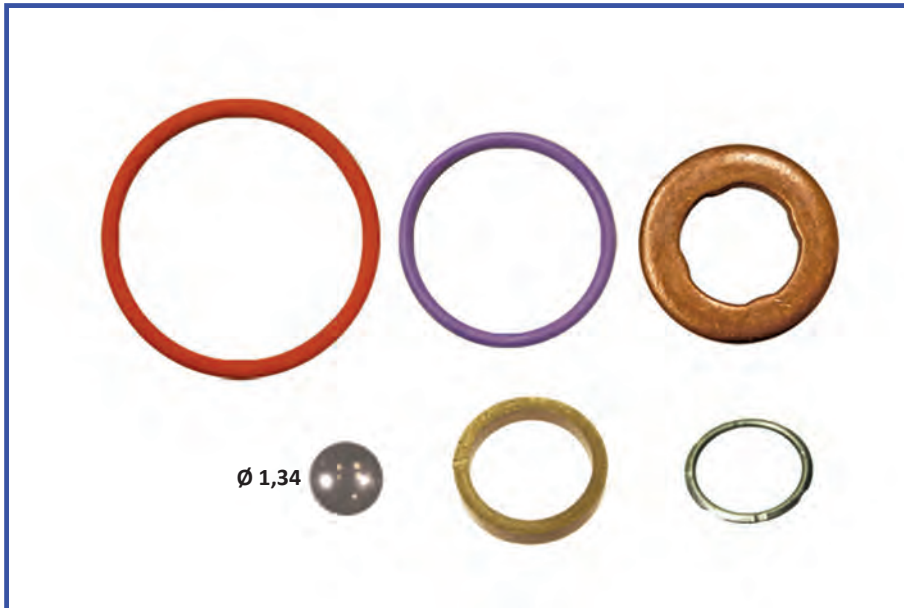

CODICE OMS 11-23-673

ADATTABILE A :
0 445 110 ***
065/066/113/114

TIPO-TYPE



CODICE OMS 11-23-674

ADATTABILE A :
0 445 110 ***
068/081/111/112
119/159/165

TIPO-TYPE



CODICE OMS 11-23-675

ADATTABILE A :
0 445 110 ***
075/077/078/135
217/218/251/286

TIPO-TYPE



CODICE OMS 11-23-676

ADATTABILE A :
0 445 110 ***
 091/092/185/186
 279/283/306



TIPO-TYPE

CODICE OMS 11-23-677

ADATTABILE A :
0 445 110 ***
 110/231



TIPO-TYPE

CODICE OMS 11-23-678

ADATTABILE A :
0 445 110 ***
 131/149/080/122



TIPO-TYPE



CODICE OMS 11-23-679

ADATTABILE A :
0 445 110 ***
136/188/239/249
250/259

TIPO-TYPE



CODICE OMS 11-23-680

ADATTABILE A :
0 445 110 ***
209/212/216/219

TIPO-TYPE



CODICE OMS 11-23-681

ADATTABILE A :
0 445 110 ***
213/243/244/274
281/293/297/299
300/304/305/308
311/312/327/333
348/362/363/370
375/420/454

TIPO-TYPE



CODICE OMS 11-23-682

ADATTABILE A :

0 445 110 ***
222/223

TIPO-TYPE

CODICE OMS 11-23-683

ADATTABILE A :

0 445 110 ***
232/233

TIPO-TYPE

CODICE OMS 11-23-684

ADATTABILE A :

0 445 110 ***
237/238/247/248
261/273/276/280
289/302/303/309
313/322/328/331
377/378/401

TIPO-TYPE



CODICE OMS 11-23-685

ADATTABILE A :
0 445 110 ***
252/253/257/258
269/287/291/298
301/316/318/321
345/354/376/387
388/424

TIPO-TYPE



CODICE OMS 11-23-686

ADATTABILE A :
0 445 110 ***
255/256

TIPO-TYPE



CODICE OMS 11-23-687

ADATTABILE A :
0 445 110 ***
260/310/317/335
343/512

TIPO-TYPE



CODICE OMS 11-23-688

ADATTABILE A :
0 445 110 265



TIPO-TYPE

CODICE OMS 11-23-689

ADATTABILE A :
0 445 110 ***
274/275/277/278



TIPO-TYPE

CODICE OMS 11-23-690

ADATTABILE A :
0 445 110 ***
284/168/169/315



TIPO-TYPE



ADATTABILE A / SUITABLE TO : 0 445 110 ***

11-23-***



CODICE OMS 11-23-691

ADATTABILE A :
0 445 110 342

TIPO-TYPE



ceramic
Ø 1,50

CODICE OMS 11-23-692

ADATTABILE A :
0 445 110 ***
355/397

TIPO-TYPE PDE 100



11-23-***



CODICE OMS 11-23-693

GASKET KIT

APPLICAZIONE:
C/RAIL-CP1H
PUMP 0445 010 157

TIPO-TYPE

CODICE OMS 11-23-700

GASKET KIT

APPLICAZIONE:
C/R-CP3 VOLVO
PUMP 0 445 010 043

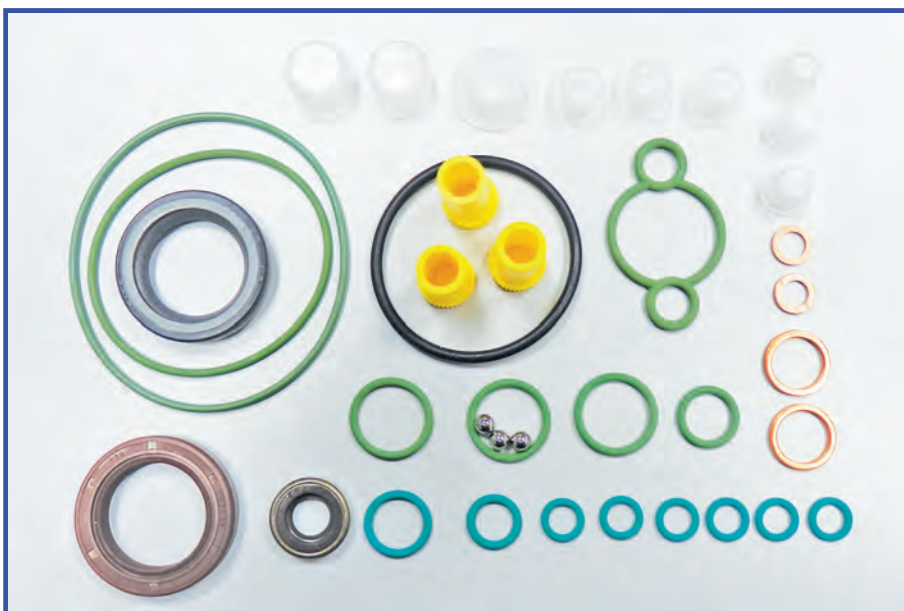

TIPO-TYPE

CODICE OMS 11-23-701

GASKET KIT

APPLICAZIONE:
C/R-CP3 AUDI A8
PUMP 0 445 010 082



TIPO-TYPE

CODICE OMS 11-23-702

GASKET KIT

APPLICAZIONE:
C/R-CP3 HYUNDAI
PUMP 0 445 010 101=052



TIPO-TYPE



CODICE OMS 11-23-703

GASKET KIT

APPLICAZIONE:
SIEMENS C/R FORD
PUMP 5WS40273

TIPO-TYPE

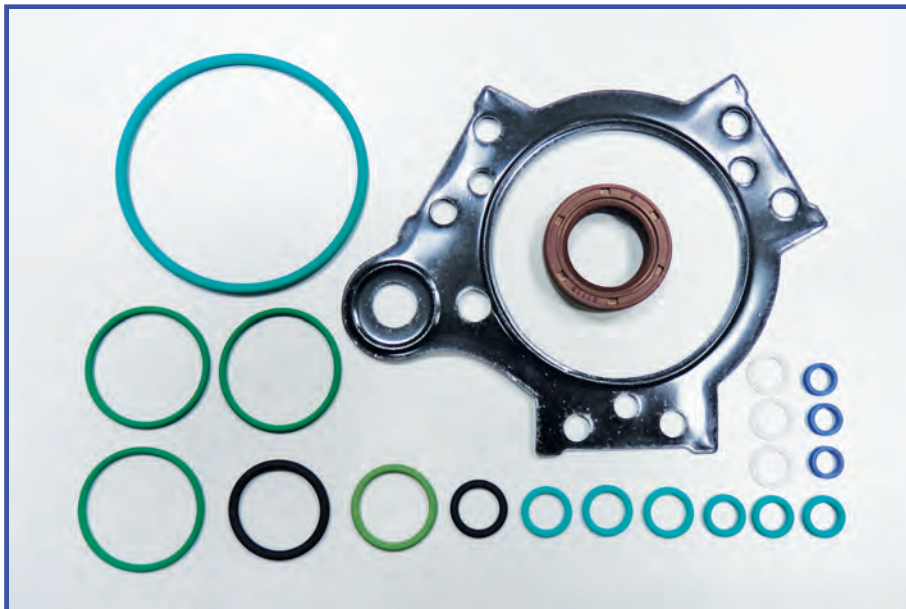

CODICE OMS 11-23-704

GASKET KIT

APPLICAZIONE:
SIEMENS C/R R/ROVER
PUMP 5WS40157

TIPO-TYPE



CODICE OMS 11-23-705

GASKET KIT

APPLICAZIONE:
EUI-CATERPILLAR
NEDO OR2921

TIPO-TYPE



CODICE OMS 11-23-709

GASKET KIT

APPLICAZIONE:
C/R-RENAULT-NISSAN
PUMP 0 445 010 099

TIPO-TYPE



CODICE OMS 11-23-710

GASKET KIT

APPLICAZIONE:
KOMATSU7CUMMINS
PUMP 0 445 020 043

TIPO-TYPE



CODICE OMS 11-23-711

GASKET KIT

APPLICAZIONE:
CP1 H RENAULT 2.0
PUMP 0 445 010 170

TIPO-TYPE

CODICE OMS 11-23-712

GASKET KIT

APPLICAZIONE:
C/R SIEMENS-FORD



TIPO-TYPE

CODICE OMS 11-23-713

GASKET KIT

APPLICAZIONE:
C/R PUMP CP4
PUMP 0 445 010 507



TIPO-TYPE

CODICE OMS 11-23-714

GASKET KIT

Bh F 00H N37 928
+
Bh F 00V X99 999

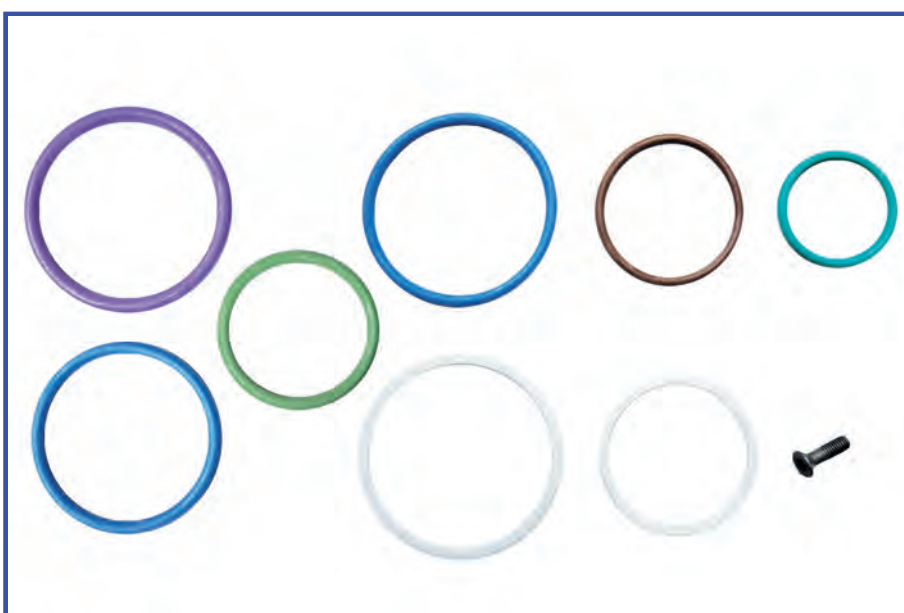

TIPO-TYPE



CODICE OMS 11-23-716

GASKET KIT

TIPO-TYPE DAF XF/CF

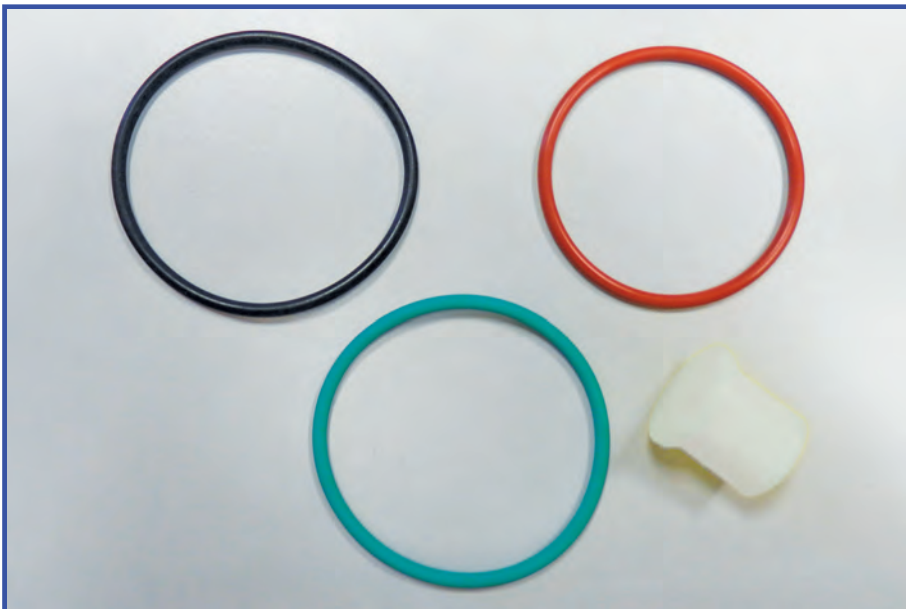

CODICE OMS 11-23-717

GASKET KIT

TIPO-TYPE DAF XF/CF

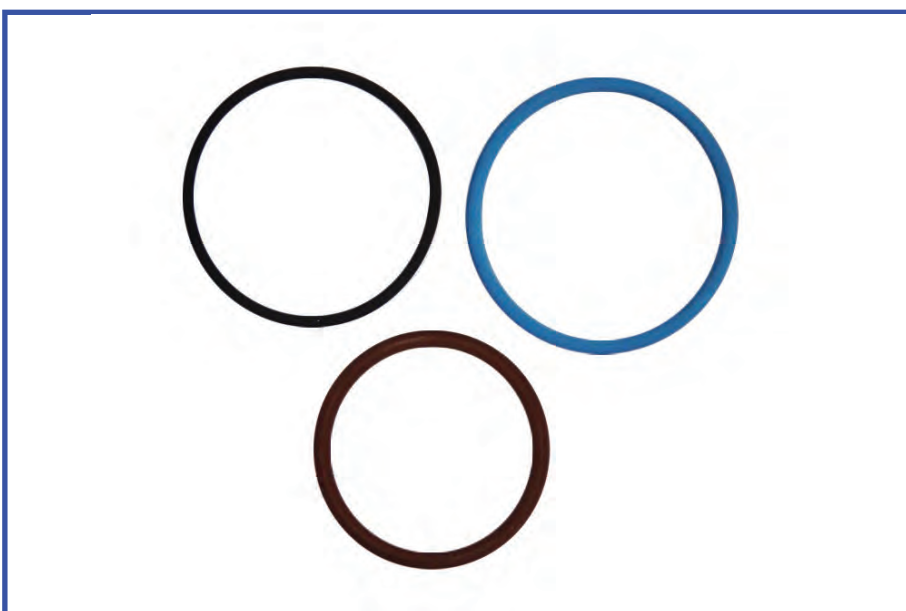

CODICE OMS 11-23-718

Bh F 00H 4S0 011

TIPO-TYPE PDE 100-UIN3



CODICE OMS 11-23-719

L/ROVER
DEFENDER+DISCOVERY



TIPO-TYPE EUI

CODICE OMS 11-23-720

CUMMINS EUI



TIPO-TYPE CELECT L10

CODICE OMS 11-23-721

CUMMINS EUI



TIPO-TYPE CELECT N14



11-23-***

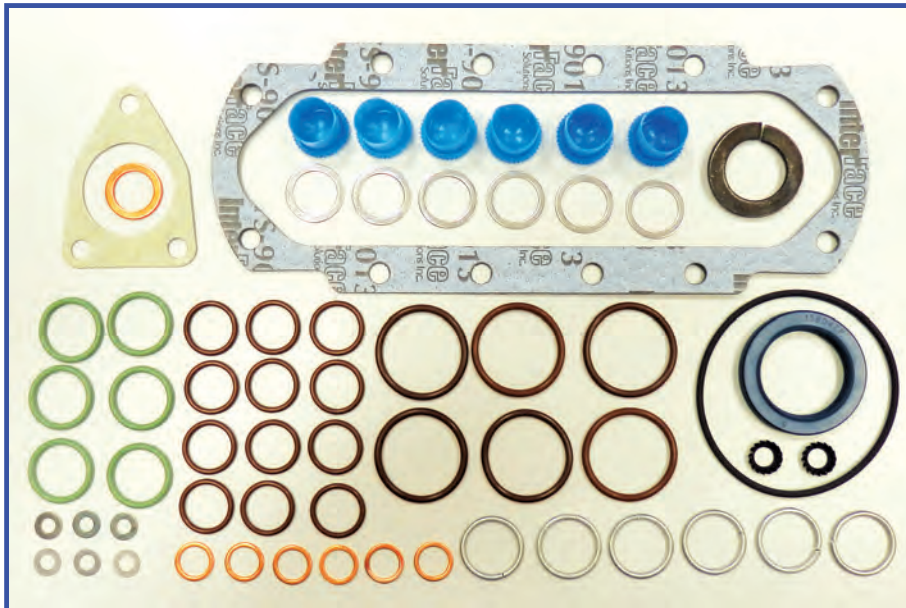

CODICE OMS 11-23-722

9 401 087 173/2
PER POMPA A INIEZIONE
PEP6P 110A 920/4 LS322
PER SAAB SCANIA

versione Brasile

TIPO-TYPE EUI



CODICE OMS 11-23-735

GASKET KIT
PER POMPA/FOR PUMP
0 445 010 611

TIPO-TYPE C/R CP4

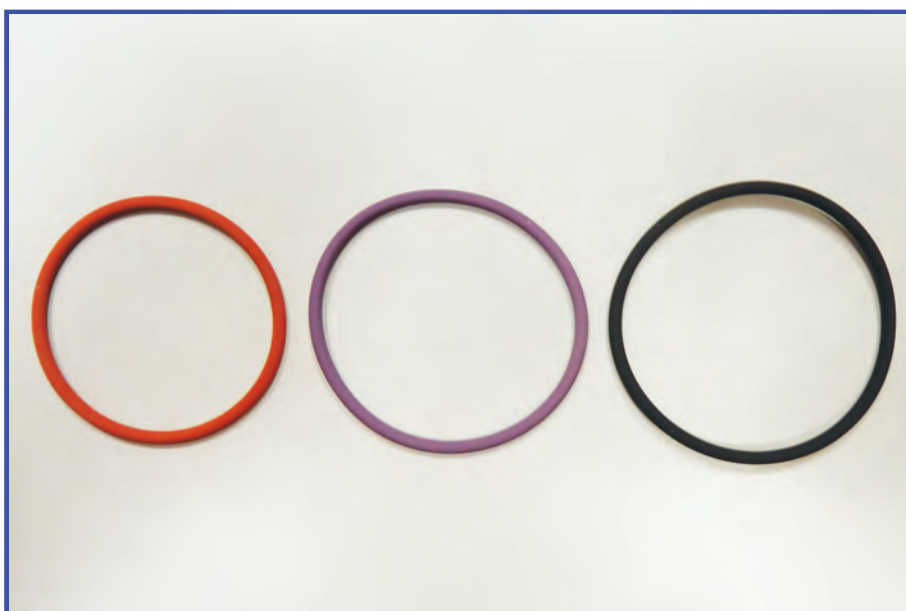

CODICE OMS 11-23-736

GASKET KIT
Delphi BEBU5A00000
EUP

TIPO-TYPE DAF TRUCK XF105



CODICE OMS 11-23-140

GASKET KIT



TIPO-TYPE PDE 90

CODICE OMS 11-23-141

GASKET KIT

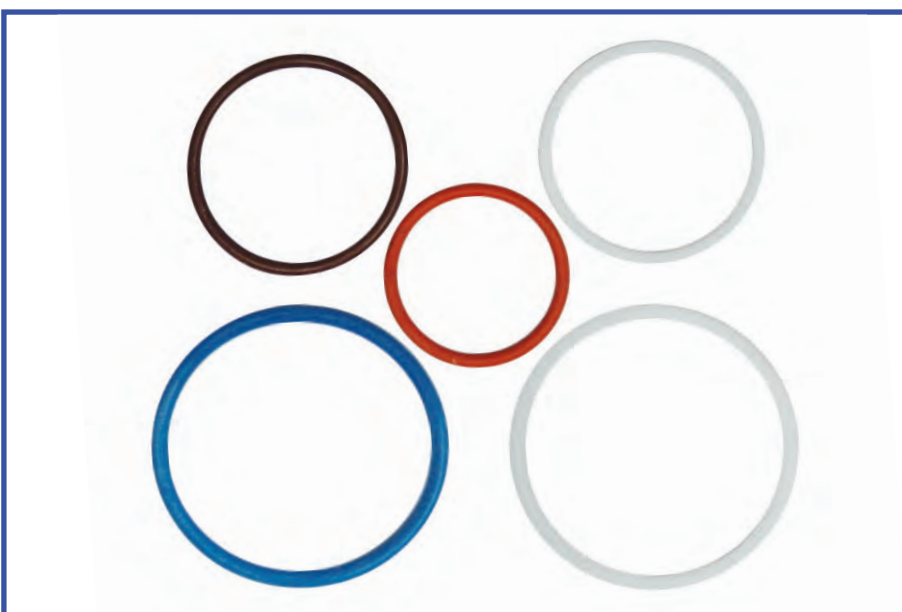

TIPO-TYPE PDE 90

CODICE OMS 11-23-182/3

KIT TENUTA

Con 4 paraoli



TIPO-TYPE

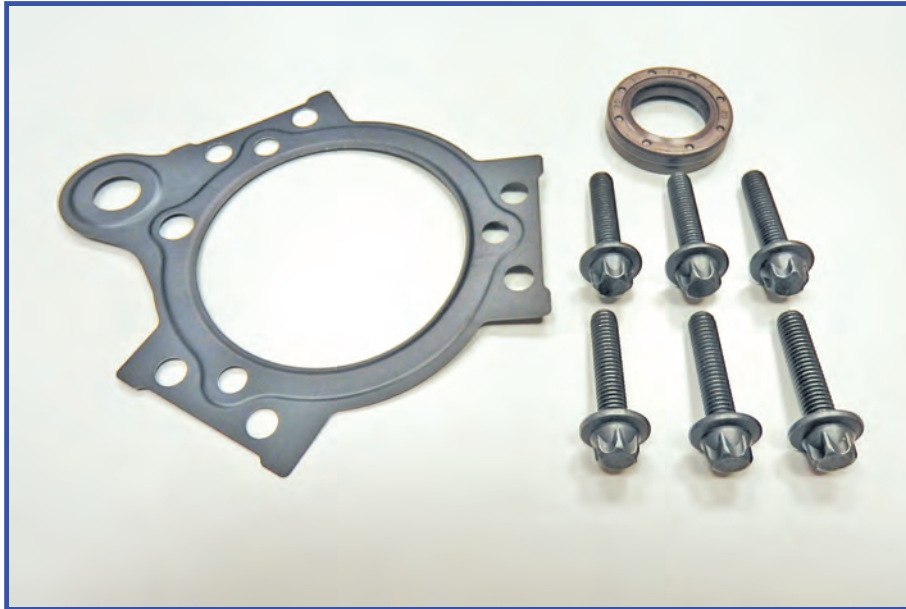

CODICE OMS 11-23-737

GASKET KIT

COD. A2C59512213

APPLICAZIONE:
5WS40157

Con paraolio 7,3x31x20

TIPO-TYPE



CODICE OMS 11-23-738

GASKET KIT

COD. X39-800-300-019Z

APPLICAZIONE:
5WS40008

Con paraolio 7,3x31x20

TIPO-TYPE



CODICE OMS 11-23-739

KIT SIEMENS
PER INIETTORE POMPA

COD. 03G 198 051 D

COD. COMPRENDE ANCHE:
03G 198 051 C

TIPO-TYPE PDE SIEMENS

CODICE OMS 11-23-740

KIT INIETTORE
COMMON-RAIL
con 2 O-RING IN NBR

ADATTABILE A :

0 445 120 ***

028/006/007/008/012
013/016/017/029/035
037/038/043/044/070
077/079/089/094/097
112/125/133/140/144
212/236/237/240/241
272/273



TIPO-TYPE

CODICE OMS 11-23-741

KIT INIETTORE
COMMON-RAIL
con 2 O-RING IN VITON

ADATTABILE A :

0 445 120 ***

028/006/007/008/012
013/016/017/029/035
037/038/043/044/070
077/079/089/094/097
112/125/133/140/144
212/236/237/240/241
272/273



TIPO-TYPE

CODICE OMS 11-23-777

KIT COMPLETO
PER DETROIT DIESEL 50/60
CON VITI, MOLLE E
SEDE MOLLA

SUITABILE

DETROIT DIESEL 50/60

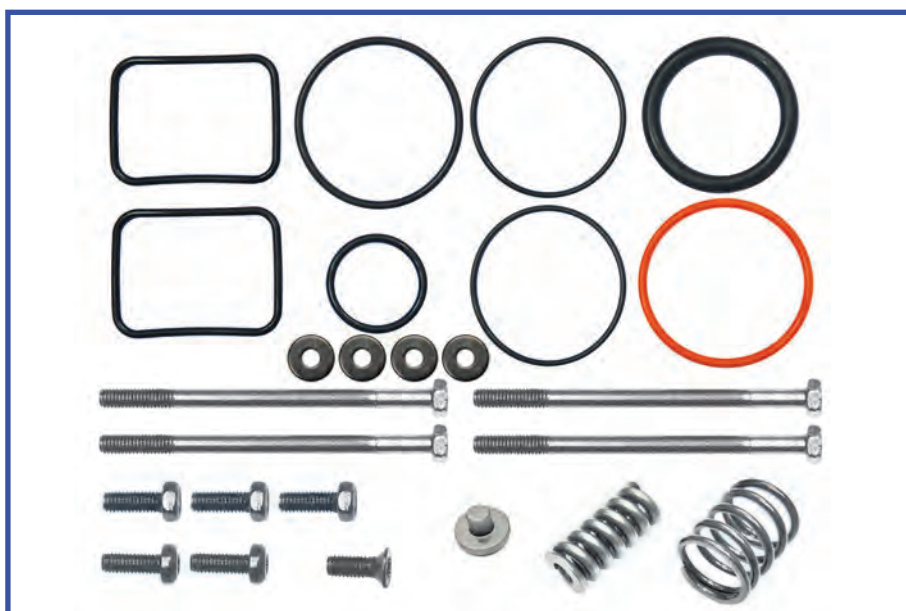

TIPO-TYPE



11-23-***



CODICE OMS 11-23-781

KIT VALVOLE
PER POWERSTROKE 6.0/4.5
CON SPESSORE E SFERA

SUITABLE
POWERSTROKE 6.0/4.5

TIPO-TYPE



CODICE OMS 11-23-782

KIT COMPLETO
PER POWERSTROKE 6.0/4.5
CON
POMPANTE, DISTANZIALE, ECC

SUITABLE
POWERSTROKE 6.0/4.5

TIPO-TYPE

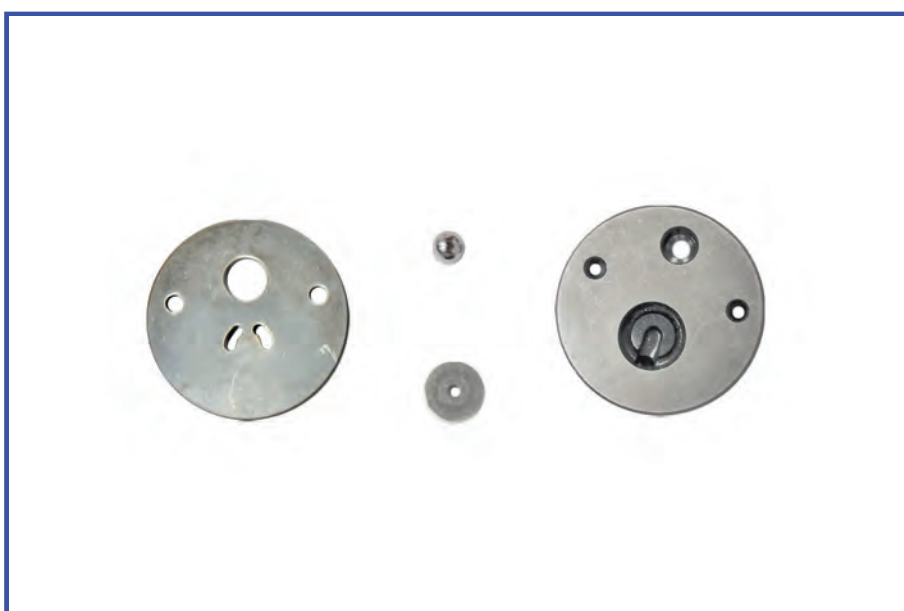

CODICE OMS 11-23-800

KIT VALVOLE
PER POWERSTROKE 7.3
CON SPESSORE E SFERA

SUITABLE
POWERSTROKE 7.3

TIPO-TYPE



CODICE OMS 11-23-801

KIT
PER POWERSTROKE 7.3
CON DISTANZIALE, MOLLA,
SPESSORE E SPINA

SUTABRE

POWERSTROKE 7.3

TIPO-TYPE



CODICE OMS 11-23-821

KIT VITI
PER CATERPILLAR C 9 HEUI

SUTABRE

CATERPILLAR C 9 HEUI

TIPO-TYPE



CODICE OMS 11-23-822

KIT STANTUFFO
PER CATERPILLAR C 9 HEUI
CON DISTANZIALE

SUTABRE

CATERPILLAR C 9 HEUI

TIPO-TYPE





11-23-***



CODICE OMS 11-23-823

KIT VALVOLE
PER CATERPILLAR C 9 HEUI
CON SPESSORE E SFERA

SUTABLE
CATERPILLAR C 9 HEUI

TIPO-TYPE



CODICE OMS 11-23-829

KIT VITI
PER CATERPILLAR 3406 E

SUTABLE
CATERPILLAR 3406 E

TIPO-TYPE



CODICE OMS 11-23-830

KIT ESTERNO
PER CATERPILLAR 3406 E
CON MOLLA, MOLLETTINA
E SFERA

SUTABLE
CATERPILLAR 3406 E

TIPO-TYPE



CODICE OMS 11-23-831

KIT VALVOLE
PER CATERPILLAR 3126 HEUI
CON SPESSORE E SFERA

SUITABLE
CATERPILLAR 3126 HEUI

TIPO-TYPE



CODICE OMS 11-23-934

KIT VITI
PER CATERPILLAR 3500

SUITABLE
CATERPILLAR 3500

TIPO-TYPE



CODICE OMS 11-23-935

KIT
APPLICAZIONE: CP1 H3
PUMPS: 0 445 010 181
COMPLETO DI VITI

TIPO-TYPE





11-23-***



CODICE OMS 11-23-936

KIT UNIVERSALE
APPLICAZIONE: CP1, CP3
PUMPS: 0 445 020 ***
018/023/053/208

TIPO-TYPE



CODICE OMS 11-23-941

KIT INIETTORE DAF

TIPO-TYPE



CODICE OMS 11-23-944

GASKET KIT

TIPO-TYPE



CODICE OMS 11-23-955

KIT
 APPLICAZIONE: CP1 H3
 PUMPS: 0 445 010 181



TIPO-TYPE

CODICE OMS 11-23-956

KIT
 PER DETROIT DIESEL 50/60
 CON VITI, MOLLE E
 SEDE MOLLA



SUTTABLE
 DETROIT DIESEL 50/60

TIPO-TYPE

CODICE OMS 11-23-957

KIT PISTONE
 PER CUMMINS L10, M11, N14



SUTTABLE
 CUMMINS L10,M11,N14

TIPO-TYPE





CODICE OMS 11-24-032

IVECO STRALIS
430=480=530

IVECO EUROCARGO
280=330=350=400

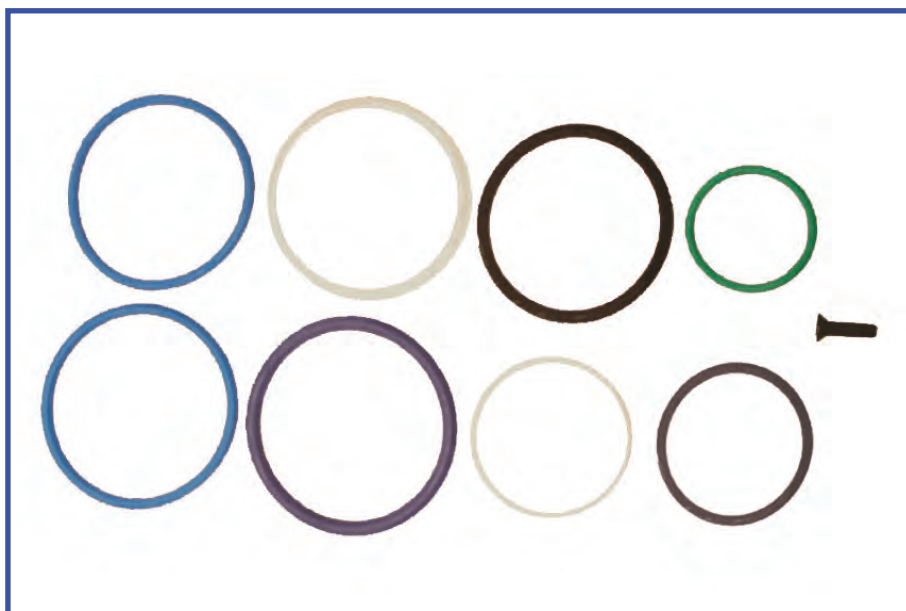
F 00H N37 928
+
F 00V X99 995



TIPO-TYPE

CODICE OMS 05-07-001

COD. N°2 Boccole
Bh 1 420 301 002

COD. N°1 Nottolino snodato
Bh 2 422 120 052

COD. N°1 Alberino di comando
Bh 1 423 002 080

COD. N°2 Paraolio
Bh 1 420 283 001

COD. N°2 Spine
Bh 2 917 540 081



TIPO-TYPE

CODICE OMS 05-07-002

COD. N°2 Boccole
Bh 1 420 301 002

COD. N°1 Nottolino snodato
Bh 2 422 120 052

COD. N°1 Alberino di comando
Bh 1 423 002 080

COD. N°2 Spine
Bh 2 917 540 081

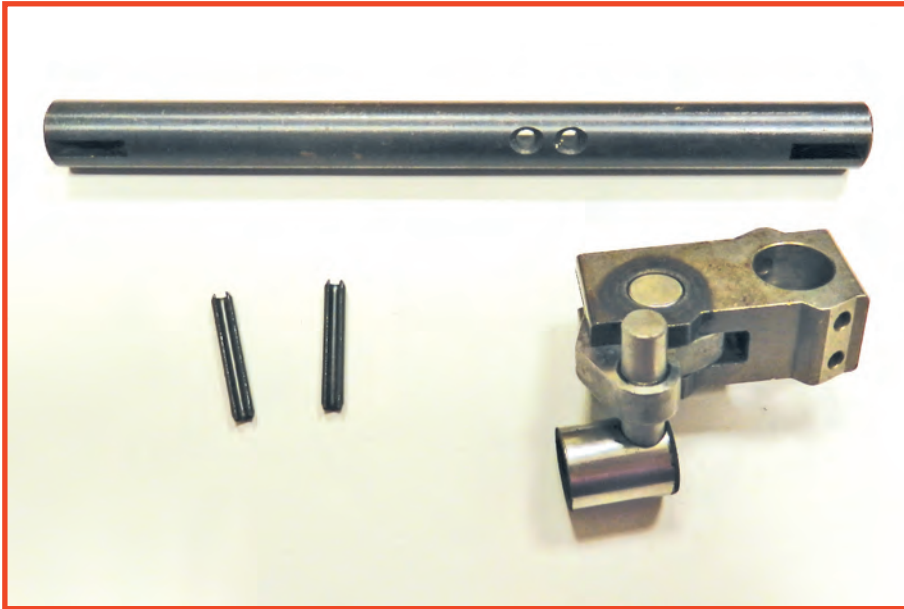

TIPO-TYPE

**CODICE OMS 05-07-003**

COD. N°1 Nottolino snodato
Bh 2 422 120 052

COD. N°1 Alberino di comando
Bh 1 423 002 080

COD. N°2 Spine
Bh 2 917 540 081

COD.

TIPO-TYPE

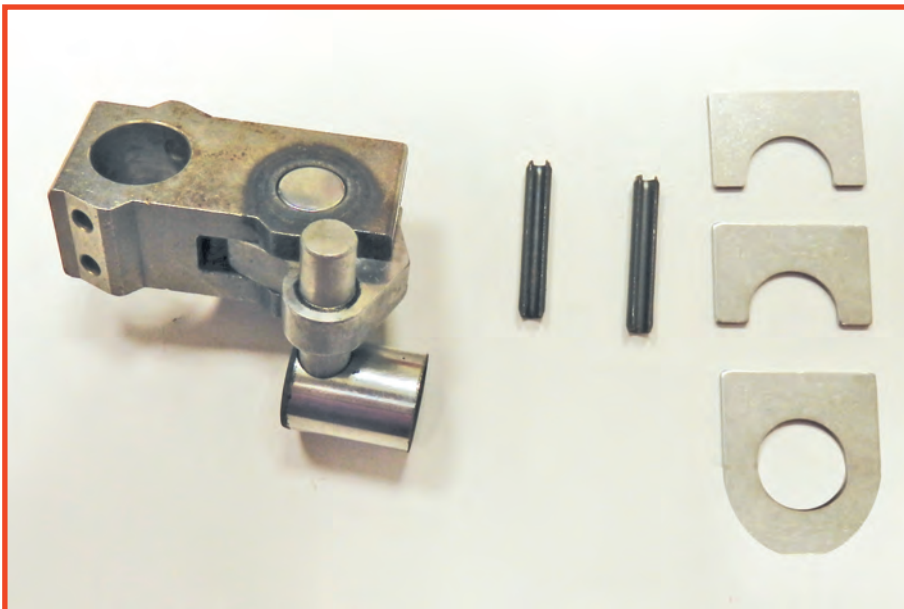
**CODICE OMS 05-07-004**

COD. N°1 Nottolino snodato
Bh 2 422 120 052

COD. N°1 Rondella
Bh 1 411 030 000

COD. N°2 Spine
Bh 2 917 540 081

COD. N°2 Rondelle
Bh 1 421 030 004

TIPO-TYPE

**CODICE OMS 05-07-005**

COD. N°2 Boccole
Bh 1 420 301 006

COD. N°1 Nottolino snodato
Bh 2 422 120 064

COD. N°1 Alberino di comando
Bh 1 423 061 004

COD. N°2 Spine
Bh 2 917 540 081

TIPO-TYPE

**CODICE OMS 05-07-006**

COD.	N°2 Boccole Bh 1 420 301 002
COD.	N°1 Nottolino snodato Bh 2 422 120 058
COD.	N°1 Alberino di comando Bh 1 423 002 080
COD.	N°2 Spine Bh 2 917 540 081

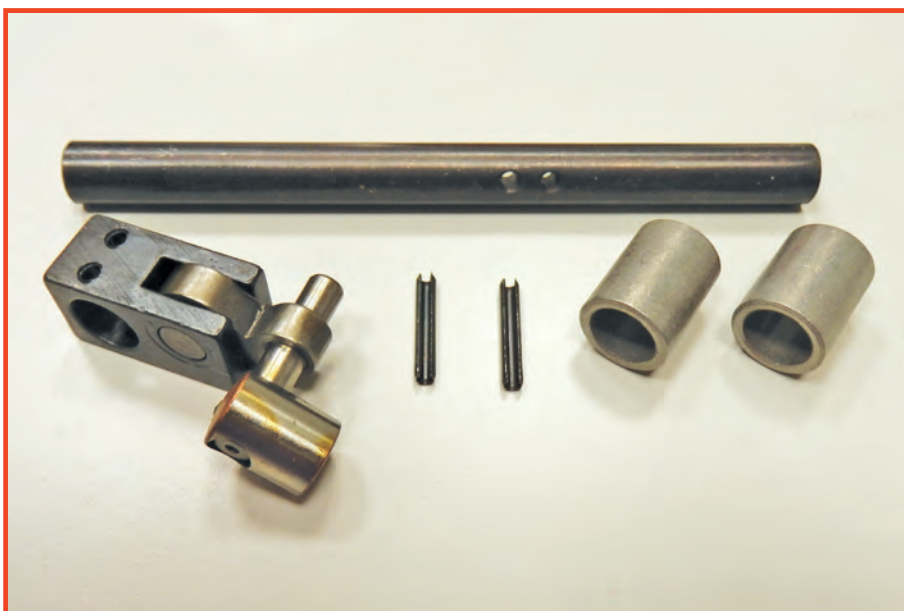

TIPO-TYPE

CODICE OMS 05-07-007

COD.	N°2 Boccole Bh 1 420 301 006
COD.	N°1 Nottolino snodato Bh 2 422 120 064 OLD CODE Bh 2 422 120 093 NEW CODE
COD.	N°1 Alberino di comando Bh 1 423 061 004
COD.	N°2 Paraolio Bh 1 420 283 006
COD.	N°2 Spine Bh 2 917 540 081

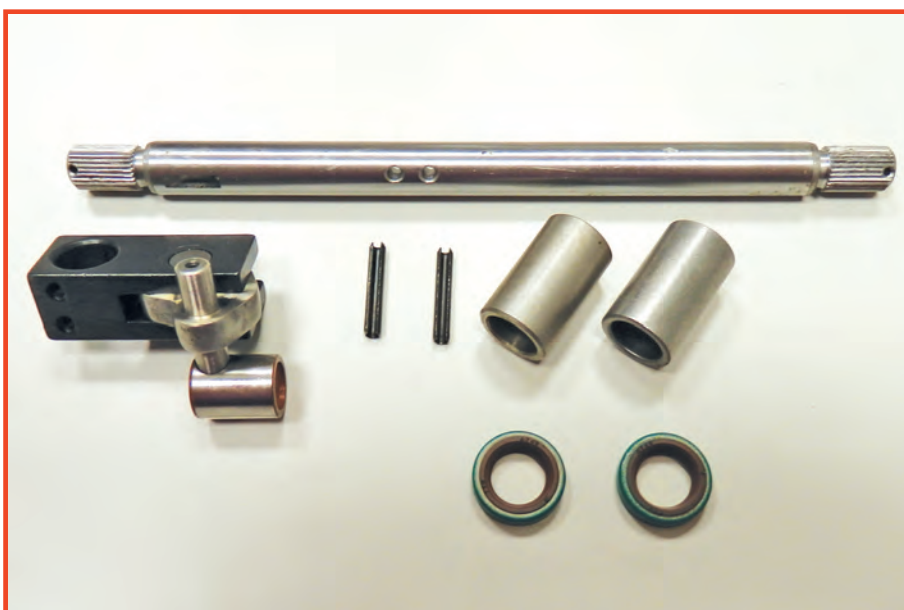

TIPO-TYPE

CODICE OMS 05-07-008

COD.	N°2 Boccole Bh 1 420 301 002
COD.	N°1 Nottolino snodato Bh 2 422 120 052 OLD CODE Bh 2 422 120 091 OLD CODE Bh 2 422 120 096 NEW CODE
COD.	N°1 Alberino di comando Bh 1 423 061 004
COD.	N°2 Spine Bh 2 917 540 081

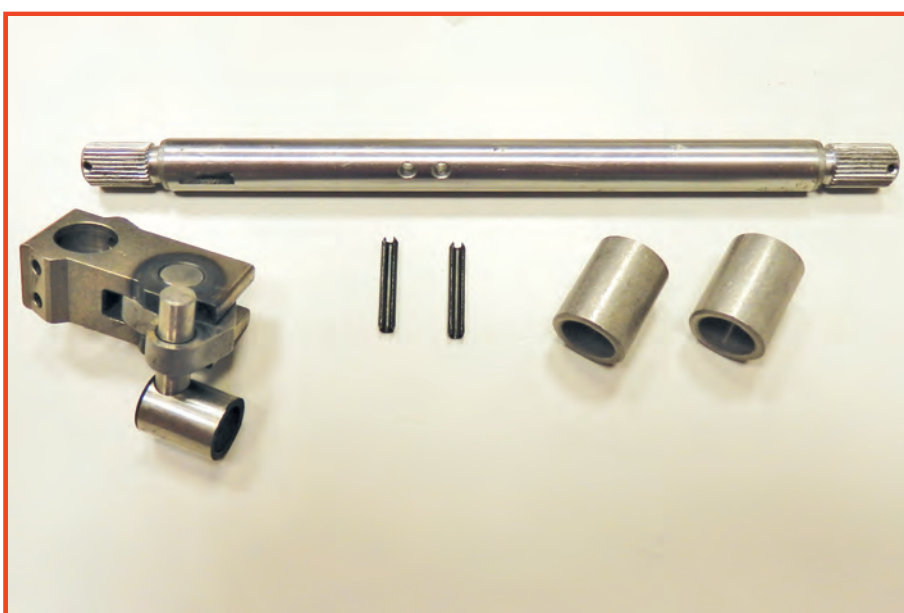

TIPO-TYPE

**CODICE OMS 05-07-009**

COD. N°2 Boccole
Bh 1 420 328 005

COD. N°1 Alberino di comando
Bh 1 423 002 030

COD. N°1 Chiavetta
Bh 1 900 023 002

COD. N°2 Coppiglie
1,8x15 mm

COD. N°2 Rondelle
8,2x16x0,25

COD. N°2 O-ring
1 900 210 105

TIPO-TYPE

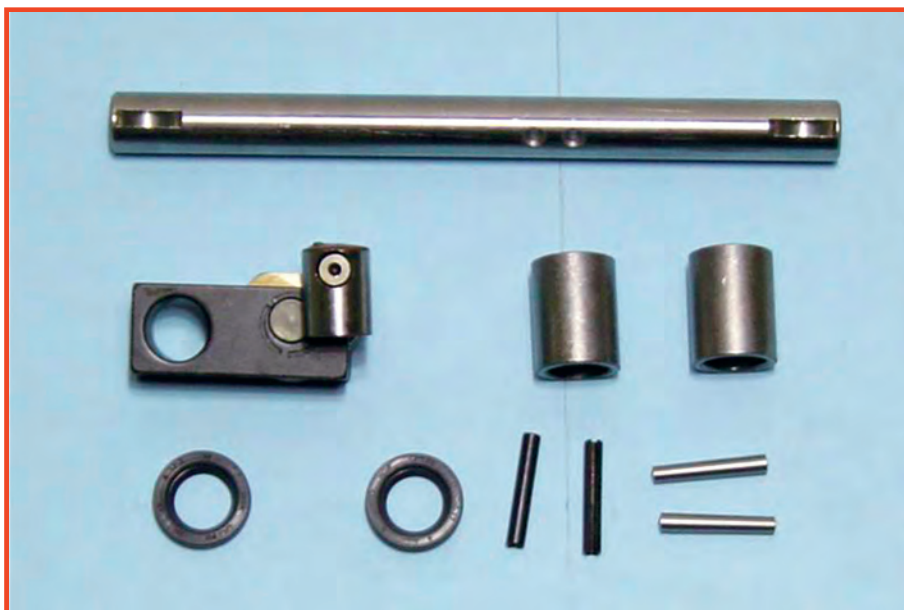
**CODICE OMS 05-07-010**

COD. N°2 Boccole
Bh 1 420 301 006

COD. N°1 Nottolino snodato
Bh 2 422 120 058

COD. N°1 Alberino di comando
Bh 1 423 002 080

COD. N°2 Paraolio
1 420 283 001

COD. N°2 Spine coniche
Bh 2 917 540 081

COD. N°2 Spine
Bh 2 917 540 081

TIPO-TYPE

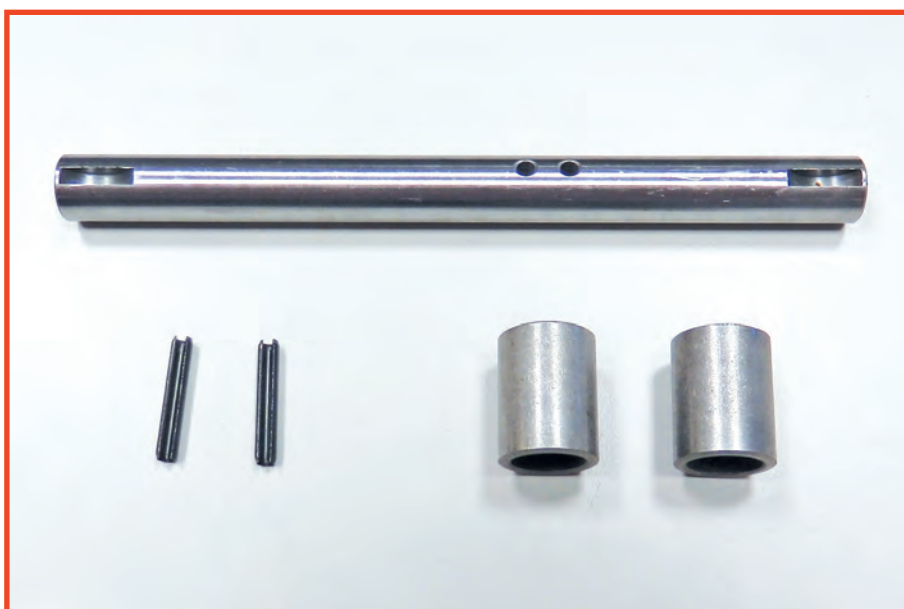
**CODICE OMS 05-07-011**

COD. N°2 Boccole
Bh 1 420 301 002

COD. N°1 Alberino di comando
Bh 1 423 002 080

COD. N°2 Spine coniche
Bh 2 917 540 081

TIPO-TYPE

CODICE OMS 05-07-012

COD. Bh 2 427 010 002

N°2 Boccole

COD. Bh 2 420 328 031

N°1 Alberino di comando

COD. Bh 2 423 105 030

N°2 Rondelle

COD. Bh 1 420 100 602

N°2 O-ring

COD. Bh 1 900 210 105

N°2 Scodellini

COD. Bh 2 420 500 038



TIPO-TYPE

CODICE OMS 05-07-013

COD. Bh 2 427 010 046

N°2 Boccole

COD. Bh 2 420 301 004

N°1 Alberino di comando

COD. Bh 2 423 061 004

N°1 Nottolino

COD. Bh 2 422 120 093



TIPO-TYPE

CODICE OMS 05-07-014

COD. Bh 2 427 010 045

N°2 Boccole

COD. Bh 2 420 301 004

N°1 Alberino di comando

COD. Bh 1 423 002 080

N°1 Nottolino snodato

Bh 2 422 120 052 OLD CODE

COD. Bh 2 422 120 093 NEW CODE

N°2 Spine

COD. Bh 2 423 202 001

N°1 Piastra intermedia

COD. Bh 1 421 030 004

N°2 Piastre intermedie

COD. Bh 1 411 030 000

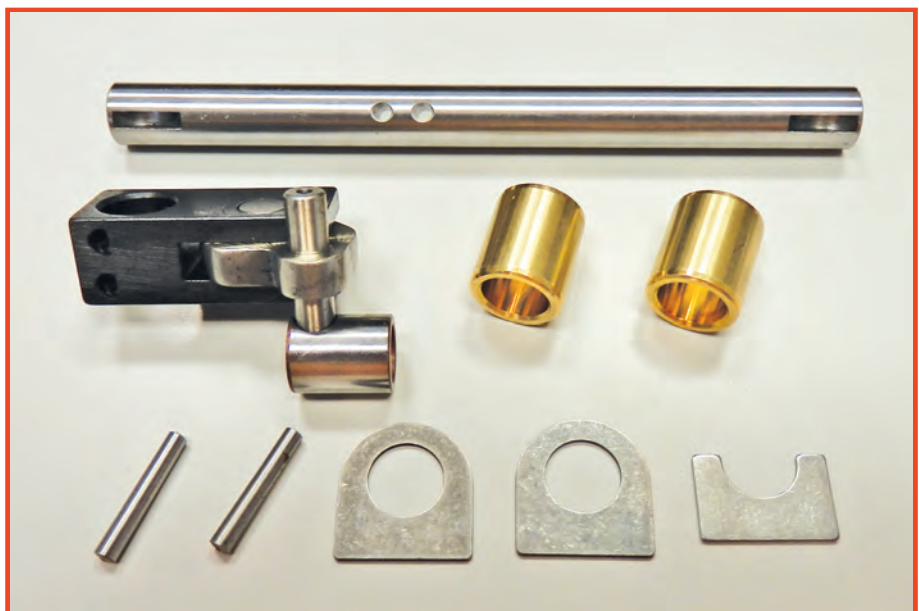

TIPO-TYPE

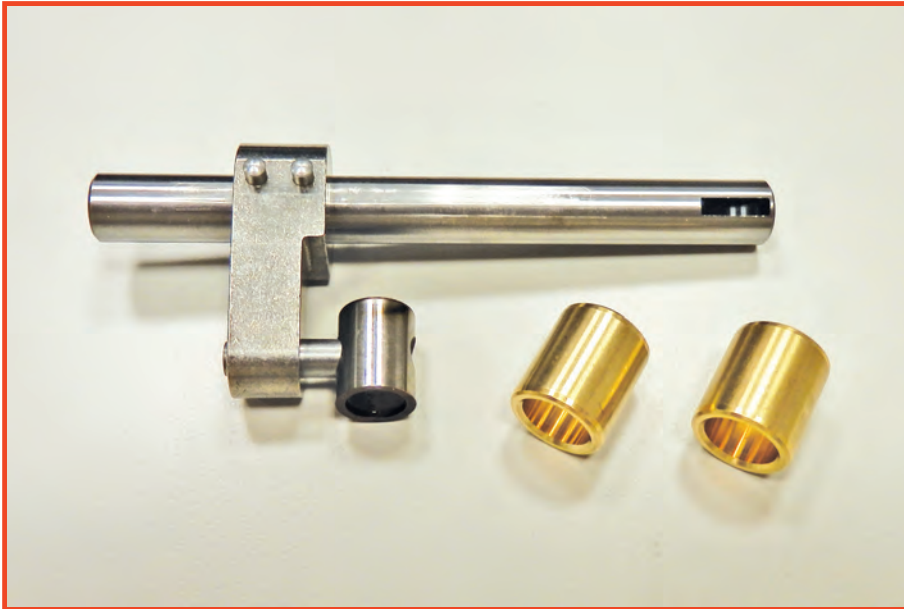
**CODICE OMS 05-07-015**

COD. Bh 2 427 010 044

COD. N°2 Boccole
Bh 2 420 301 004COD. N°1 Alberino di comando
Bh 1 423 002 084COD. N°1 Leva a braccio
Bh 2 422 001 024COD. N°2 Spine
Bh 2 423 202 001

TIPO-TYPE

**CODICE OMS 05-07-016**

COD. Bh 2 427 010 043

COD. N°2 Boccole
Bh 2 420 301 004COD. N°1 Alberino di comando
Bh 1 423 002 080COD. N°1 Leva a braccio
Bh 2 422 001 024COD. N°2 Spine
Bh 2 423 202 001

TIPO-TYPE

CODICE OMS 07-06-001

COD. Bh 2 447 010 035

COD.

COD.

COD.



TIPO-TYPE

CODICE OMS 07-06-002

COD. Bh 2 447 010 032

COD.

COD.

COD.



TIPO-TYPE

CODICE OMS 07-06-004

COD.

COD.

COD.

COD.



TIPO-TYPE



CODICE OMS 07-06-005

COD. Bh 2 447 010 017

COD. _____

COD. _____

COD. _____

TIPO-TYPE



CODICE OMS 07-06-006

COD. Bh 2 447 010 018

COD. _____

COD. _____

COD. _____

TIPO-TYPE

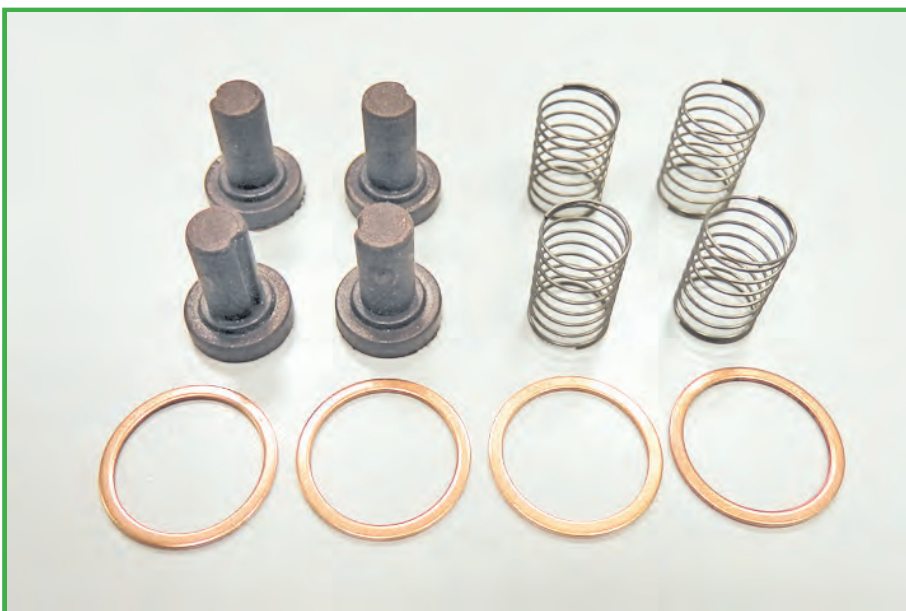

CODICE OMS 07-06-007

COD. Bh 2 447 010 019

COD. _____

COD. _____

COD. _____

TIPO-TYPE



CODICE OMS 07-06-008

COD. Bh 2 447 010 004/

COD.

COD.

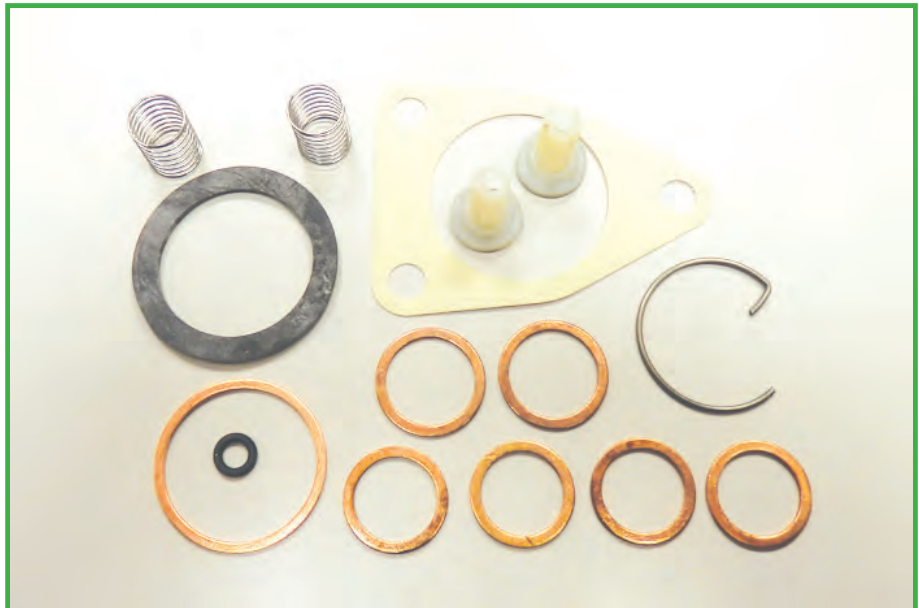
COD.



TIPO-TYPE Con guarnizione

CODICE OMS 07-06-008-1

COD. 9 441 080 020

COD.

COD.

COD.

Versione Brasile

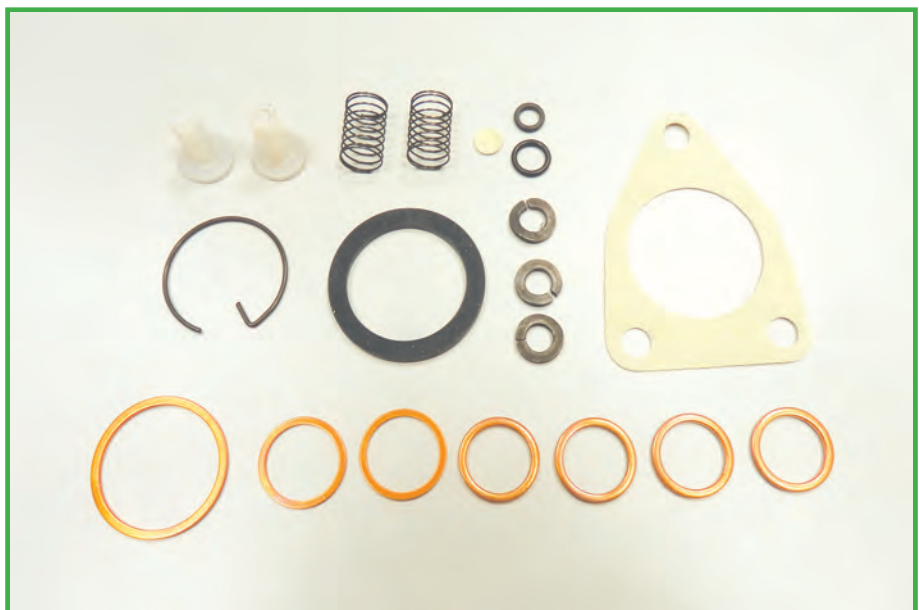

TIPO-TYPE

CODICE OMS 07-06-009

COD. Bh 2 447 010 011

COD.

COD.

COD.

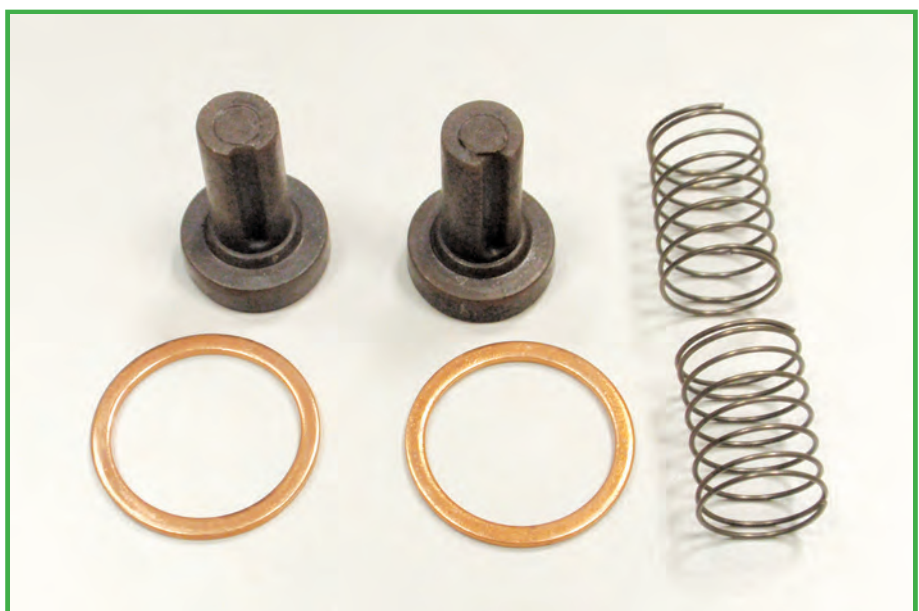

TIPO-TYPE



CODICE OMS 07-06-010

COD. Bh 2 447 010 016

COD.

COD.

COD.

TIPO-TYPE

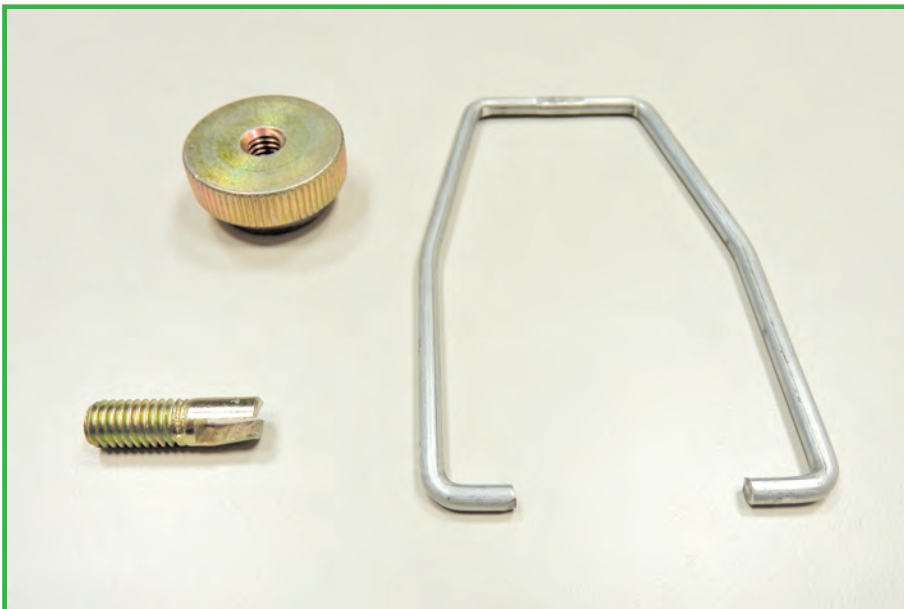

CODICE OMS 07-06-011

COD. Bh 2 447 010 027

COD. Bh 2 447 010 017

COD. Bh 2 447 010 003

COD.

TIPO-TYPE



CODICE OMS 07-06-012

COD. Bh 2 447 010 010

COD.

COD.

COD.

TIPO-TYPE



CODICE OMS 07-06-013

COD. Bh 2 447 010 012

COD.

COD.

COD.



TIPO-TYPE

CODICE OMS 07-06-014

COD.

COD.

COD.

COD.



TIPO-TYPE

CODICE OMS 07-06-015

COD.

COD.

COD.

COD.

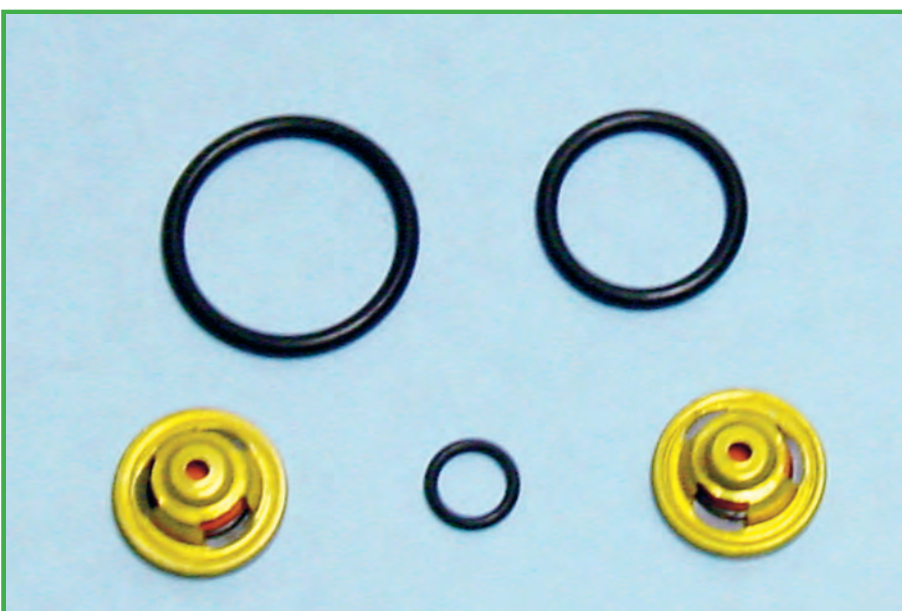

TIPO-TYPE

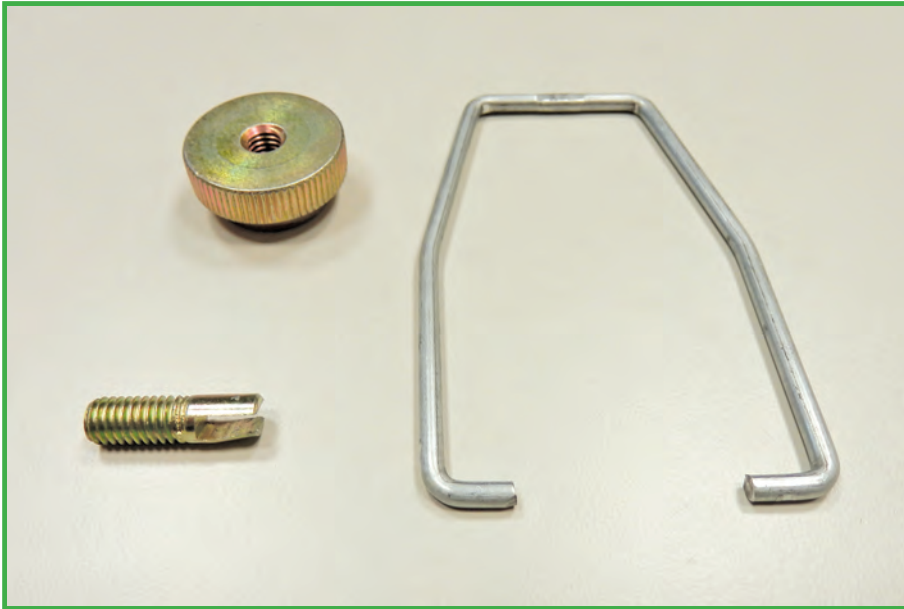

CODICE OMS 07-06-016

COD. KIT TURBOSTAR

COD.

COD.

COD.

TIPO-TYPE

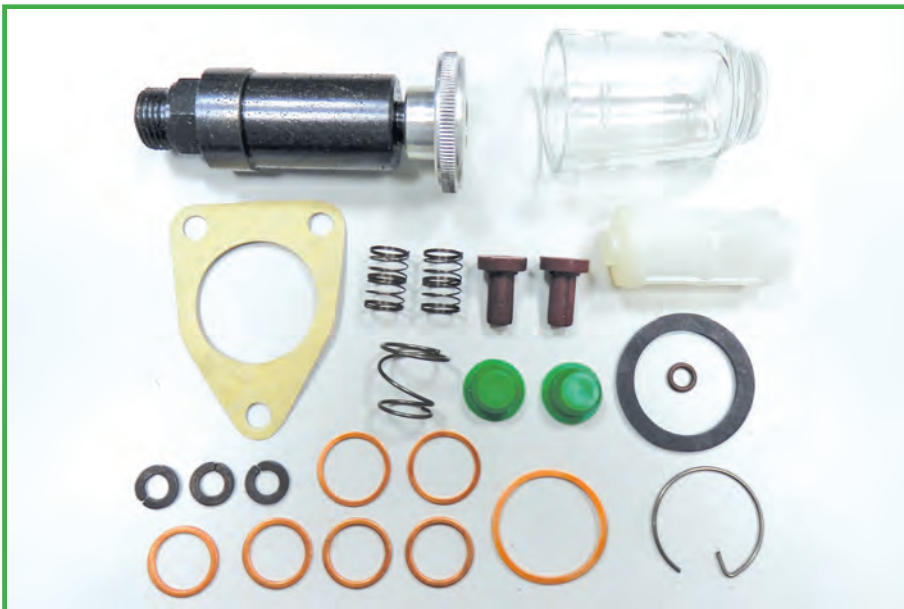

CODICE OMS 07-06-017

COD. 2 447 010 004

COD. DGK 301H

COD.

COD.

TIPO-TYPE

Per pompe FP - K
- KD - KE - KS/22
adescatore in ferro

CODICE OMS 07-06-018

COD.

COD.

COD.

COD.

TIPO-TYPE

Per pompe FP-K-KD-
KE-KS/22 adescatore
in plastica

CODICE OMS 07-06-019

COD. _____

COD. _____

COD. _____

COD. _____

TIPO-TYPE

 Per IVECO
 TURBOSTAR con
 filtro in acciaio

CODICE OMS 07-06-020

COD. _____

COD. _____

COD. _____

COD. _____

TIPO-TYPE

 Per pompe FP - K
 - KD - KE - KS/22
 adescatore in ferro

CODICE OMS 07-06-021

COD. _____

COD. _____

COD. _____

COD. _____

TIPO-TYPE

 Per .pompe FP-K-
 KD-KE-KS/22 adescatore in plastica



CODICE OMS 07-06-022

COD. _____

COD. _____

COD. _____

COD. _____

TIPO-TYPE Per IVECO
TURBOSTAR con
filtro in nylon



CODICE OMS 07-06-024

COD. Bh 2 447 010 004

COD. _____

COD. _____

COD. _____

TIPO-TYPE Senza guarnizione



CODICE OMS 07-06-025

COD. Denso 192290-0070

COD. _____

COD. _____

COD. _____

TIPO-TYPE Per FP/KD



CODICE OMS 07-06-026

COD. _____

COD. _____

COD. _____

COD. _____

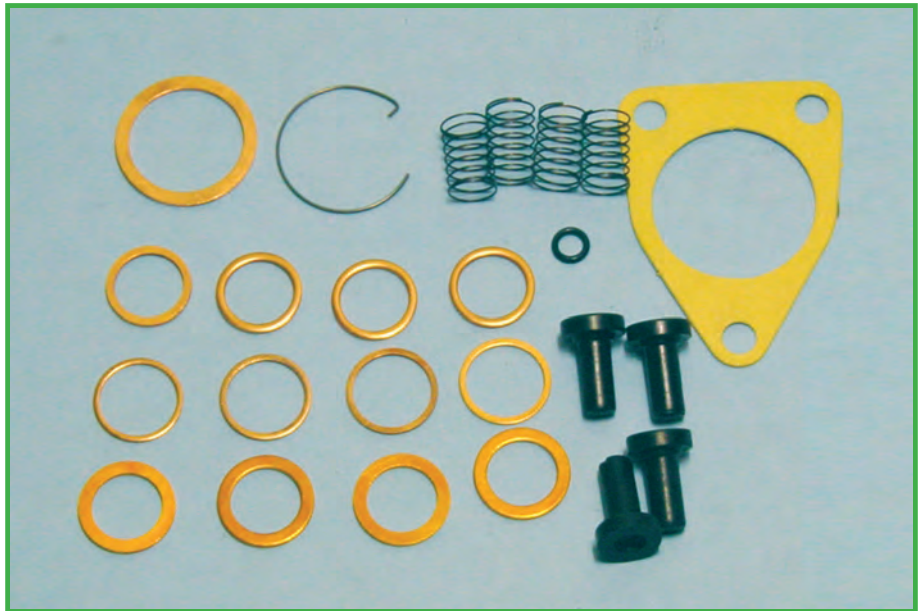

TIPO-TYPE DGK 301/4

CODICE OMS 07-06-027

COD. _____

COD. _____

COD. _____

COD. _____



TIPO-TYPE FP/K

CODICE OMS 07-06-028

COD. _____

COD. _____

COD. _____

COD. _____



TIPO-TYPE FP/KD..P



CODICE OMS 07-06-029

COD. _____

COD. _____

COD. _____

COD. _____

TIPO-TYPE FP/KD..P



CODICE OMS 07-06-030

COD. _____

COD. _____

COD. _____

COD. _____

TIPO-TYPE FP/K..A+P



CODICE OMS 07-06-031

COD. _____

COD. _____

COD. _____

COD. _____

TIPO-TYPE FP/K..A+P



CODICE OMS 07-06-032

COD. Bh 2 447 010 003

COD.

COD.

COD.

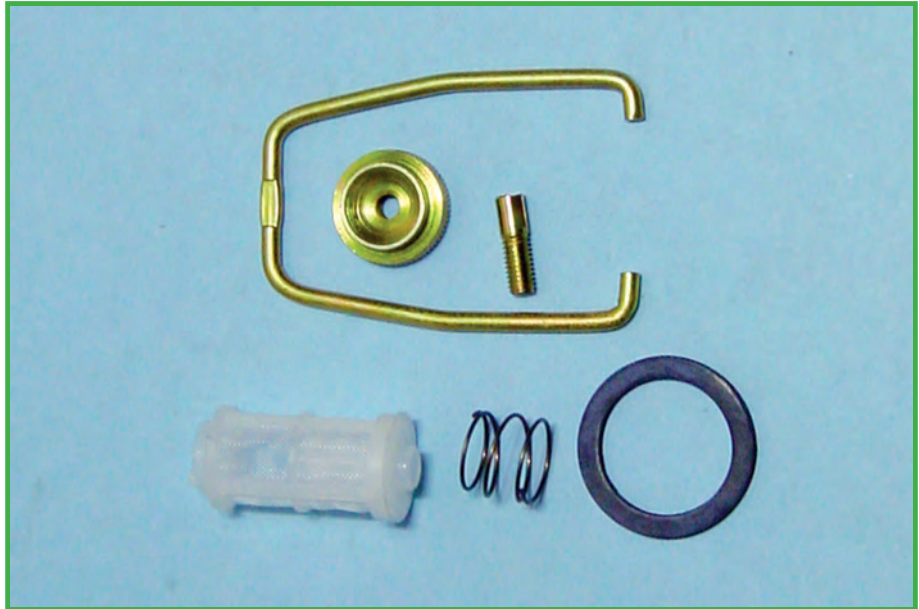

TIPO-TYPE

CODICE OMS 07-06-033

COD. Bh 2 447 010 014

COD.

COD.

COD.



TIPO-TYPE

CODICE OMS 07-06-034

COD.

COD.

COD.

COD.

Est. M24x1,5 - Int. 1/4-18 NPTF

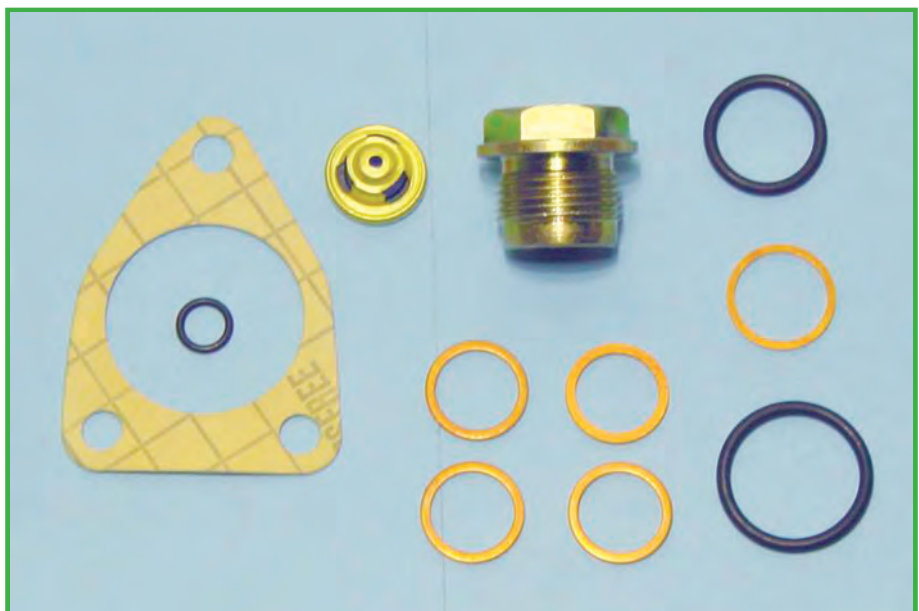

TIPO-TYPE

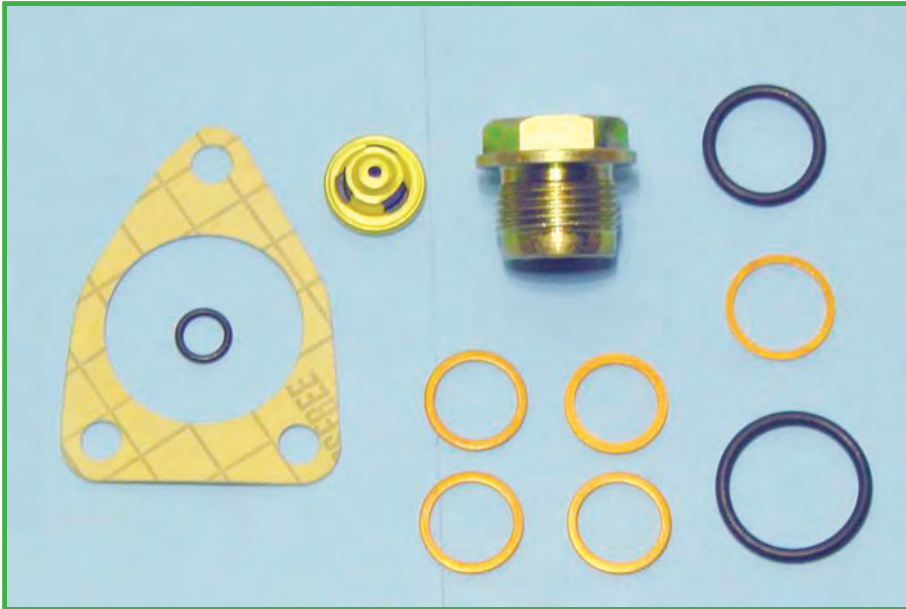

CODICE OMS 07-06-035

COD. _____

COD. _____

COD. _____

COD. _____

Est. M22x1,5 - Int. 1/4-18 NPTF

TIPO-TYPE

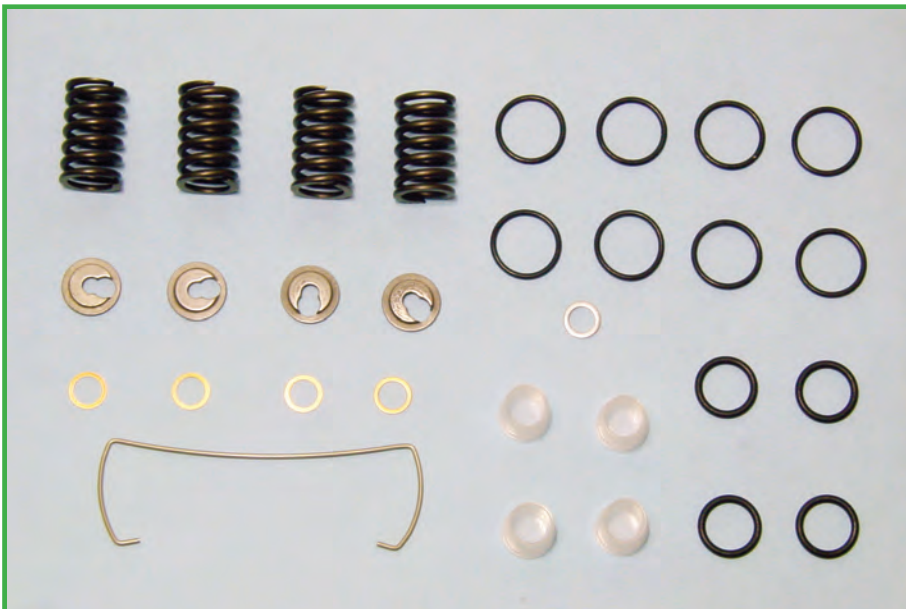

CODICE OMS 07-06-037

COD. Kit Kubota Zexel

COD. _____

COD. _____

COD. _____

TIPO-TYPE 4 cilindri

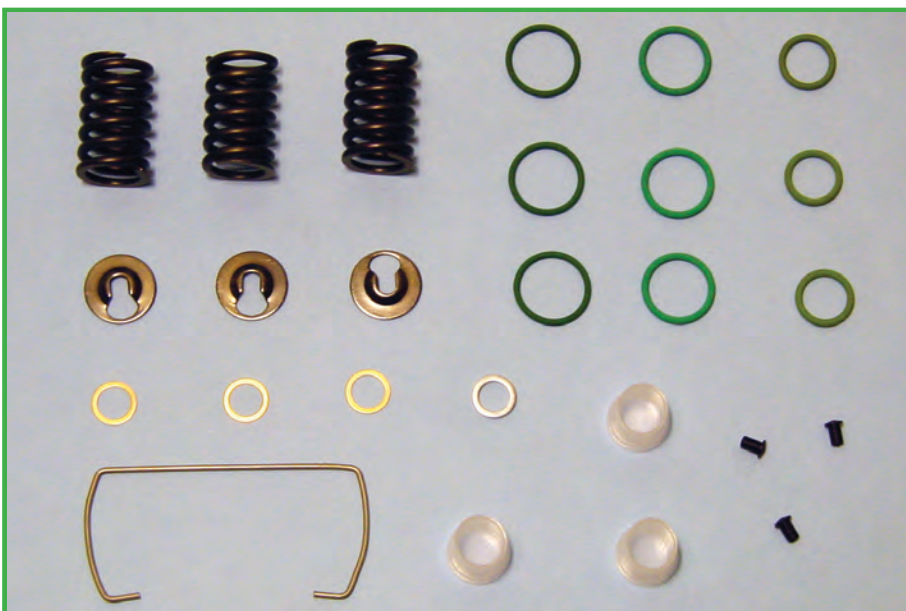

CODICE OMS 07-06-038

COD. Kit Kubota Zexel

COD. _____

COD. _____

COD. _____

TIPO-TYPE 3 cilindri



CODICE OMS 11-23-083

COD. _____
 COD. _____
 COD. _____
 COD. _____

Est. M22x1,5 - Int. 14x1,5

TIPO-TYPE

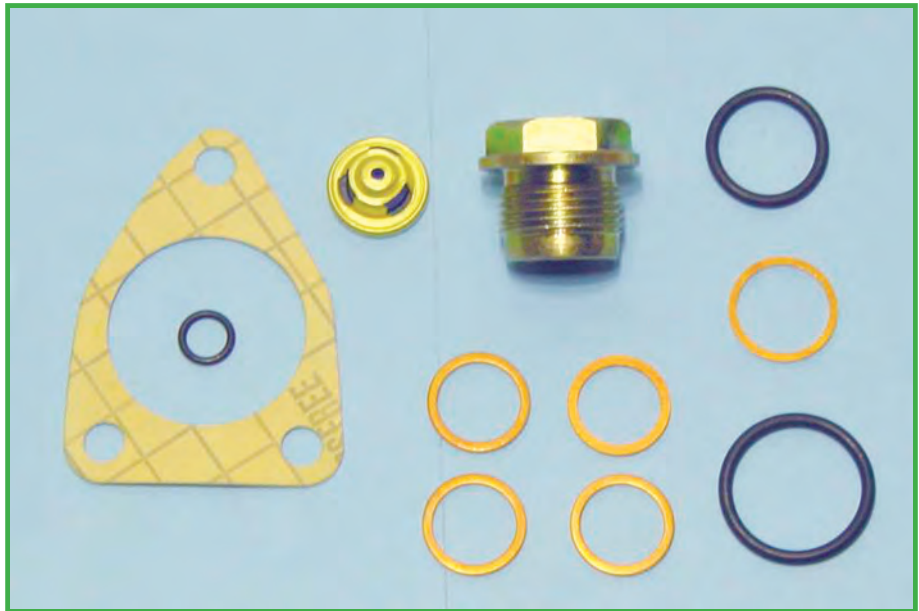

CODICE OMS 11-23-084

COD. _____
 COD. _____
 COD. _____
 COD. _____

Est. M24x1,5 - Int. 14x1,5

TIPO-TYPE

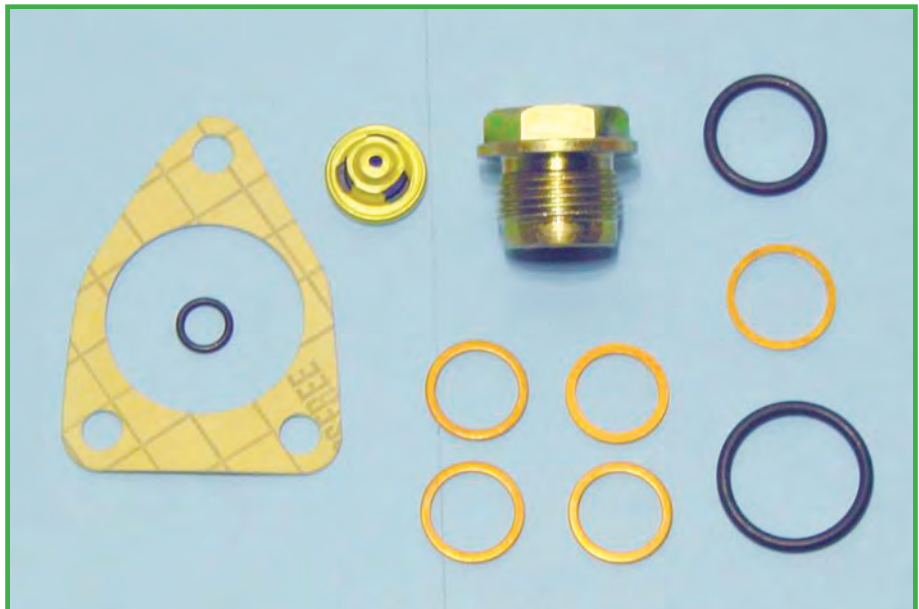



KIT 10-15-***	da pag. 1 a pag. 97
KIT 10-16-***	da pag. 98 a pag. 103
KIT 11-09-***	da pag. 104 a pag. 158
KIT 11-24-***	pag. 159
KIT 02-40-***	pag. 160 - 161
KIT 11-23-***	da pag 162 a pag. 267
	KIT POMPE TANDEM
	pag. 207-209
	0 445 120 ***
	da pag. 209 a pag. 221
	0 445 110 ***
	da pag. 240 a pag. 247
KIT 11-24-032	pag. 268
KIT 05-07-***	da pag. 268 a pag. 273
KIT POMPE Alimentazione	da pag. 274 a pag. 286



OMS srl
COMMON RAIL & DIESEL INJECTION
SPARE PARTS

CATALOGO RICAMBI INIETTORI
INJECTOR DIESEL SPARE
PARTS CATALOGUE



VERSIONE 10.1 2014

BOSCH
DENSO
DELPHI
SIEMENS
CUMMINS
NAVISTAR
DETROIT DIESEL
CATERPILLAR

OMS srl
COMMON RAIL & DIESEL INJECTION
SPARE PARTS

CATALOGO SPESSORI
CALIBRATION SHIMS
SUPLEMENTOS DE CALIBRACIÓN
калибровки прокладки
校準墊片



VERSIONE 12.2 2014

BOSCH
SIEMENS
DENSO
DELPHI

VERSIONE 13.1 2014

OMS srl
COMMON RAIL & DIESEL INJECTION
SPARE PARTS

CATALOGO POMPE
PUMPS CATALOGUE



VERSIONE 13.1 2014

OMS srl
COMMON RAIL & DIESEL INJECTION
SPARE PARTS

CATALOGO KIT
KIT CATALOGUE

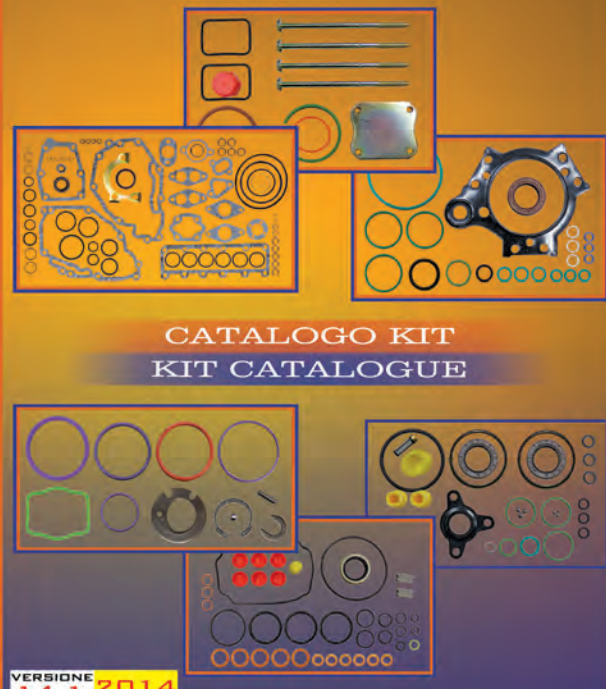

VERSIONE 14.1 2014



Via Piave 15 - 25015 Desenzano del Garda (Brescia) Italia
Tel. +39 030 9127051 -Fax +39 030 9124070
oms@omsnet.it - www.omsnet.it